

STANDARD RECOVERY DIODES

Stud Version

Features

- Diffused diode
- High voltage ratings up to 1200V
- High surge current capabilities
- Stud cathode and stud anode version
- Hermetic metal case

150A

Typical Applications

- Welders
- Power supplies
- Machine tool controls
- High power drives
- Medium traction applications
- Battery charges
- Free-wheeling diodes

Major Ratings and Characteristics

Parameters	150U(R)..	Units
$I_{F(AV)}$	150	A
@ T_C	125	°C
$I_{F(RMS)}$	235	A
I_{FSM} @ 50Hz	3000	A
@ 60Hz	3140	A
I^2t @ 50Hz	45	KA ² s
@ 60Hz	41	KA ² s
V_{RRM} range	600 and 1200	V
T_J	- 40 to 180	°C

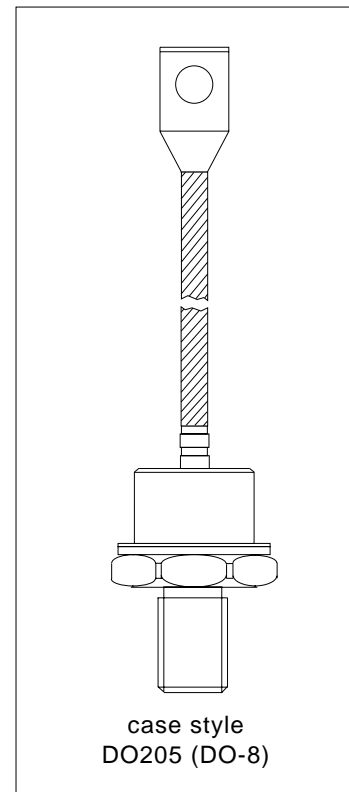

150U(R).. Series

Bulletin I2025 rev. D 03/03

International
IR Rectifier

ELECTRICAL SPECIFICATIONS

Voltage Ratings

Type number	Voltage Code	V_{RRM} , maximum repetitive peak reverse voltage V	V_{RSM} , maximum non-repetitive peak rev. voltage V	I_{RRM} max. @ $T_J = T_J$ max. mA
150U(R)..	60	600	700	15
	80	800	900	
	100	1000	1100	
	120	1200	1300	

Forward Conduction

Parameter	150U(R)..	Units	Conditions		
$I_{F(AV)}$ Max. average forward current @ Case temperature	150	A	180° conduction, half sine wave		
	125	°C			
$I_{F(RMS)}$ Max. RMS forward current	235	A	Dc @ 110°C		
I_{FSM} Max. peak, one-cycle forward, non-repetitive surge current	3000	A	t = 10ms	No voltage reapplied	Sinusoidal half wave, Initial $T_J = T_J$ max.
	3140		t = 8.3ms		
I^2t Maximum I^2t for fusing	45	KA ² s	t = 10ms	No voltage reapplied	
	41		t = 8.3ms		
r_f Slope resistance	0.97	mΩ	@ $T_J = T_J$ max.		
$V_{F(T0)}$ Threshold voltage	0.80	V			
V_{FM} Max. forward voltage drop	1.47	V	$I_{pk} = 600A$, $T_J = 25°C$, $t_p = 10ms$ sinusoidal wave		

Thermal and Mechanical Specifications

Parameter	150U(R)..	Units	Conditions
T_J Max. junction operating temperature range	-40 to 180	°C	
T_{stg} Max. storage temperature range	-40 to 180		
R_{thJC} Max. thermal resistance, junction to case	0.3	K/W	DC operation
R_{thCS} Max. thermal resistance, case to heatsink	0.1		Mounting surface, smooth, flat and greased
T Max. allowed mounting torque +0 -20%	17	Nm	Not lubricated threads
	14.5		Lubricated threads
wt Approximate weight	130	g	
Case style	DO-205 (DO-8)		See Outline Table

ΔR_{thJC} Conduction

(The following table shows the increment of thermal resistance R_{thJC} when devices operate at different conduction angles than DC)

Conduction angle	Sinusoidal conduction	Rectangular conduction	Units	Conditions
180°	0.031	0.023	K/W	$T_J = T_J$ max.
120°	0.038	0.040		
90°	0.048	0.053		
60°	0.071	0.075		
30°	0.120	0.121		

Ordering Information Table

Device Code						
15	0	U	R	120	D	L
(1)	(2)	(3)	(4)	(5)	(6)	(7)

- 1** - 15 = Essential Part Number
- 2** - 0 = Standard Device
- 3** - U = Stud Normal Polarity (Cathode to Stud)
- 4** - None = Stud Normal Polarity (Cathode to Stud)
 R = Stud Reverse Polarity (Anode to Stud)
- 5** - Voltage code: Code x 10 = V_{RRM} (See Voltage Ratings table)
- 6** - Diffused diode
- 7** - L = Stud base 1/2" - 20UNF-2A threads
 None = Stud base 3/8" - 24UNF-2A threads

NOTE: For Metric Device M12 x 1.75 Contact Factory

Outline Table

GLASS-METAL SEAL

16.5 (0.65) MAX.

2.6 (0.10) MAX.

6.5 (0.26) MIN.

35 (1.38) MAX.

DIA. 8.5 (0.33) NOM.

C.S. 16mm²
(0.015 s.i.)

165 (6.49) MIN.
170 (6.69) MAX.

55 (2.16) MIN.

DIA. 23.5 (0.93) MAX.

24 (0.94) MAX.

17 (0.69) MAX.

3/8"-24UNF-2A *

150U(R) Series
 Conforms to JEDEC DO-205 (DO-8)
 All dimensions in millimeters (inches)

* FOR METRIC DEVICE M12 x 1.75
 * FOR STUD BASE 1/2" - 20UNF-2A THREADS; refer "Ordering Information Table"

150U(R).. Series

Bulletin I2025 rev. D 03/03

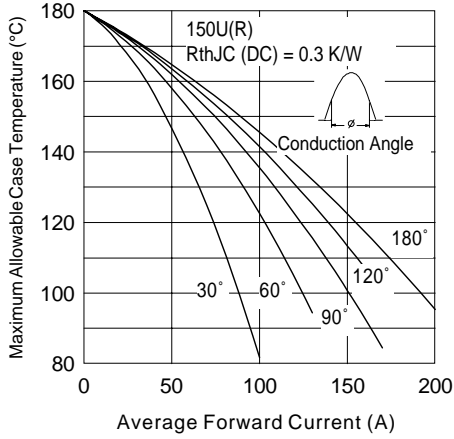

Fig. 1 - Current Ratings Characteristics

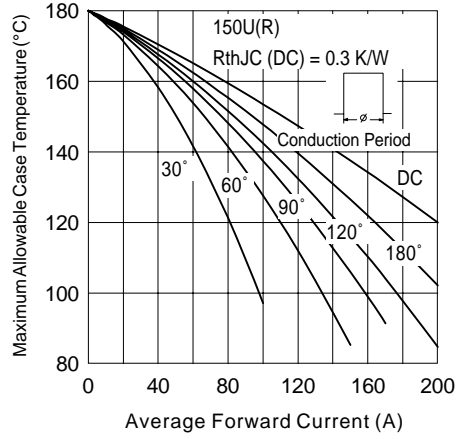

Fig. 2 - Current Ratings Characteristics

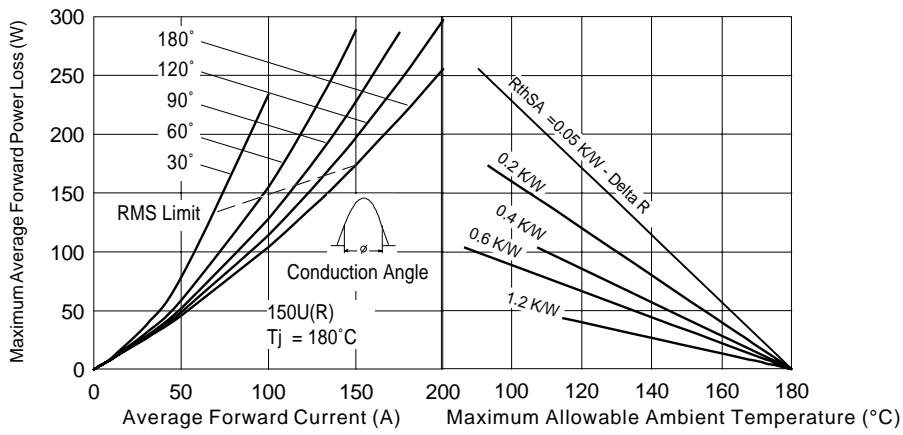

Fig. 3 - Forward Power Loss Characteristics

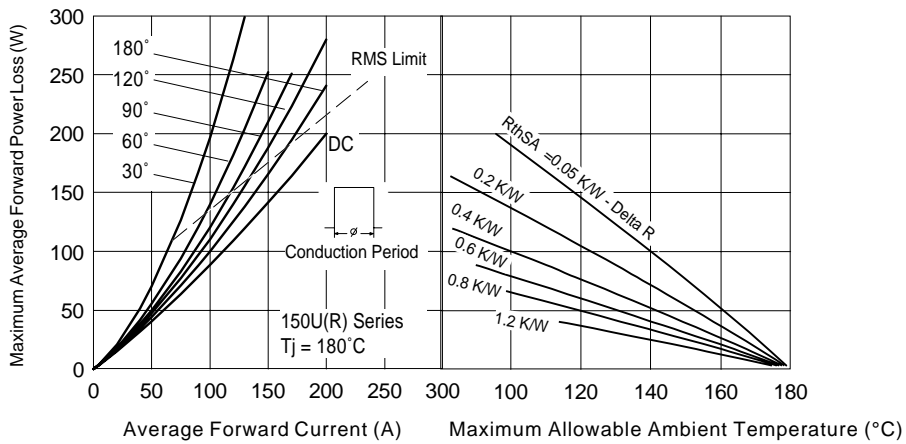
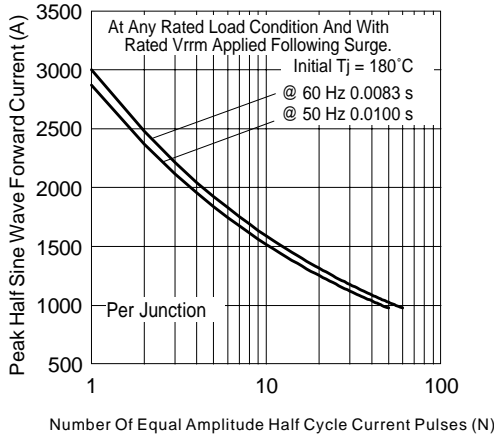
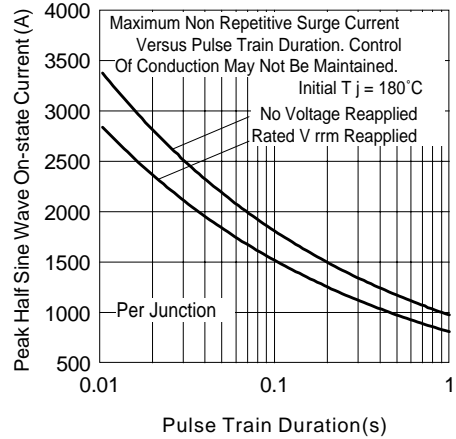

Fig. 4 - Forward Power Loss Characteristics



Number Of Equal Amplitude Half Cycle Current Pulses (N)

Fig. 5 - Maximum Non-Repetitive Surge Current



Pulse Train Duration(s)

Fig. 6 - Maximum Non-Repetitive Surge Current

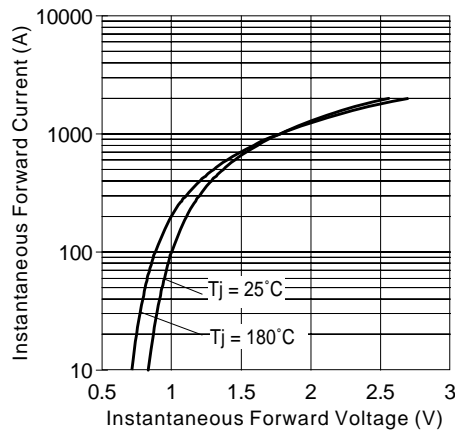

Fig. 7 - Forward Voltage Drop Characteristics

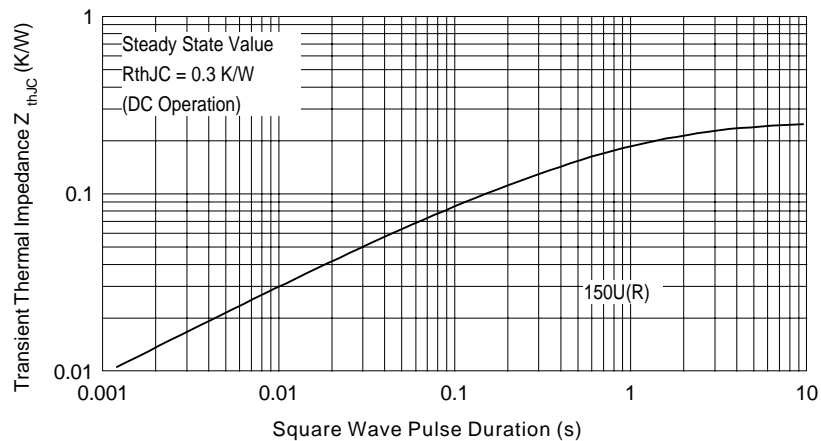

Fig. 8 - Thermal Impedance Z_{thJC} Characteristic

150U(R).. Series

Bulletin I2025 rev. D 03/03

International
IOR Rectifier

Data and specifications subject to change without notice.
This product has been designed and qualified for Industrial Level.
Qualification Standards can be found on IR's Web site.

International
IOR Rectifier

IR WORLD HEADQUARTERS: 233 Kansas St., El Segundo, California 90245, USA Tel: (310) 252-7105
TAC Fax: (310) 252-7309
Visit us at www.irf.com for sales contact information. 03/03