

## 600V / 15A

## Molded Package

### ■ Features

- Small molded package
- Low power loss
- Soft switching with low switching surge and noise
- High reliability, high ruggedness (RBSOA, SCSOA etc.)
- Comprehensive line-up

### ■ Applications

- Inverter for Motor drive
- AC and DC Servo drive amplifier
- Uninterruptible power supply

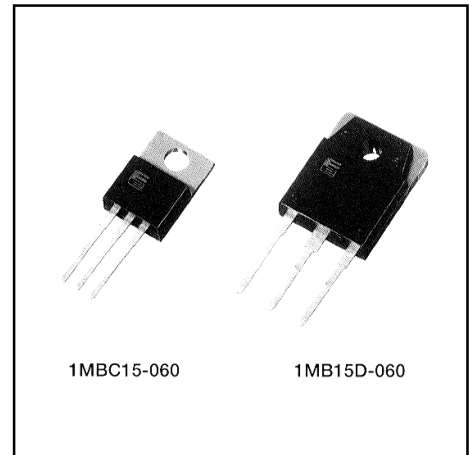

### ■ Maximum ratings and characteristics

- Absolute maximum ratings (at  $T_c=25^\circ\text{C}$  unless otherwise specified)

#### 1MBC15-060 / IGBT

Item	Symbol	Rating	Unit		
Collector-Emitter voltage	$V_{CES}$	600	V		
Gate-Emitter voltage	$V_{GES}$	$\pm 20$	V		
Collector current	DC	$T_c=25^\circ\text{C}$	$I_{C25}$	24	A
		$T_c=80^\circ\text{C}$	$I_{C80}$	15	A
	1ms	$T_c=25^\circ\text{C}$	$I_{cp}$	96	A
Max. power dissipation(IGBT)	$P_c$	90	W		
Operating temperature	$T_j$	+150	$^\circ\text{C}$		
Storage temperature	$T_{stg}$	-40 to +150	$^\circ\text{C}$		
Screw torque	-	40	N·m		

#### 1MB15D-060 / IGBT+FWD

Item	Symbol	Rating	Unit		
Collector-Emitter voltage	$V_{CES}$	600	V		
Gate-Emitter voltage	$V_{GES}$	$\pm 20$	V		
Collector current	DC	$T_c=25^\circ\text{C}$	$I_{C25}$	33	A
		$T_c=100^\circ\text{C}$	$I_{C100}$	15	A
	1ms	$T_c=25^\circ\text{C}$	$I_{cp}$	132	A
Max. power dissipation (IGBT)	$P_c$	120	W		
Max. power dissipation (FWD)	$P_c$	60	W		
Operating temperature	$T_j$	+150	$^\circ\text{C}$		
Storage temperature	$T_{stg}$	-40 to +150	$^\circ\text{C}$		
Screw torque	-	50	N·m		

### ■ Equivalent Circuit Schematic

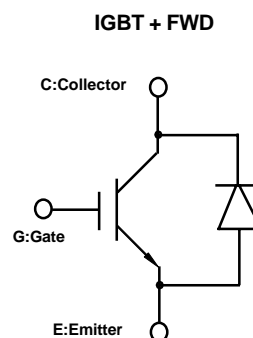
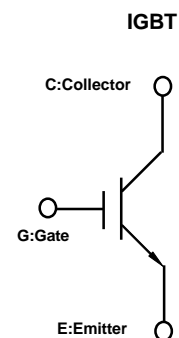

● Electrical characteristics (at Tj=25°C unless otherwise specified)

1MBC15-060 / IGBT

Item	Symbol	Characteristics			Conditions	Unit
		Min.	Typ.	Max.		
Zero gate voltage collector current	ICES	-	-	1.0	VGE=0V, VCE=600V	mA
Gate-Emitter leakage current	IGES	-	-	20	VCE=0V, VGE=±20V	µA
Gate-Emitter threshold voltage	VGE(th)	5.5	-	8.5	VCE=20V, IC=15mA	V
Collector-Emitter saturation voltage	VCE(sat)	-	-	3.0	VGE=15V, IC=15A	V
Input capacitance	Cies	-	1000	-	VGE=0V	pF
Output capacitance	Coes	-	200	-	VCE=10V	
Reverse transfer capacitance	Cres	-	40	-	f=1MHz	
Turn-on time	ton	-	-	1.2	VCC=300V IC=15A	µs
	tr	-	-	0.6	VGE=±15V	
Turn-off time	toff	-	-	1.0	RG=160 ohm	µs
	tf	-	-	0.35	(Half Bridge)	

1MB15D-060 / IGBT+FWD

Item	Symbol	Characteristics			Conditions	Unit
		Min.	Typ.	Max.		
Zero gate voltage collector current	ICES	-	-	1.0	VGE=0V, VCE=600V	mA
Gate-Emitter leakage current	IGES	-	-	20	VCE=0V, VGE=±20V	µA
Gate-Emitter threshold voltage	VGE(th)	5.5	-	8.5	VCE=20V, IC=15mA	V
Collector-Emitter saturation voltage	VCE(sat)	-	-	3.0	VGE=15V, IC=15A	V
Input capacitance	Cies	-	1000	-	VGE=0V	pF
Output capacitance	Coes	-	200	-	VCE=10V	
Reverse transfer capacitance	Cres	-	40	-	f=1MHz	
Turn-on time	ton	-	-	1.2	VCC=300V, IC=15A	µs
	tr	-	-	0.6	VGE=±15V	
Turn-off time	toff	-	-	1.0	RG=160 ohm	µs
	tf	-	-	0.35	(Half Bridge)	
FWD forward on voltage	VF	-	-	3.0	IF=15A, VGE=0V	V
Reverse recovery time	trr	-	-	0.3	IF=15A, VGE=-10V, di/dt=100A/µs	µs

● Thermal resistance characteristics

1MBC15-060 / IGBT

Item	Symbol	Characteristics			Conditions	Unit
		Min.	Typ.	Max.		
Thermal resistance	Rth(j-c)	-	-	1.38	IGBT	°C/W

1MB15D-060 / IGBT+FWD

Item	Symbol	Characteristics			Conditions	Unit
		Min.	Typ.	Max.		
Thermal resistance	Rth(j-c)	-	-	1.04	IGBT	°C/W
	Rth(j-c)	-	-	2.08	FWD	°C/W

■ Outline drawings, mm

1MBC15-060

TO-110AB

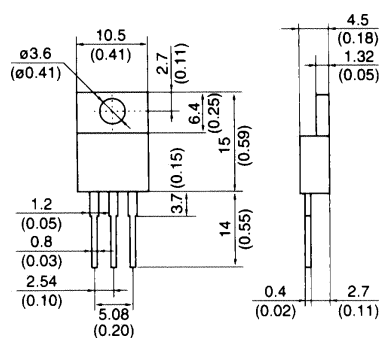

1MB15D-060

TO-3P

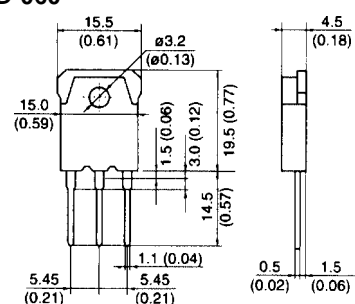

Characteristics

1MBC15-060,1MB15D-060

Collector current vs. Collector-Emmitter voltage

T<sub>j</sub>=25°C

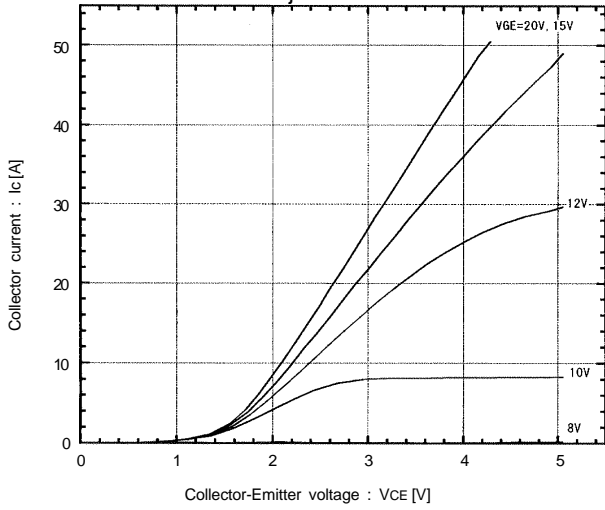

Collector current vs. Collector-Emmitter voltage

T<sub>j</sub>=125°C

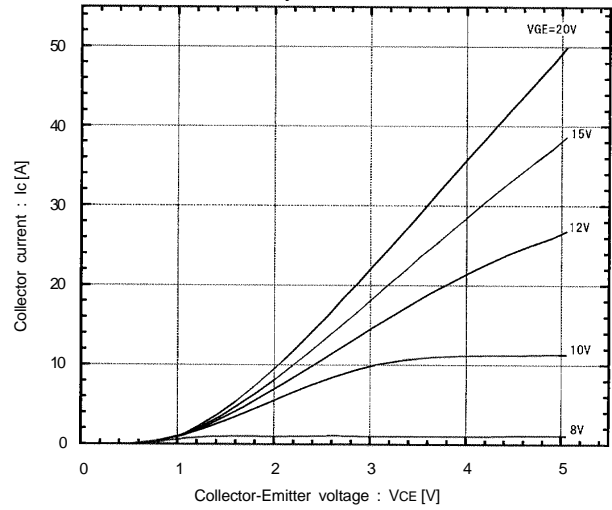

Collector-Emmitter vs. Gate-Emmitter voltage

T<sub>j</sub>=25°C

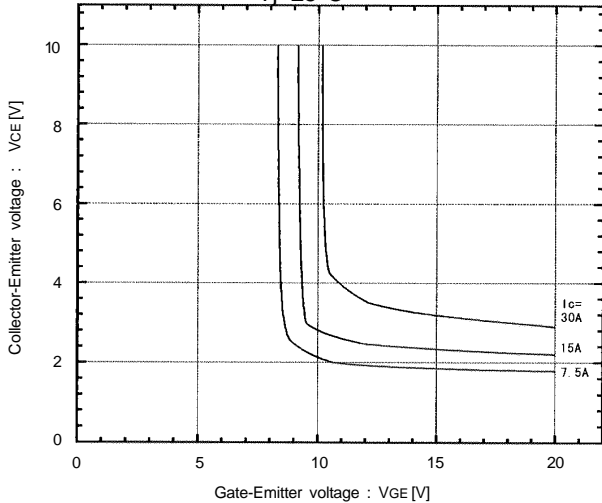

Collector-Emmitter vs. Gate-Emmitter voltage

T<sub>j</sub>=125°C

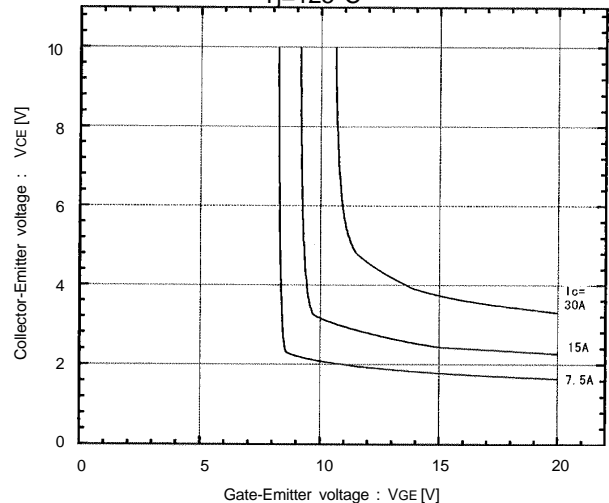

Switching time vs. Collector current

V<sub>CC</sub>=300V, R<sub>G</sub>=160 ohm, V<sub>GE</sub>=±15V, T<sub>j</sub>=25°C

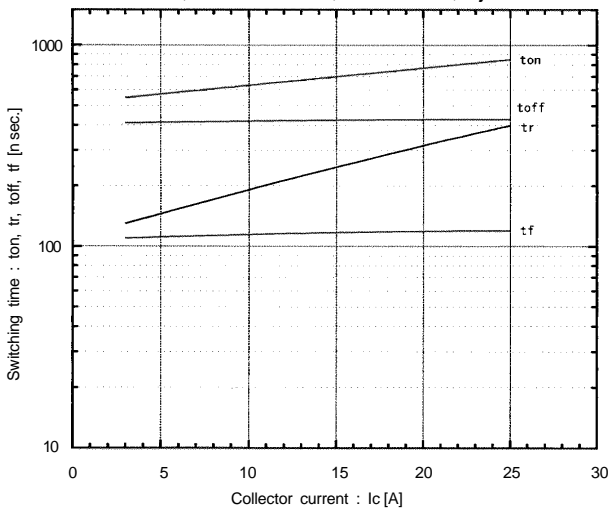

Switching time vs. Collector current

V<sub>CC</sub>=300V, R<sub>G</sub>=160 ohm, V<sub>GE</sub>=±15V, T<sub>j</sub>=125°C

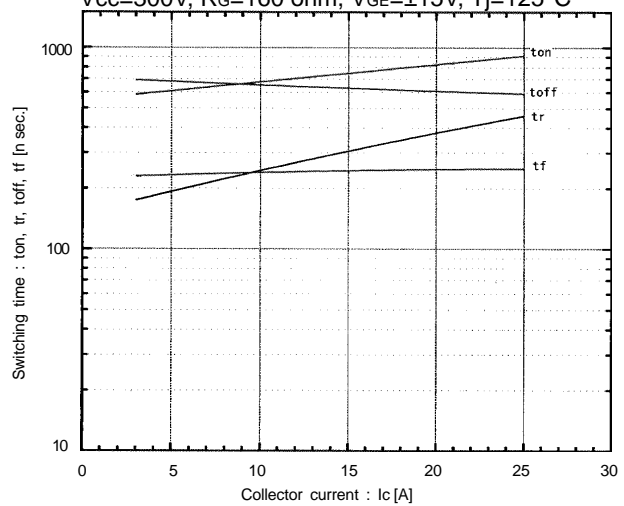

Characteristics

1MBC15-060, 1MB15D-060

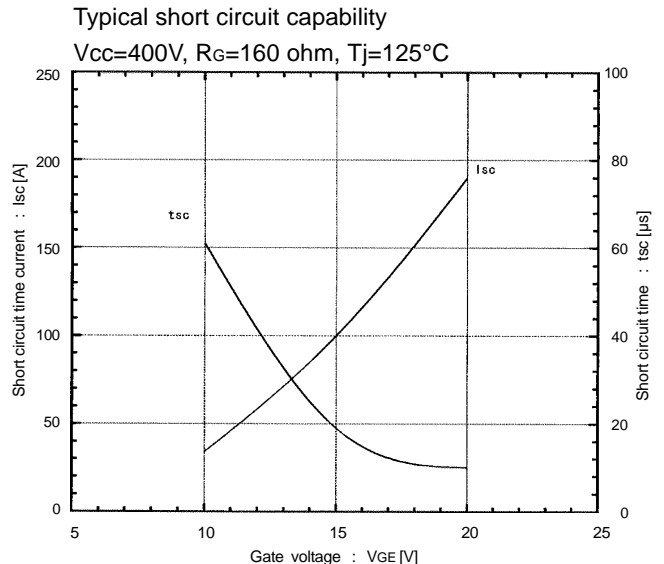
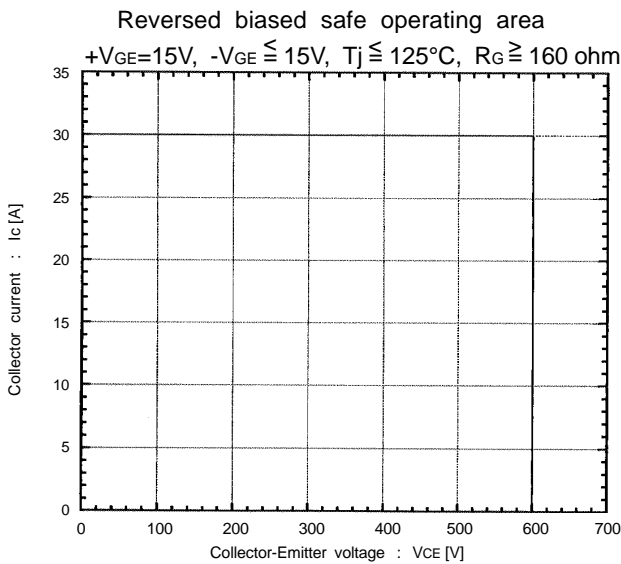
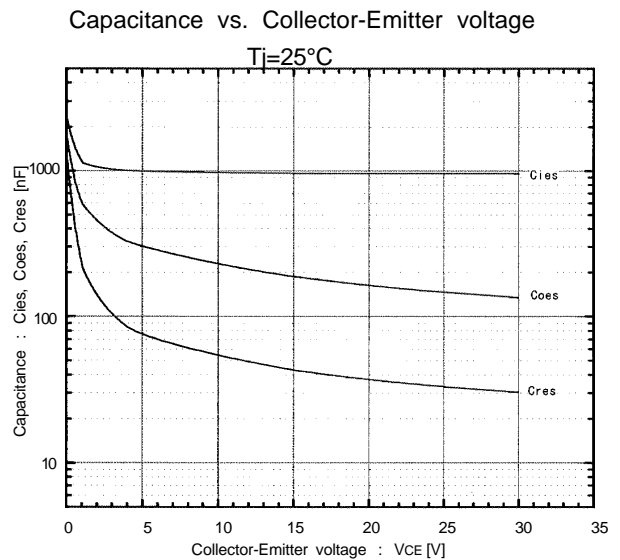
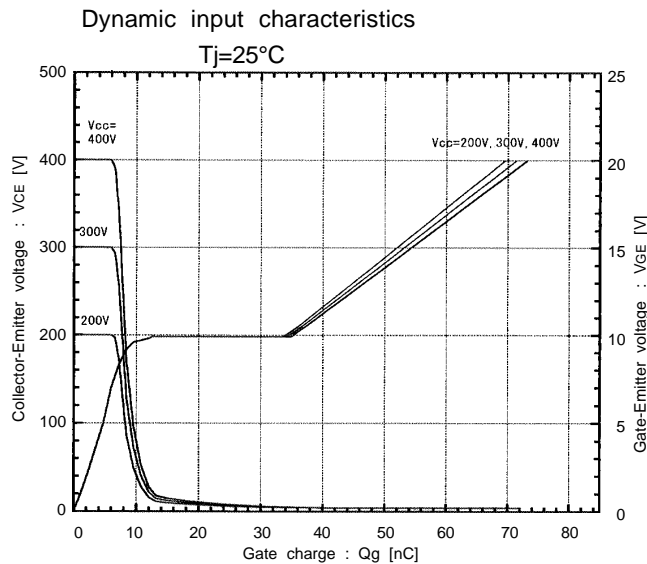
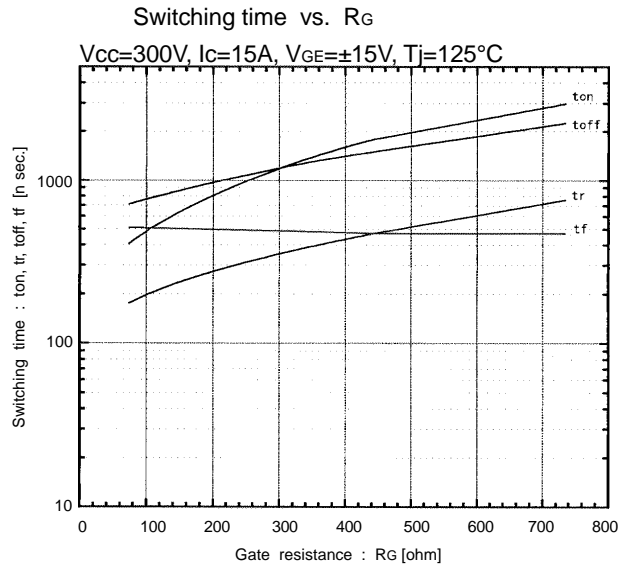
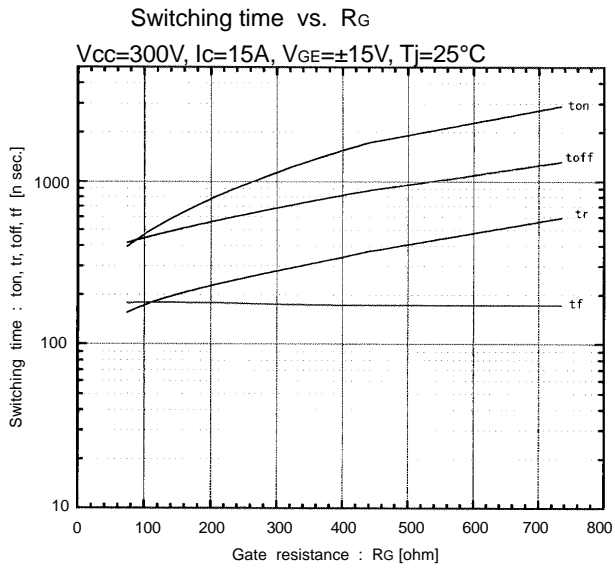

■ Characteristics

1MBC15-060,1MB15D-060

Transient thermal resistance

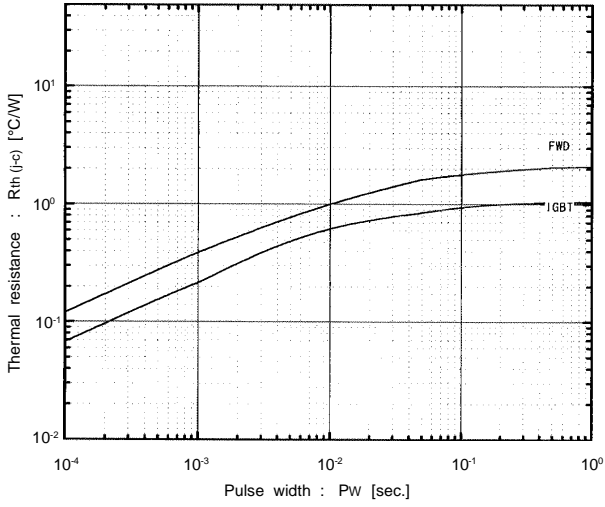

1MB15D-060

Reverse recovery time vs. Forward current

-di/dt=45A / μsec

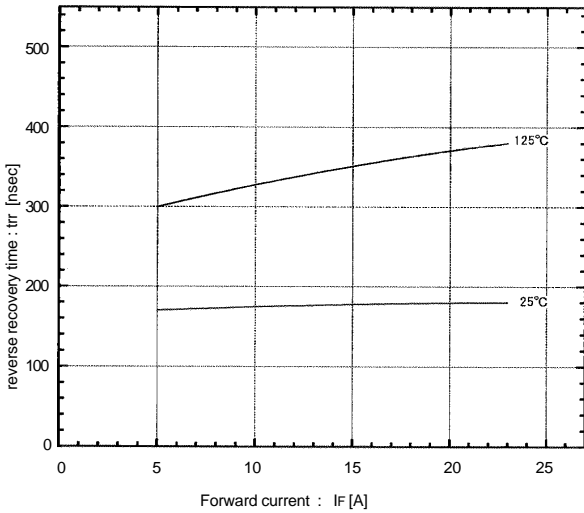

Reverse recovery current vs. Forward current

-di/dt=45A / μsec

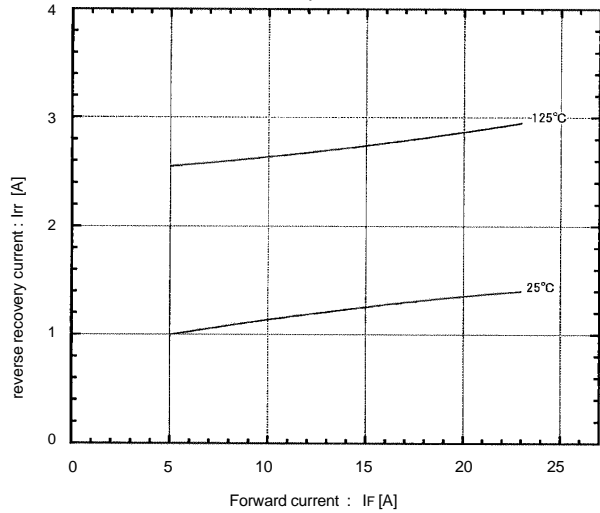

Forward current vs. Forward voltage

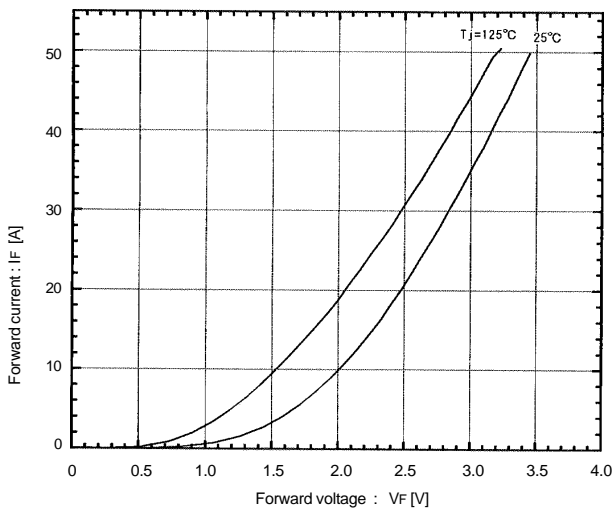

Reverse recovery time characteristics vs. -di/dt

IF=15A, Tj=125°C

