

# SPECIFICATION

DEVICE NAME : IGBT

TYPE NAME : 1MBH10D-120

SPEC. No. : MS5F 4091

DATE : July-15-1997

Fuji Electric Co., Ltd.  
Matsumoto Factory

	DATE	NAME	APPROVED	Fuji Electric Co., Ltd.	
DRAWN	July 15-97	T. Sawada		DWG. NO.	MS5F4091
CHECKED	July 15-97	T. Igarashi			



▪ Scope

This specification is applied to Fuji discrete IGBT 1MBH10D-120  
supplied for Rockwell Automation Co.,Ltd.

▪ Construction

1. Package dimension  
There is a package dimension in 4/14 page .
2. Outview  
There are no remarkable flaws on a product .
3. Indication
  - ① Trademark
  - ② Type Name
  - ③ Lot No.

▪ Ratings and Characteristics

1. There are some ratings and characteristics tables in 4/14 page and 5/14 page .
2. There are some performance curves in from 6/14 page to 14/14 page .

▪ Packing

Packing style follows our packing specification MS5Q0026 .

This material and the information herein is the property of Fuji Electric Co., Ltd. They shall be neither reproduced, copied, lent, or disclosed in any way whatsoever for the use of any third party nor used for the manufacturing purposes without the express written consent of Fuji Electric Co., Ltd.

# Ratings and characteristics of Fuji IGBT

## 1MBH10D-120

### 1. Outline Drawing

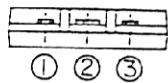
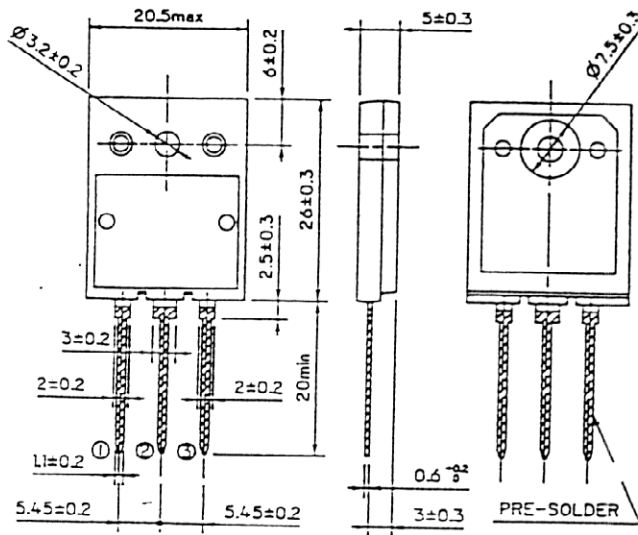

#### CONNECTION

- ① GATE
- ② COLLECTOR
- ③ EMITTER

### 2. Equivalent circuit

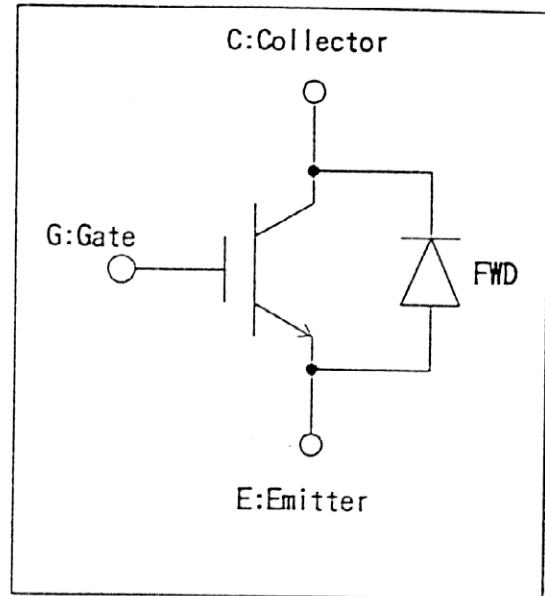

### 3. Absolute maximum ratings (Tc=25°C)

Items		Symbols	Ratings	Units	
Collector-Emitter Voltage		$V_{CES}$	1200	V	
Gate-Emitter Voltage		$V_{GES}$	±22	V	
Collector Current	DC	Tc=25 °C	$I_{C25}$	18	A
		Tc=105°C	$I_{C105}$	10	A
	1ms	Tc=25 °C	$I_{cp}$	48	A
IGBT Max. Power Dissipation		$P_c$	155	W	
FWD Max. Power Dissipation		$P_c$	105	W	
Operating Temperature		$T_j$	+ 150	°C	
Storage Temperature		$T_{stg}$	-40 ~ +150	°C	
Mounting Screw Torque		—	70	N · cm	

Fuji Electric Co., Ltd.

DWG. NO.

MS5F4091

4/14

H04-004-03

4. Electrical Characteristics ( at Tc=25°C unless otherwise specified )

Items	Symbols	Characteristics			Conditions	Unit	
		min.	typ.	max.			
Zero gate voltage Collector Current	$I_{CES}$			1.0	$V_{GE} = 0V$ $V_{CE} = 1200V$	mA	
Gate-Emitter leakage Current	$I_{GES}$			20	$V_{CE} = 0V$ $V_{GE} = \pm 22V$	$\mu A$	
Gate-Emitter Threshold Voltage	$V_{GE(th)}$	5.5		8.5	$V_{CE} = 20V$ $I_C = 10mA$	V	
Collector-Emitter Saturation Voltage	$V_{CE(sat)}$			3.5	$V_{GE} = 15V$ $I_C = 10A$	V	
Input capacitance	$C_{ies}$		1200		$V_{GE} = 0V$	pF	
Output capacitance	$C_{oes}$		250		$V_{CE} = 10V$		
Reverse transfer capacitance	$C_{res}$		80		$f = 1MHz$		
Switching Time	Turn-on time	$t_{on}$		1.2	$V_{CC} = 600V$ $I_C = 10A$ $V_{GE} = \pm 15V$ $R_G = 160\Omega$ (Half Bridge)	$\mu s$	
		$t_r$		0.6			
	Turn-off time	$t_{off}$		1.5			
		$t_f$		0.5			
	Turn-on time	$t_{on}$		0.16			$V_{CC} = 600V$ $I_C = 10A$ $V_{GE} = +15V$ $R_G = 16\Omega$ (Half Bridge)
		$t_r$		0.11			
Turn-off time	$t_{off}$		0.30				
	$t_f$		0.50				
FWD forward voltage drop	$V_F$			3.0	$I_F = 10A$	V	
Reverse recovery time	$t_{rr}$			0.35	$I_F = 10A, V_{GE} = -10V$ $V_R = 200V$ $di/dt = 100A/\mu s$	$\mu s$	

5. Thermal resistance characteristics

Items	Symbols	Characteristics			Conditions	Unit
		min.	typ.	max.		
Thermal resistance	$R_{th(j-c)}$			0.80	IGBT	$^{\circ}C/W$
	$R_{th(j-c)}$			1.19	FWD	

Fuji Electric Co.,Ltd

DWG.NO.

MS5F4091

5/14

Collector Current vs. Collector-Emitter Voltage  
 $T_j=25^\circ\text{C}$

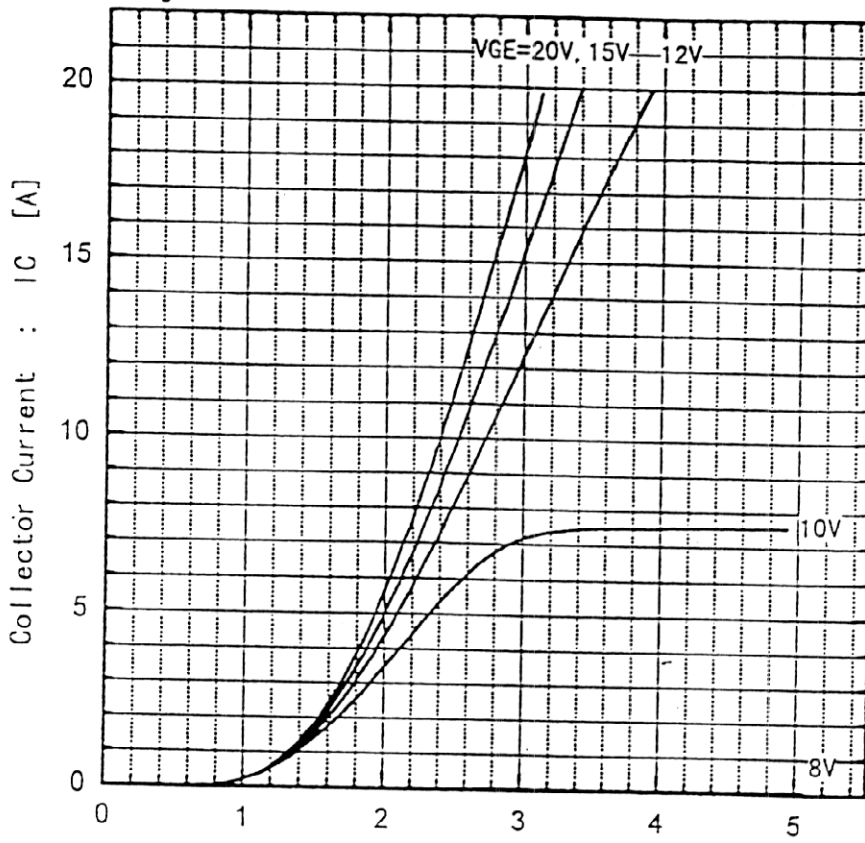

Collector Current vs. Collector-Emitter Voltage  
 $T_j=125^\circ\text{C}$

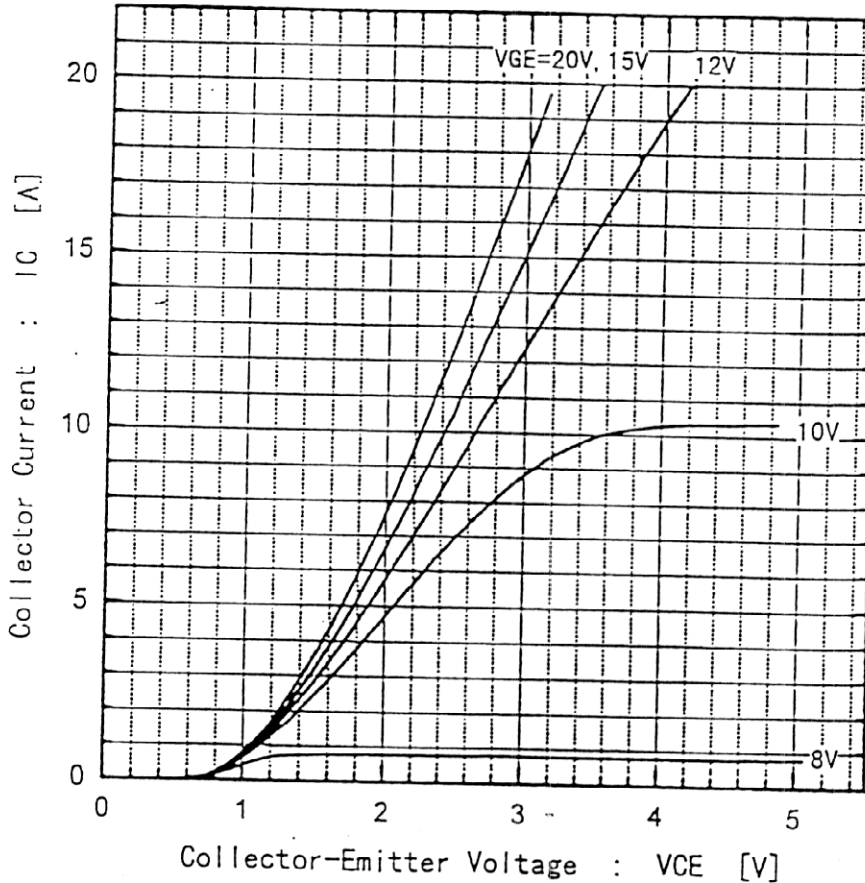

Fuji Electric Co., Ltd.

DWG. NO.

**MS5 F 4091**

6/14

This material and the information herein is the property of Fuji Electric Co., Ltd. They shall be neither reproduced, copied, lent, or disclosed in any way whatsoever for the use of any third party nor used for the manufacturing purposes without the express written consent of Fuji Electric Co., Ltd.

This material and the information herein is the property of Fuji Electric Co. Ltd. They shall be neither reproduced, copied, lent, or disclosed in any way whatsoever for the use of any third party nor used for the manufacturing purposes without the express written consent of Fuji Electric Co., Ltd.

Collector-Emitter Voltage vs Gate-Emitter Voltage  
 $T_j=25^\circ\text{C}$

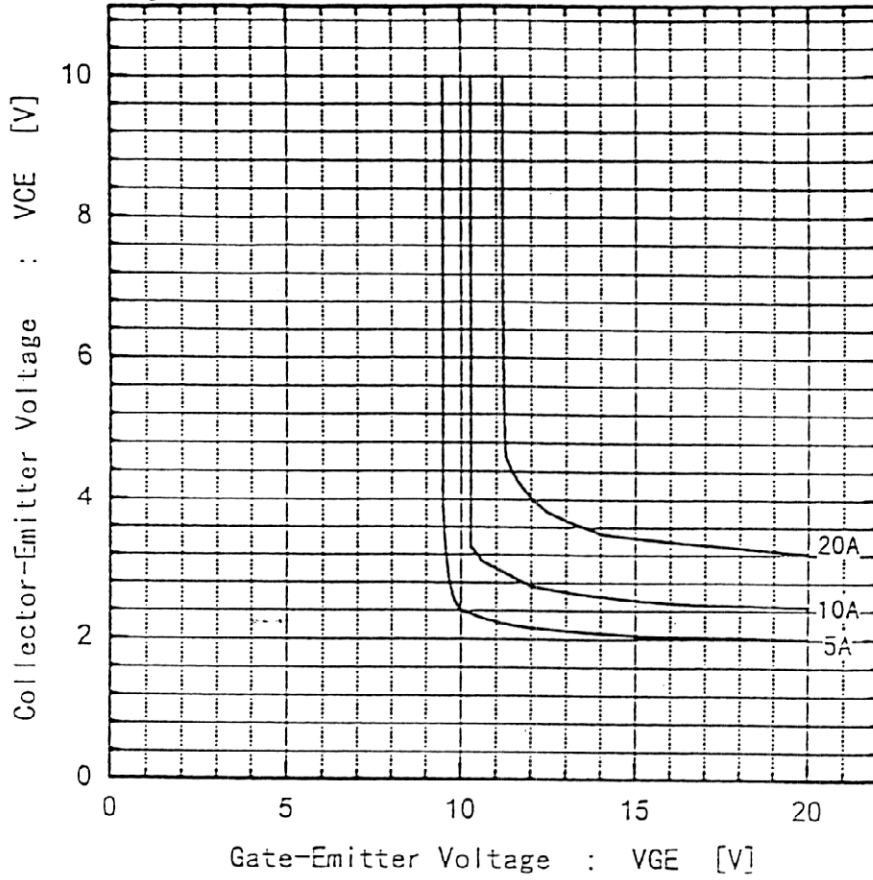

Collector-Emitter Voltage vs Gate-Emitter Voltage  
 $T_j=125^\circ\text{C}$

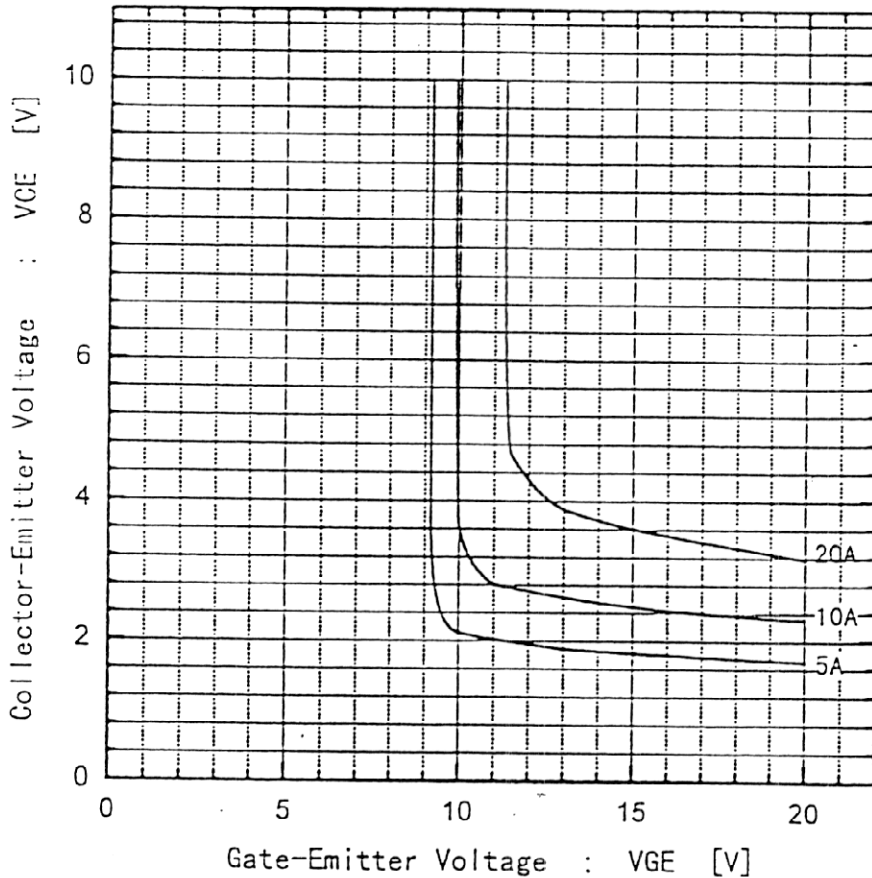

Fuji Electric Co., Ltd.

DWG. NO.

MS5F4091

7/14

H04-004-03

This material and the information herein is the property of Fuji Electric Co., Ltd. They shall be neither reproduced, copied, lent, or disclosed in any way whatsoever for the use of any third party nor used for the manufacturing purposes without the express written consent of Fuji Electric Co., Ltd.

Switching time vs. Collector current  
 $V_{CC}=600V$ ,  $R_G=16\Omega$ ,  $V_{GE}=\pm 15V$ ,  $T_j=25^\circ C$

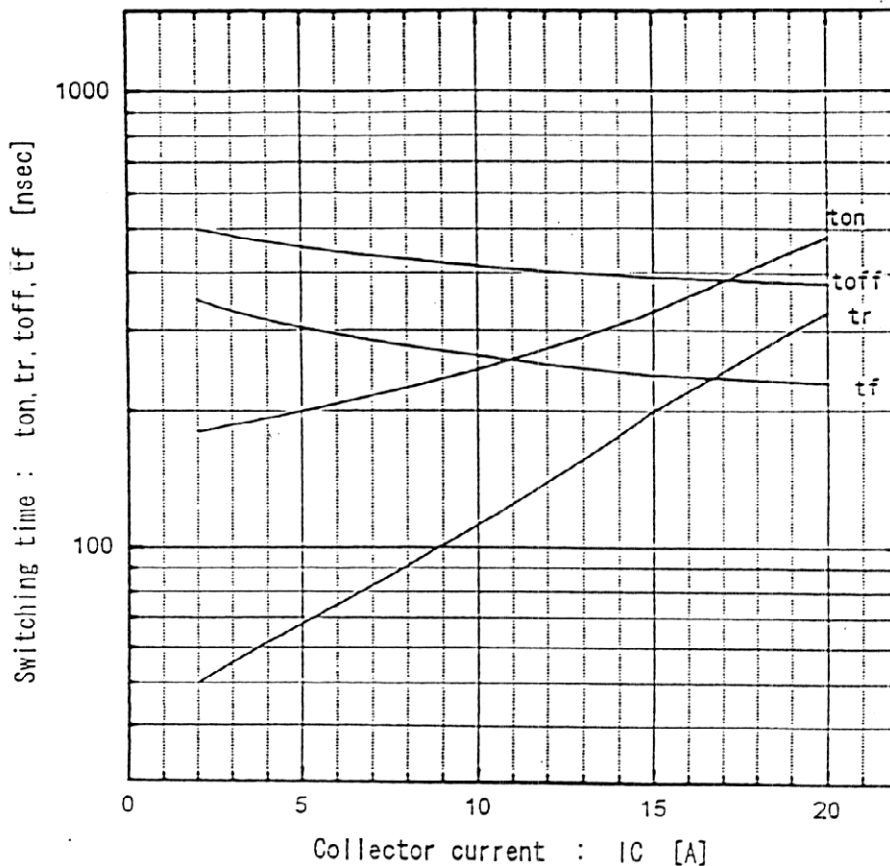

Switching time vs. Collector current  
 $V_{CC}=500V$ ,  $R_G=16\Omega$ ,  $V_{GE}=\pm 15V$ ,  $T_j=25^\circ C$

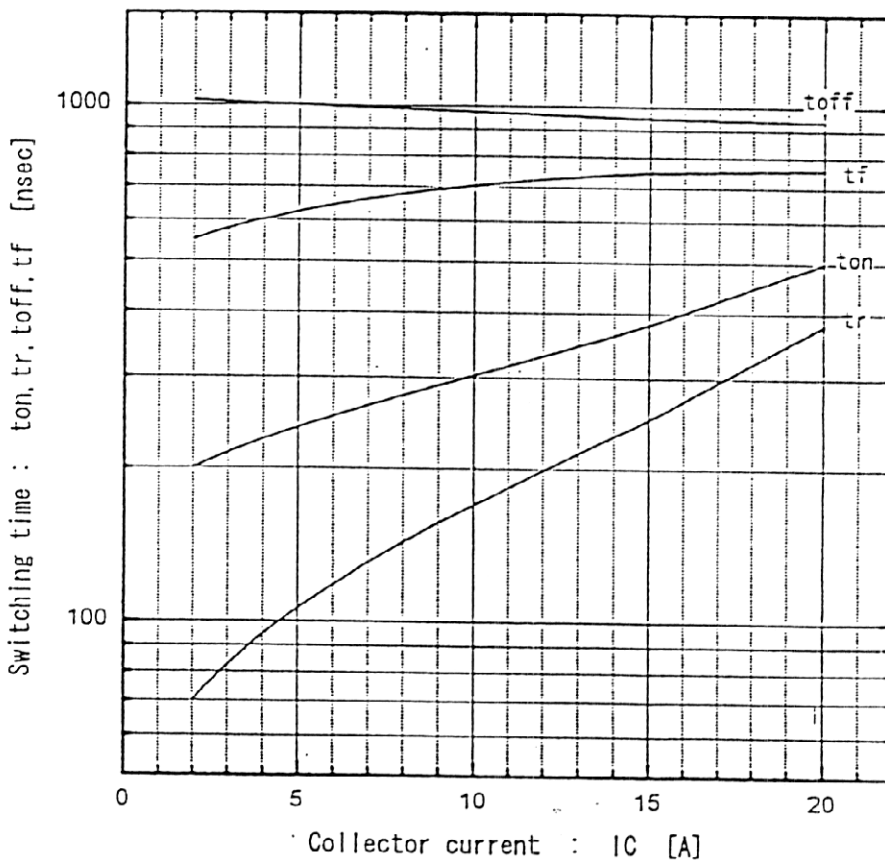

Fuji Electric Co., Ltd.

DWG. NO.

MS5F4091

9/14



This material and the information herein is the property of Fuji Electric Co., Ltd. They shall be neither reproduced, copied, lent, or disclosed in any way whatsoever for the use of any third party nor used for the manufacturing purposes without the express written consent of Fuji Electric Co., Ltd.

Switching time vs.  $R_G$   
 $V_{CC}=600V, I_C=10A, V_{GE}=\pm 15V, T_j=25^\circ C$

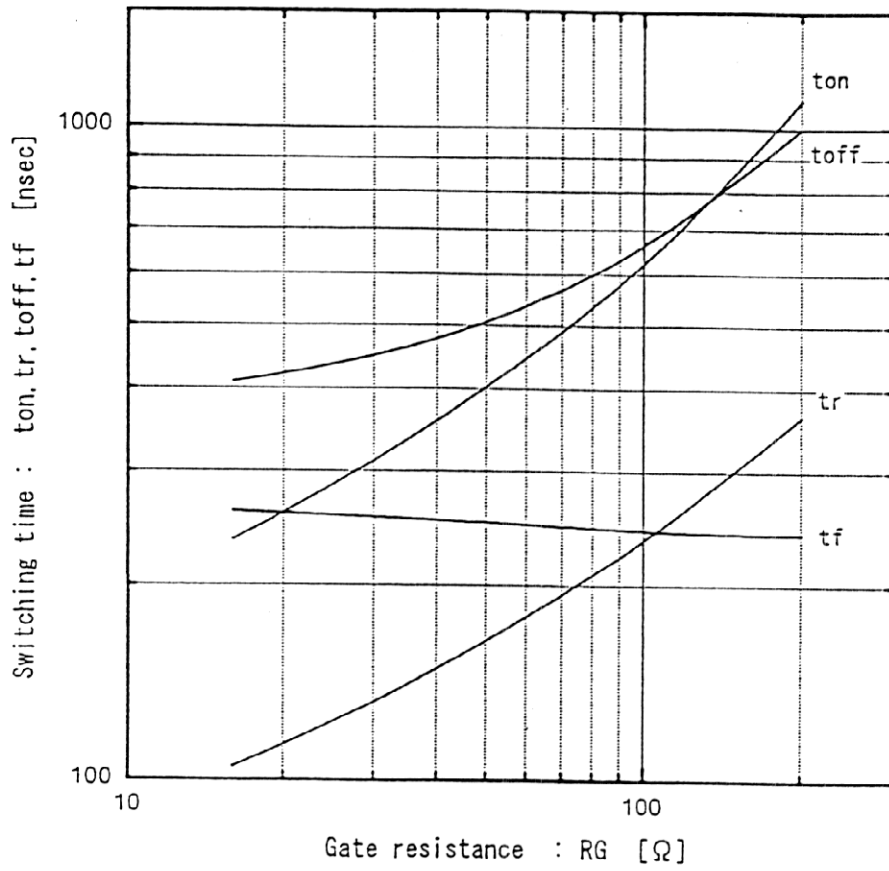

Switching time vs.  $R_G$   
 $V_{CC}=600V, I_C=10A, V_{GE}=\pm 15V, T_j=125^\circ C$

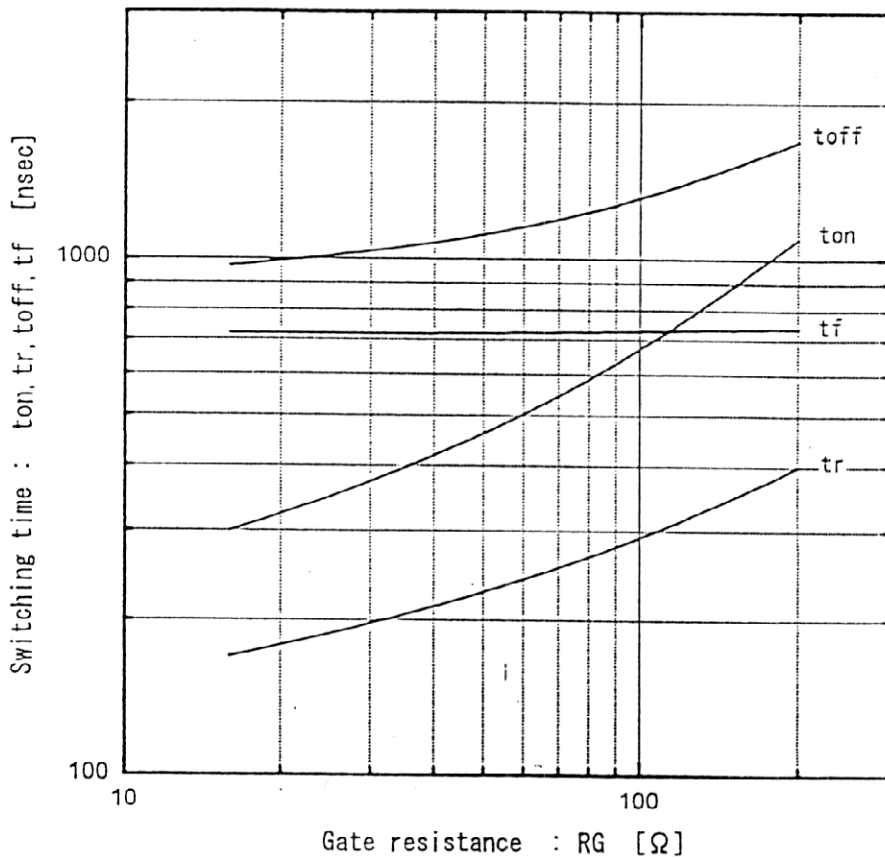

Fuji Electric Co., Ltd.

DWG. NO.

MS5 F 4091

9/14

This material and the information herein is the property of Fuji Electric Co., Ltd. They shall be neither reproduced, copied, lent, or disclosed in any way whatsoever for the use of any third party nor used for the manufacturing purposes without the express written consent of Fuji Electric Co., Ltd.

### Dynamic input characteristics

$T_j = 25^\circ\text{C}$

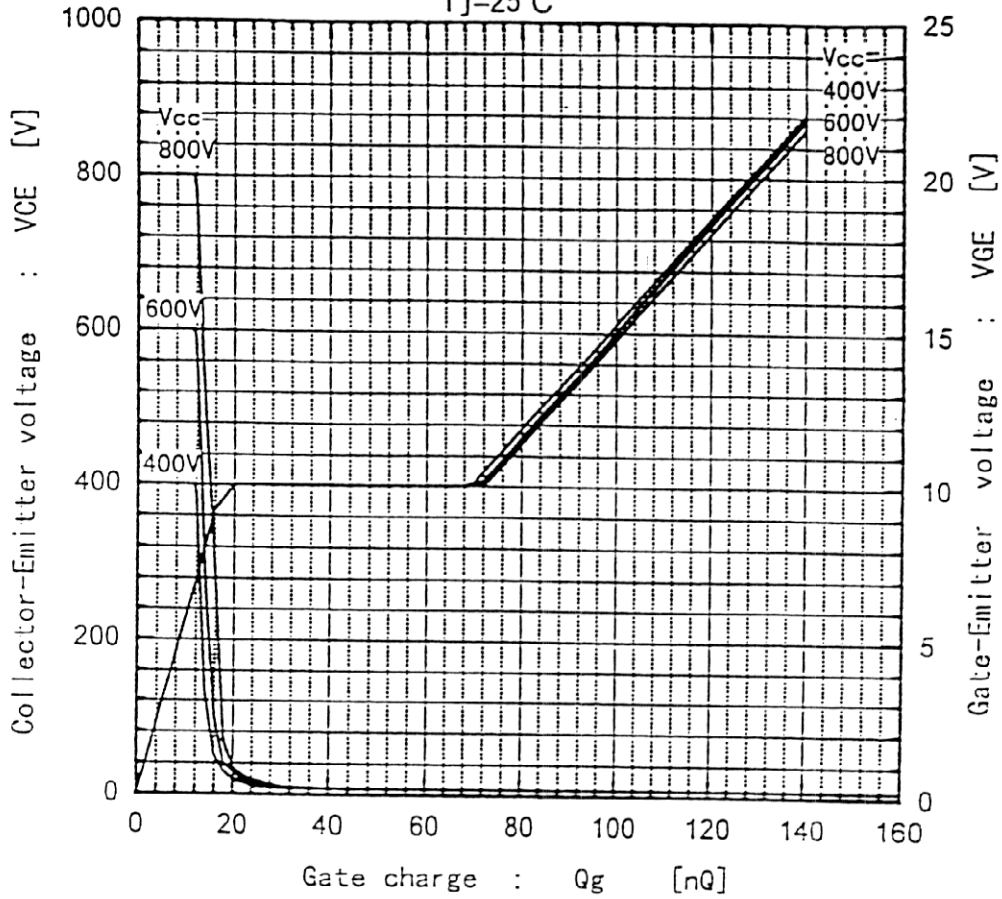

### Capacitance vs. Collector-Emitter voltage

$T_j = 25^\circ\text{C}$

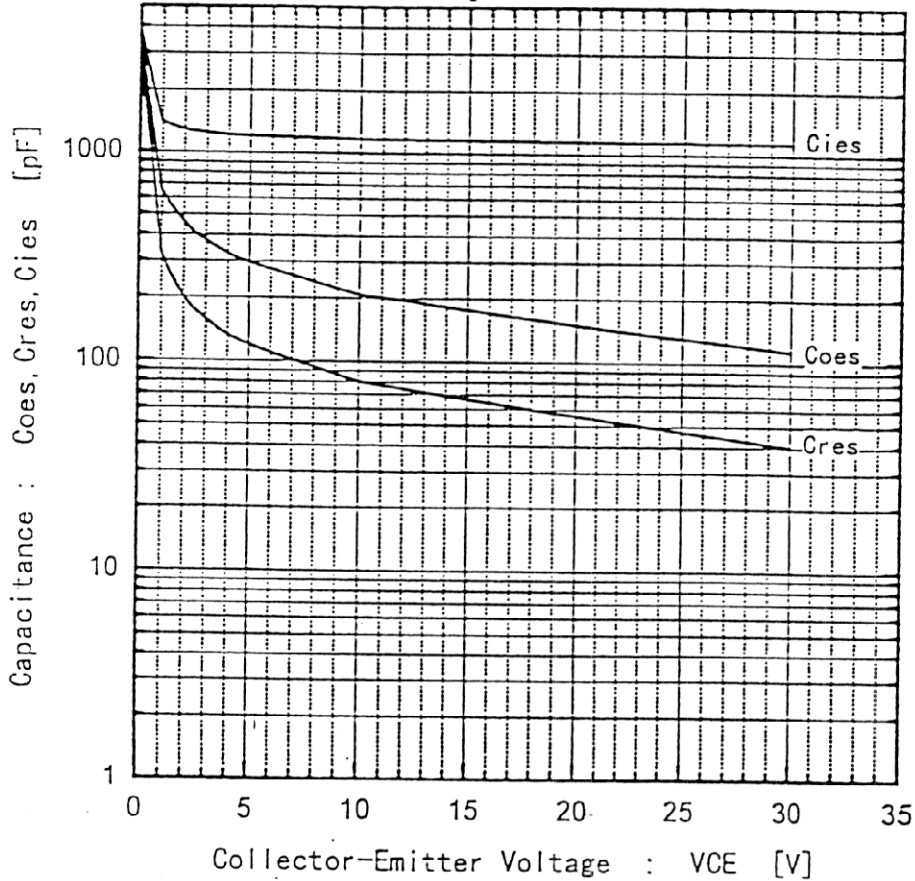

Fuji Electric Co., Ltd.

DWG. NO.

**MS5 F 4091**

10/14

This material and the information herein is the property of Fuji Electric Co., Ltd. They shall be neither reproduced, copied, lent, or disclosed in any way whatsoever for the use of any third party nor used for the manufacturing purposes without the express written consent of Fuji Electric Co., Ltd.

Reverse Biased Safe Operating Area  
 $+V_{GE}=15V, -V_{GE} \leq 15V, T_j \leq 125^\circ C, R_G \geq 16\Omega$

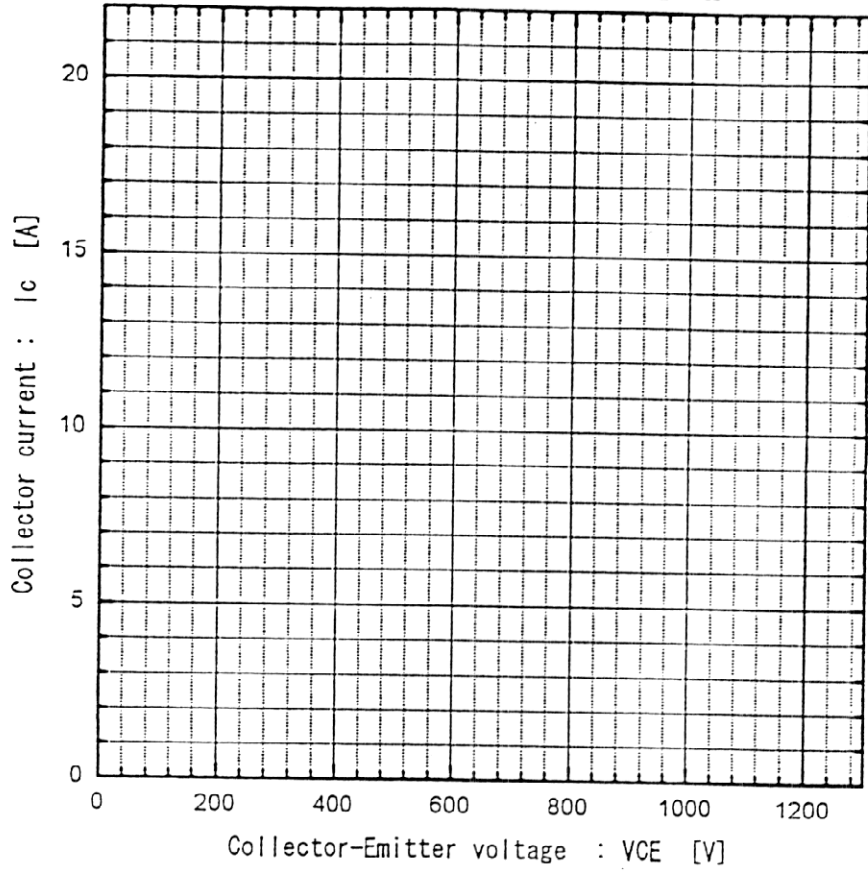

Typical short circuit capability  
 $V_{CC}=800V, R_G=16\Omega, T_j=125^\circ C$

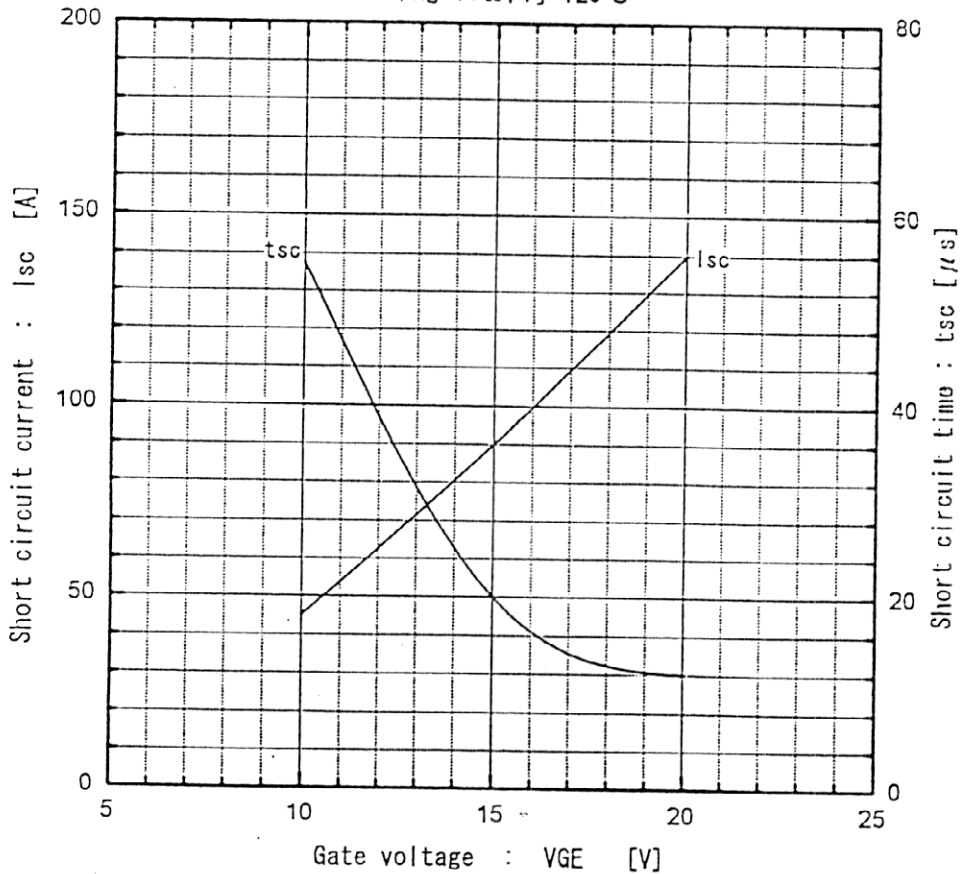

Fuji Electric Co., Ltd.

DWG. NO.

MS5 F 4091



This material and the information herein is the property of Fuji Electric Co. Ltd. They shall be neither reproduced, copied, lent, or disclosed in any way whatsoever for the use of any third party nor used for the manufacturing purposes without the express written consent of Fuji Electric Co., Ltd.

Reverse recovery time vs. Forward current  
 $V_R=200V, -di/dt=100A/\mu sec$

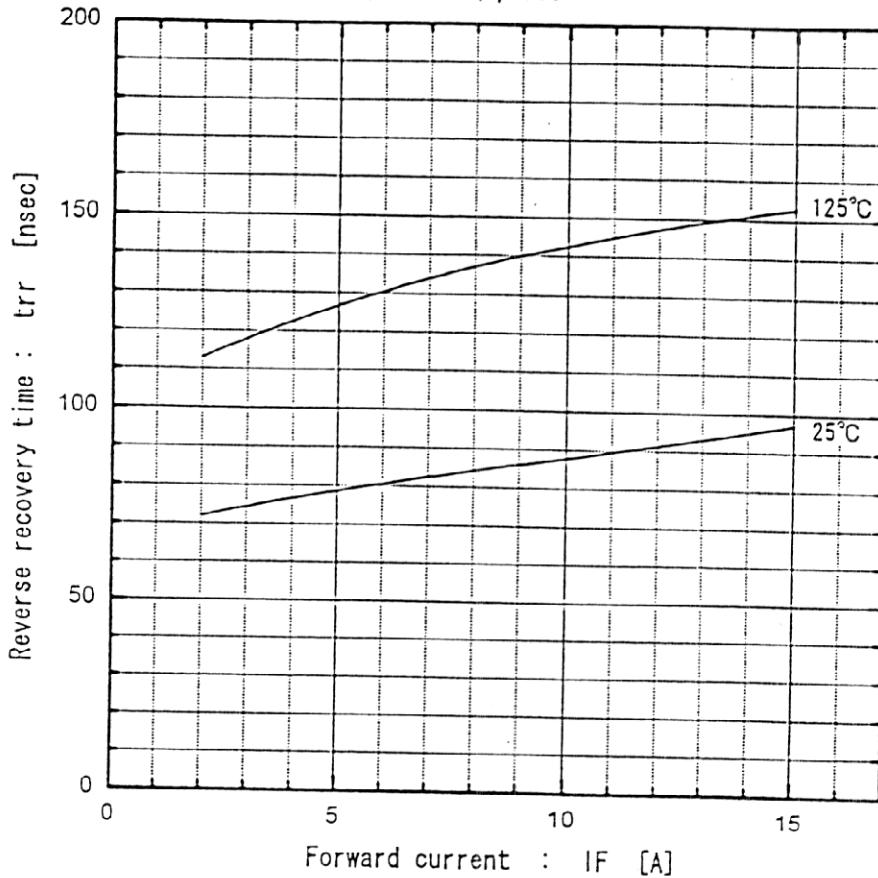

Reverse recovery current vs. Forward current  
 $V_R=200V, -di/dt=100A/\mu sec$

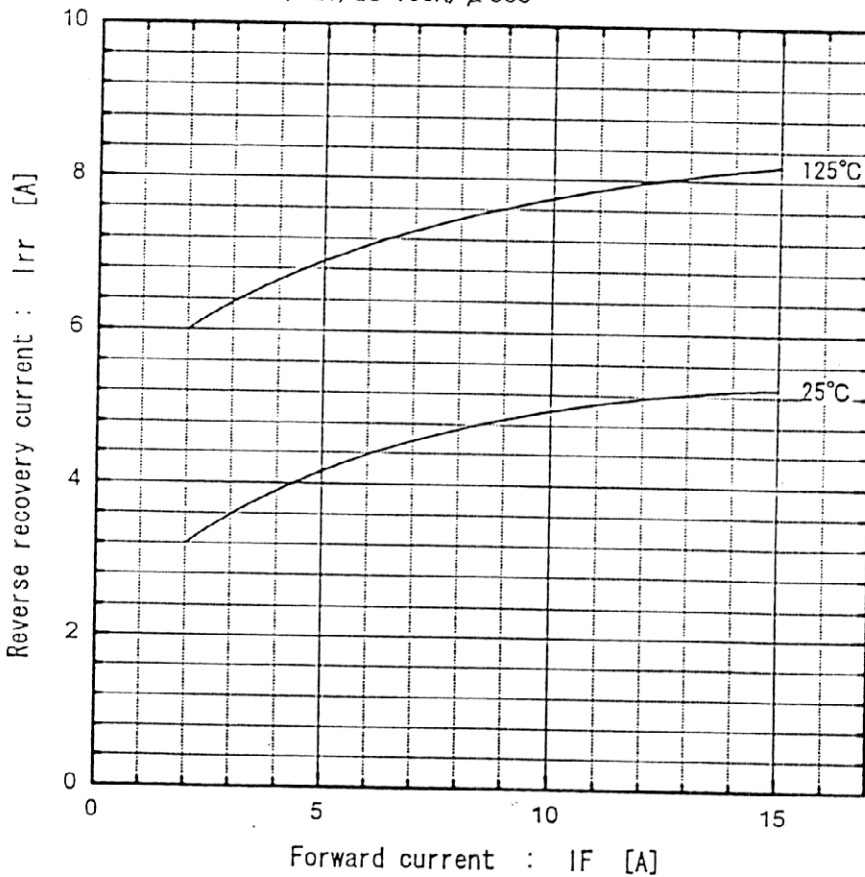

Fuji Electric Co., Ltd

DWG. NO.

MS5 F 4091

13/A

H04-004-03

This material and the information herein is the property of Fuji Electric Co. Ltd. They shall be neither reproduced, copied, lent, or disclosed in any way whatsoever for the use of any third party nor used for the manufacturing purposes without the express written consent of Fuji Electric Co., Ltd.

Forward voltage vs. Forward current

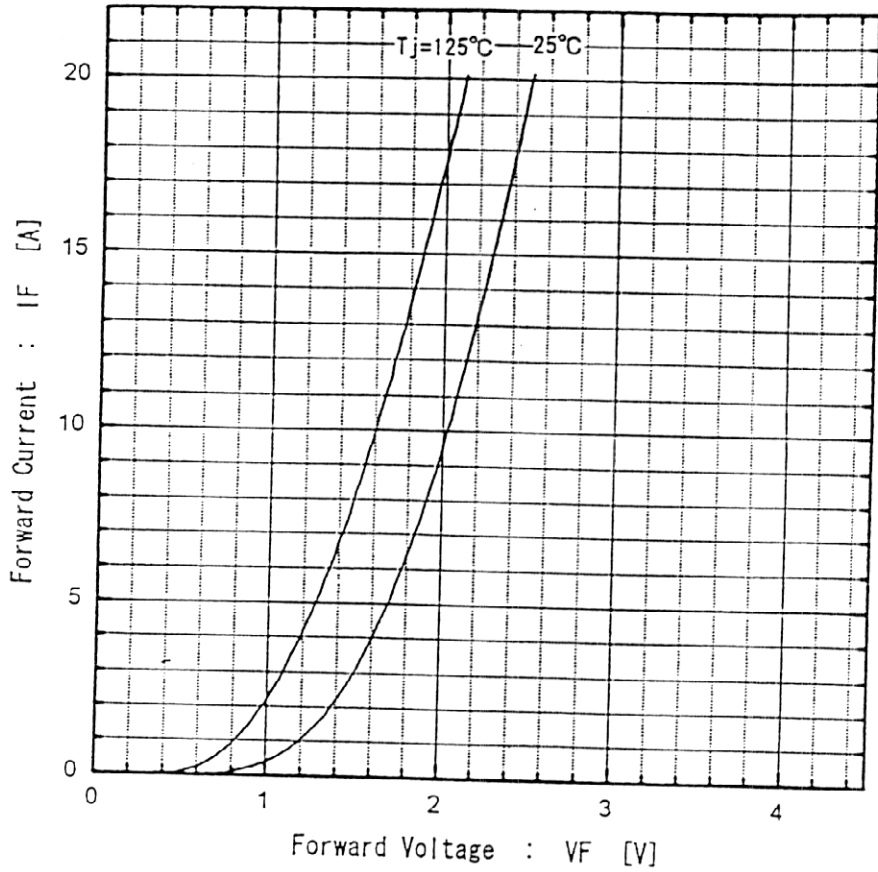

Reverse recovery characteristics vs.  $-di/dt$   
IF=10A, Tj=125°C

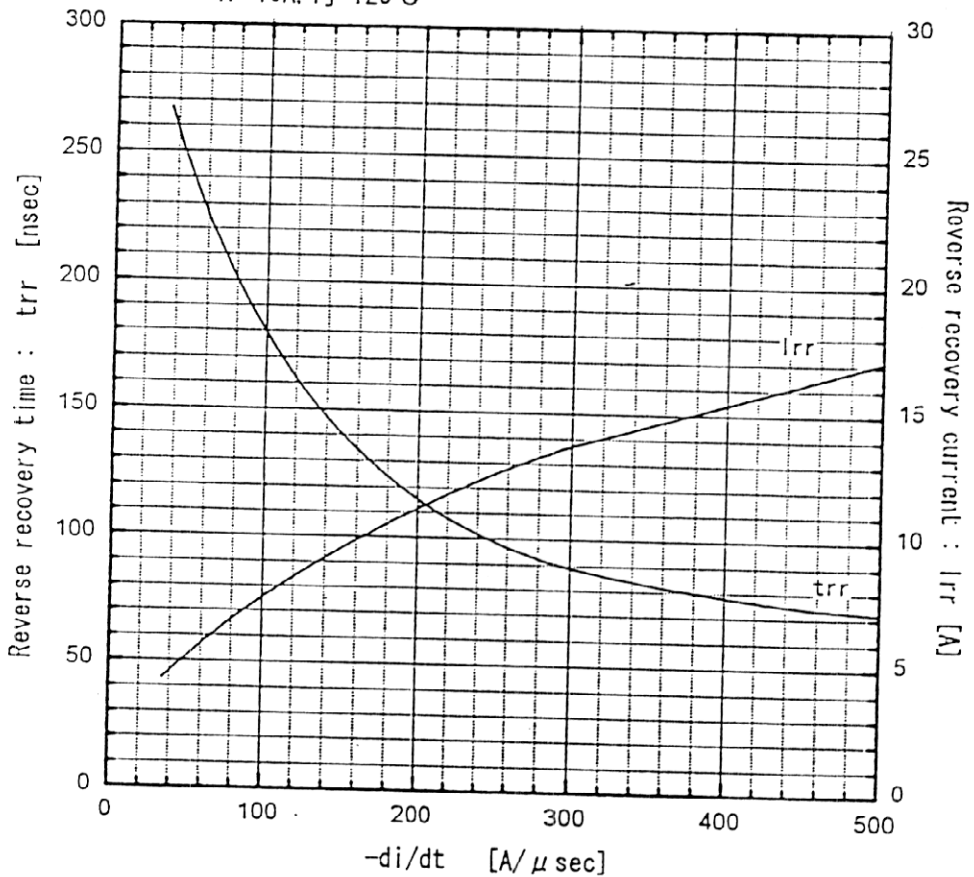

Fuji Electric Co., Ltd.

DWG. NO.

MS5 F 4091

13/14

This material and the information herein is the property of Fuji Electric Co., Ltd. They shall be neither reproduced, copied, lent, or disclosed in any way whatsoever for the use of any third party nor used for the manufacturing purposes without the express written consent of Fuji Electric Co., Ltd.

### Transient thermal resistance

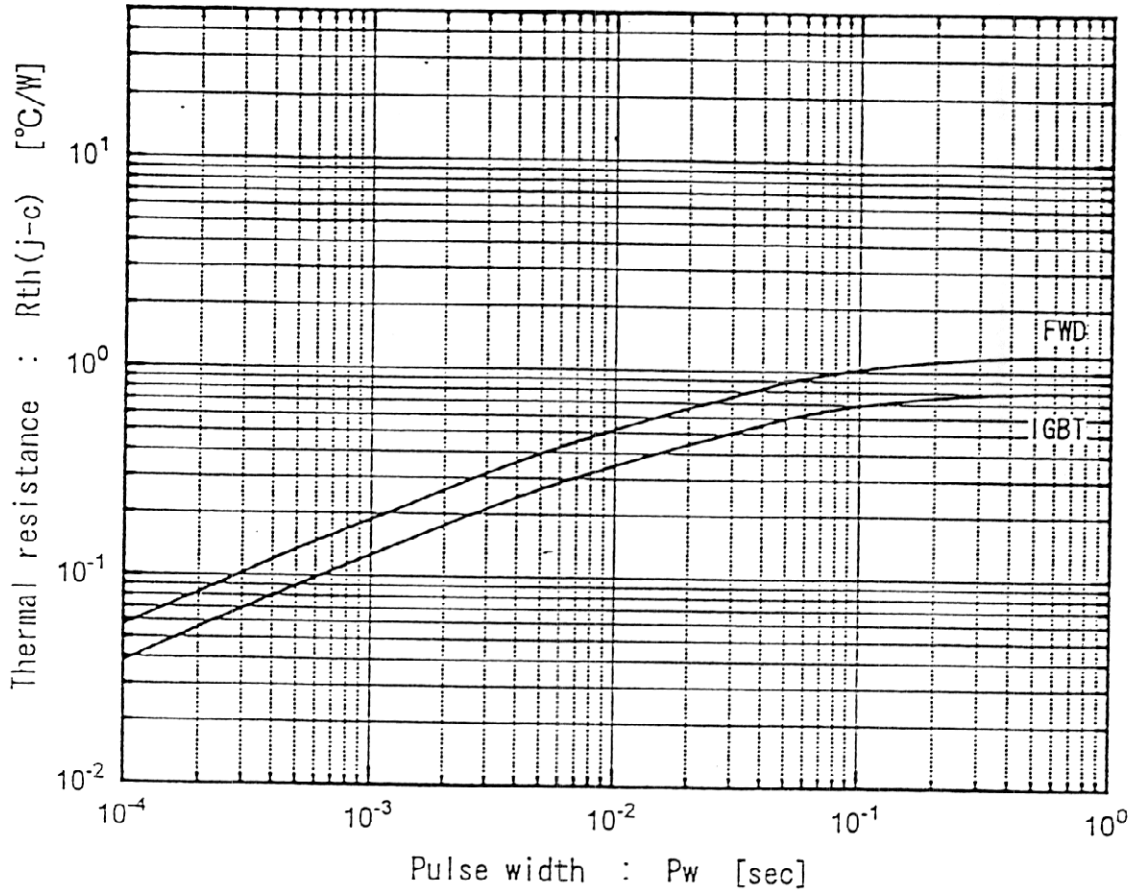

Fuji Electric Co., Ltd.

DWG. NO.

**MS5 F 4091**

14/14

H04-004-03