

1MBI150NK-060

IGBT Module

600V / 150A Chopper Module

■ Features

- High speed switching
- Low inductance module structure
- Suitable for Chopper circuit

■ Applications

- Uninterruptible power supply
- Inverter for Motor drive



■ Maximum ratings and characteristics

● Absolute maximum ratings (at Tc=25°C unless otherwise specified)

Item	Symbol	Rating	Unit		
IGBT	Collector-Emitter voltage	V _{CES}	600	V	
	Gate-Emitter voltage	V _{GES}	±20	V	
	Collector current	Continuous	I _C	150	A
		1 ms	I _C pulse	300	A
	Max. power dissipation	P _C	600	W	
FWD	Repetitive peak dissipation	V _{RRM}	600	V	
	Forward current	I _F	150	A	
		1 ms	I _F pulse	300	A
	Operating temperature	T _j	+150	°C	
Storage temperature	T _{stg}	-40 to +125	°C		
Isolation voltage	V _{is}	AC 2500 (1min.)	V		
Screw torque	Mounting *1	3.5	N·m		
	Terminals *1	3.5	N·m		

*1 : Recommendable value : 2.5 to 3.5 N·m (M5)

■ Equivalent Circuit Schematic

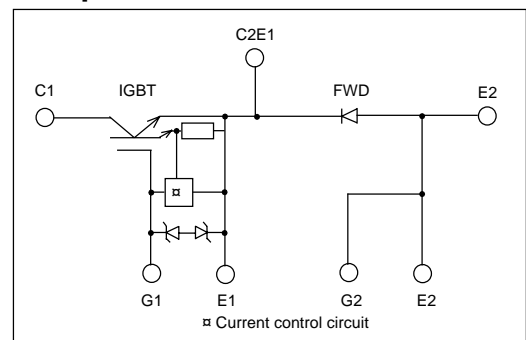

● Electrical characteristics (at Tj=25°C unless otherwise specified)

Item	Symbol	Characteristics			Conditions	Unit	
		Min.	Typ.	Max.			
IGBT	Zero gate voltage collector current	I _{CES}	–	–	1.0	V _{GE} =0V, V _{CES} =600V	mA
	Gate-Emitter leakage current	I _{GES}	–	–	15	V _{CE} =0V, V _{GE} =±20V	μA
	Gate-Emitter threshold voltage	V _{GE(th)}	4.5	–	7.5	V _{CE} =20V, I _C =150mA	V
	Collector-Emitter saturation voltage	V _{CE(sat)}	–	–	2.8	V _{GE} =15V, I _C =150A	V
	Input capacitance	C _{ies}	–	9900	–	V _{GE} =0V	pF
	Output capacitance	C _{oes}	–	2200	–	V _{CE} =10V	
	Reverse transfer capacitance	C _{res}	–	1000	–	f=1MHz	
	Turn-on time	t _{on}	–	0.6	1.2	V _{CC} =300V I _C =150A	μs
			–	0.2	0.6		
		Turn-off time	t _{off}	–	0.6	1.0	
t _f			–	0.2	0.35		
FWD	Diode forward on voltage	V _F	–	–	3.0	I _F =150A, V _{GE} =0V	V
	Reverse recovery time	t _{rr}	–	–	0.3	I _F =150A	μs
	Reverse current	I _{RRM}	–	–	1.0	V _R =600V	mA

● Thermal resistance characteristics

Item	Symbol	Characteristics			Conditions	Unit
		Min.	Typ.	Max.		
Thermal resistance	R _{th(j-c)}	–	–	0.21	IGBT	°C/W
	R _{th(j-c)}	–	–	0.47	FWD	°C/W
	R _{th(c-f)*2}	–	0.05	–	the base to cooling fin	°C/W

*2 : This is the value which is defined mounting on the additional cooling fin with thermal compound

■ Characteristics (Representative)

Collector current vs. Collector-Emitter voltage
T_J=25°C

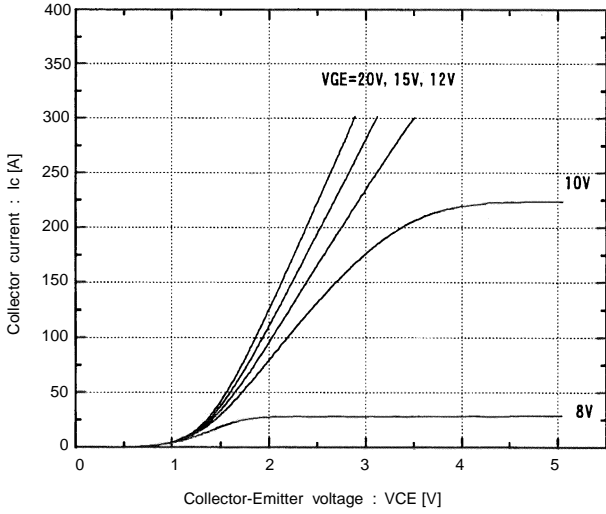

Collector current vs. Collector-Emitter voltage
T_J=125°C

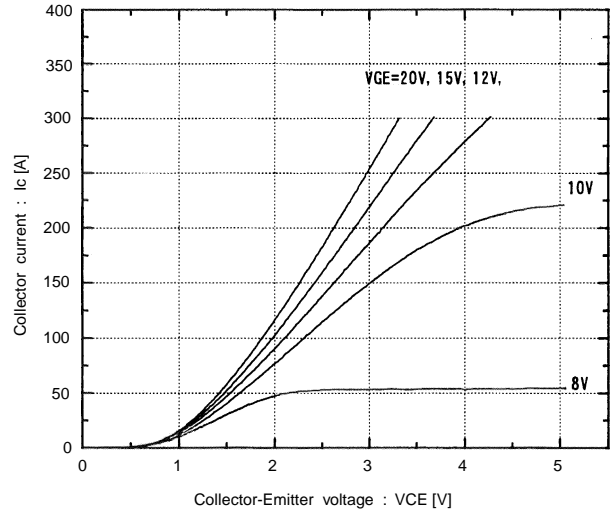

Collector-Emitter vs. Gate-Emitter voltage
T_J=25°C

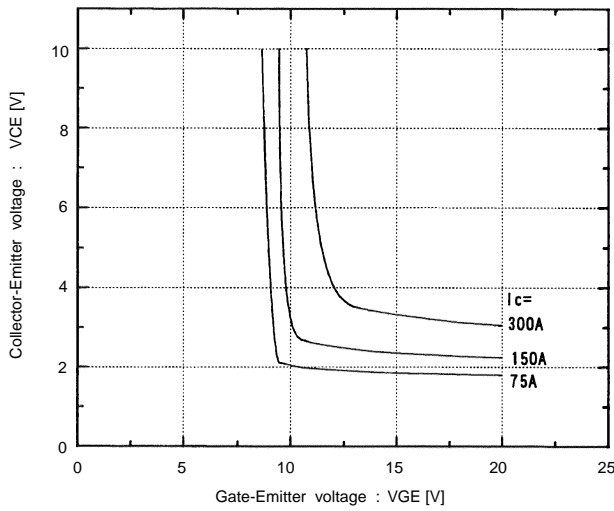

Collector-Emitter vs. Gate-Emitter voltage
T_J=125°C

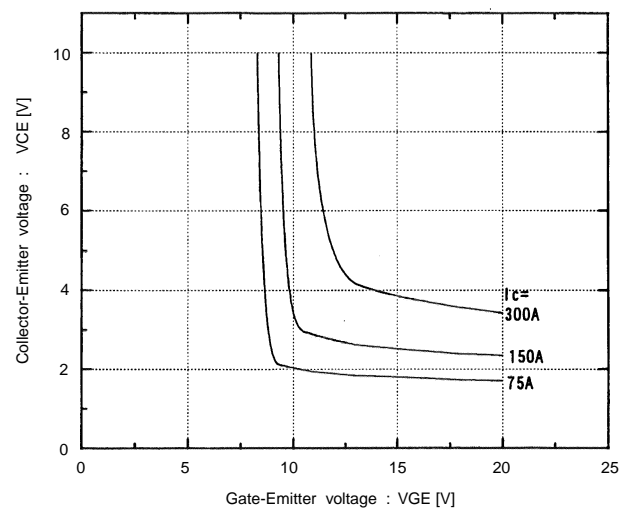

Switching time vs. Collector current
V_{CC}=300V, R_G=16 ohm, V_{GE}=±15V, T_J=25°C

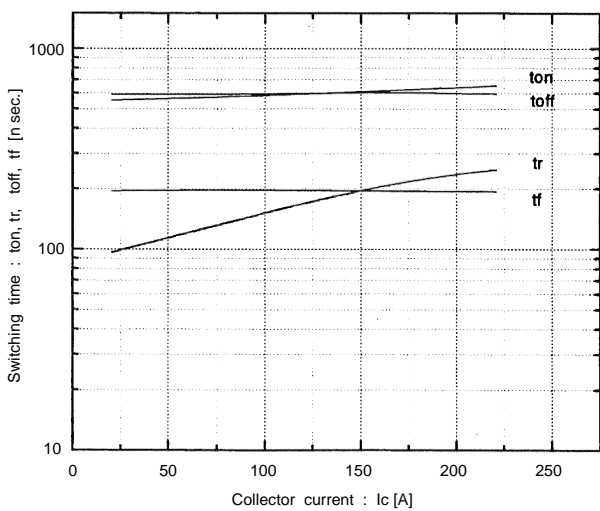

Switching time vs. Collector current
V_{CC}=300V, R_G=16 ohm, V_{GE}=±15V, T_J=125°C

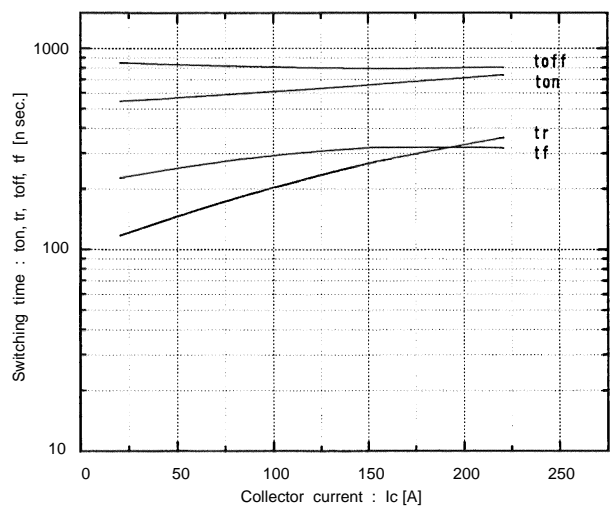

Switching time vs. RG
 $V_{cc}=300V, I_c=150A, V_{GE}=\pm 15V, T_j=25^\circ C$

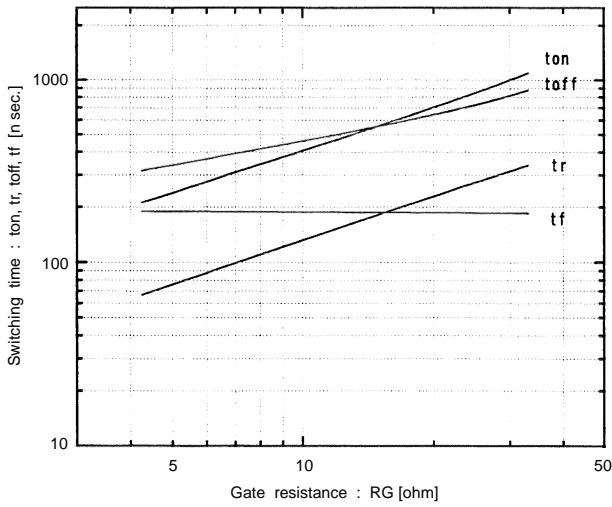

Dynamic input characteristics
 $T_j=25^\circ C$

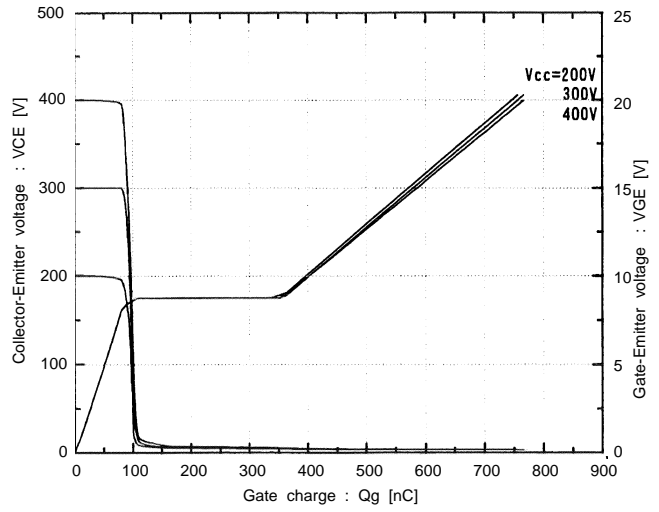

Forward current vs. Forward voltage
 $V_{GE}=0V$

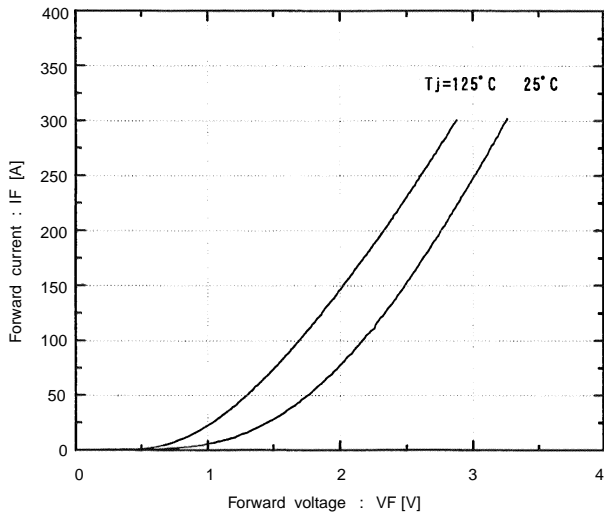

Reverse recovery characteristics
 t_{rr}, I_{rr} vs. I_F

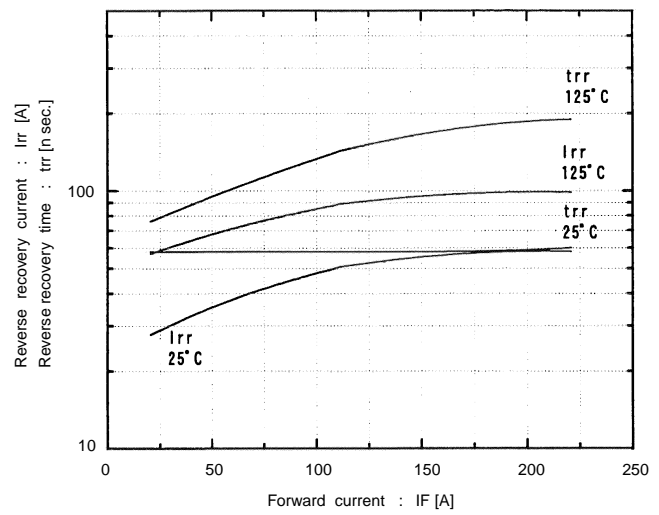

Transient thermal resistance

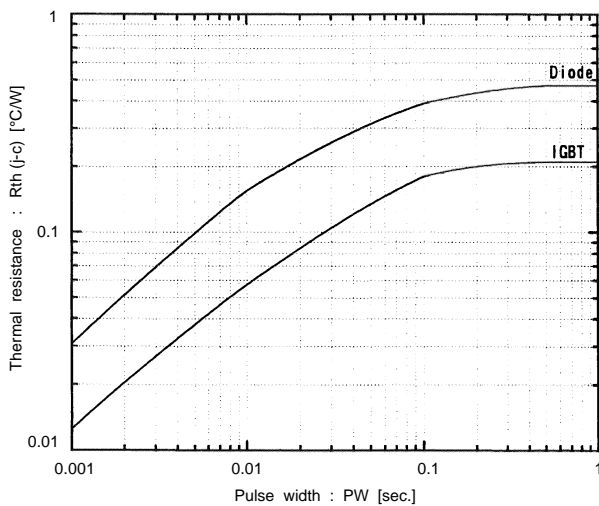

Reversed biased safe operating area
 $+V_{GE}=\pm 15V, -V_{GE} \le 15V, T_j \le 125^\circ C, R_G \ge 16 \text{ ohm}$

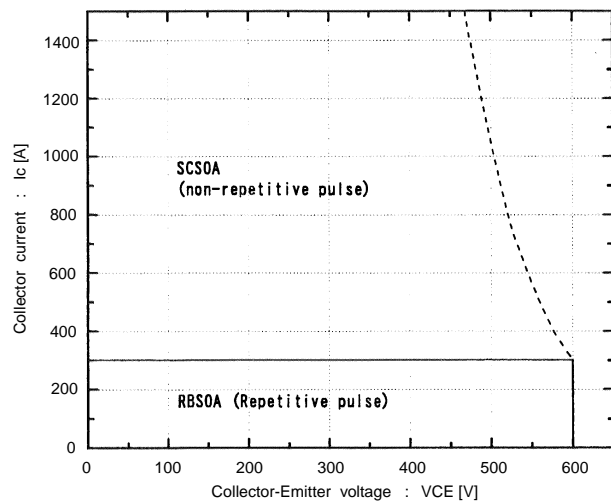

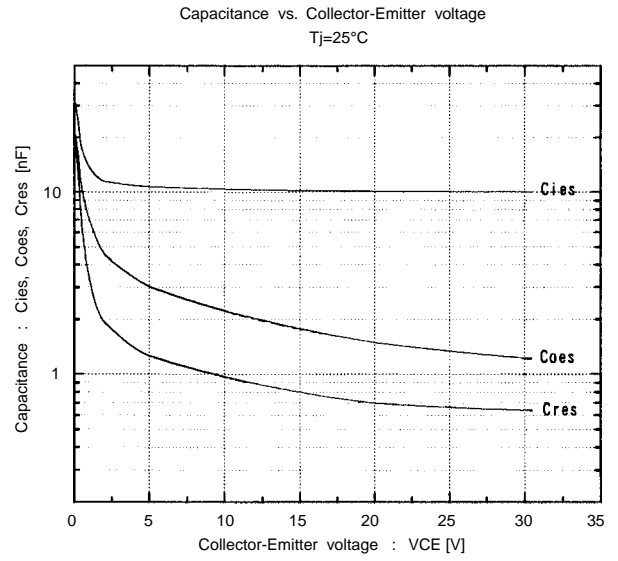
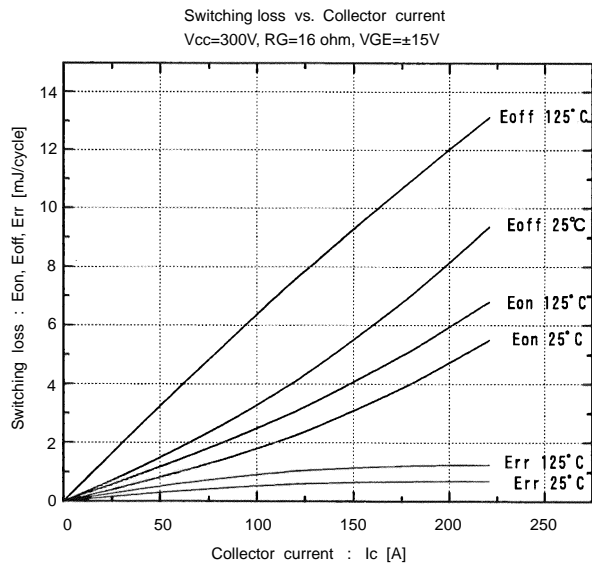

■ Outline Drawings, mm

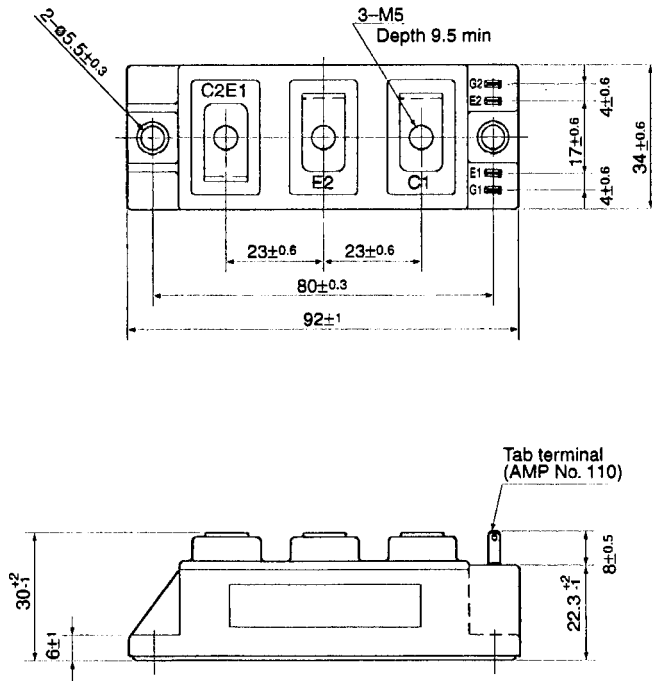

Mass : 180g