

### STANDARD RECOVERY DIODES

Stud Version

#### Features

- Diffused diode
- Wide current range
- High voltage ratings up to 1200V
- High surge current capabilities
- Stud cathode and stud anode version
- Hermetic metal case

320A

#### Typical Applications

- Welders
- Power supplies
- Machine tool controls
- High power drives
- Medium traction applications
- Battery charges
- Free-wheeling diodes

#### Major Ratings and Characteristics

Parameters	240U(R)..	Units
$I_{F(AV)}$	320	A
@ $T_C$	100	°C
$I_{F(RMS)}$	500	A
$I_{FSM}$ @ 50Hz	4500	A
@ 60Hz	4700	A
$I^2t$ @ 50Hz	101	KA <sup>2</sup> s
@ 60Hz	92	KA <sup>2</sup> s
$V_{RRM}$ range	600 to 1200	V
$T_J$	- 40 to 180	°C

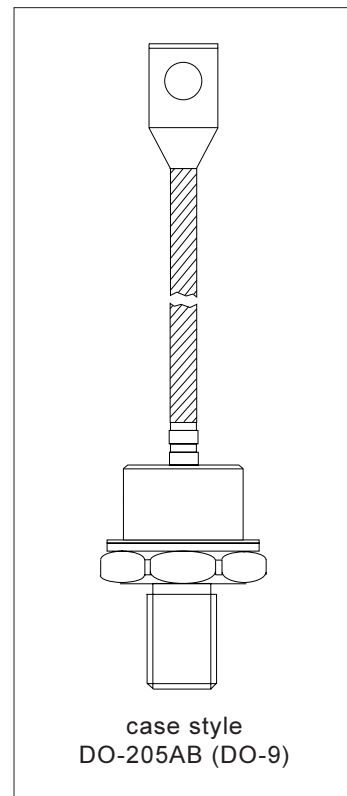

## 240U(R).. Series

Bulletin I2029 rev. D 09/03

International  
IR Rectifier

### ELECTRICAL SPECIFICATIONS

#### Voltage Ratings

Type number	Voltage Code	$V_{RRM}$ , maximum repetitive peak reverse voltage V	$V_{RSM}$ , maximum non-repetitive peak rev. voltage V	$I_{RRM}$ max. @ $T_J = T_J$ max. mA
240U(R)..	60	600	700	15
	80	800	900	
	100	1000	1100	
	120	1200	1300	

#### Forward Conduction

Parameter	240U(R)..	Units	Conditions
$I_{F(AV)}$ Max. average forward current @ Case temperature	320	A	180° conduction, half sine wave
	100	°C	
$I_{F(RMS)}$ Max. RMS forward current	500	A	DC @ 80°C case temperature
$I_{FSM}$ Max. peak, one-cycle forward, non-repetitive surge current	4500	A	t = 10ms No voltage
	4700		t = 8.3ms reapplied
	3800		t = 10ms 100% $V_{RRM}$
	4000		t = 8.3ms reapplied
$I^2t$ Maximum $I^2t$ for fusing	101	KA <sup>2</sup> s	t = 10ms No voltage
	92		t = 8.3ms reapplied
	72		t = 10ms 100% $V_{RRM}$
	66		t = 8.3ms reapplied
$I^2\sqrt{t}$ Maximum $I^2\sqrt{t}$ for fusing	1010	KA <sup>2</sup> √s	t = 0.1 to 10ms, no voltage reapplied
$r_f$ Slope resistance	0.6	mΩ	@ $T_J = T_J$ max.
$V_{F(T0)}$ Threshold voltage	0.83	V	
$V_{FM}$ Max. forward voltage drop	1.33	V	$I_{pk} = 750A$ , $T_J = 25^\circ C$ , $t_p = 10ms$ sinusoidal wave

#### Thermal and Mechanical Specifications

Parameter	240U(R)..	Units	Conditions
$T_J$ Max. junction operating temperature range	-40 to 180	°C	
$T_{stg}$ Max. storage temperature range	-40 to 180		
$R_{thJC}$ Max. thermal resistance, junction to case	0.18	K/W	DC operation
$R_{thCS}$ Max. thermal resistance, case to heatsink	0.08		Mounting surface, smooth, flat and greased
T Max. allowed mounting torque +0-20%	37 (330)	Nm (lb.in)	Not lubricated threads
	28 (250)		Lubricated threads
wt Approximate weight	250	g	
Case style	DO-205AB (DO-9)		See Outline Table

#### $\Delta R_{thJC}$ Conduction

(The following table shows the increment of thermal resistance  $R_{thJC}$  when devices operate at different conduction angles than DC)

Conduction angle	Sinusoidal conduction	Rectangular conduction	Units	Conditions
180°	0.019	0.015	K/W	$T_J = T_J$ max.
120°	0.023	0.025		
90°	0.030	0.034		
60°	0.045	0.047		
30°	0.076	0.076		

Ordering Information Table

<b>Device Code</b>					
<b>24</b>	<b>0</b>	<b>U</b>	<b>R</b>	<b>120</b>	<b>D</b>
1	2	3	4	5	6

<b>1</b>	-	24	=	Essential Part Number
<b>2</b>	-	0	=	Standard Device
<b>3</b>	-	U	=	Stud Normal Polarity (Cathode to Stud)
<b>4</b>	-	None	=	Stud Normal Polarity (Cathode to Stud)
		R	=	Stud Reverse Polarity (Anode to Stud)
<b>5</b>	-	Voltage code: Code x 10 = $V_{RRM}$ (See Voltage Ratings table)		
<b>6</b>	-	Diffused diode		

Note = For Metric Device M16 x 1.5 Contact Factory

Outline Table

**240U(R) Series**  
 Conforms to JEDEC DO-205AB (DO-9)  
 All dimensions in millimeters (inches)

\* FOR METRIC DEVICE: M16 X 1.5 CONTACT FACTORY  
 FOR DIFFERENT LEAD CONTACT FACTORY

## 240U(R).. Series

Bulletin I2029 rev. D 09/03

International  
**IR** Rectifier

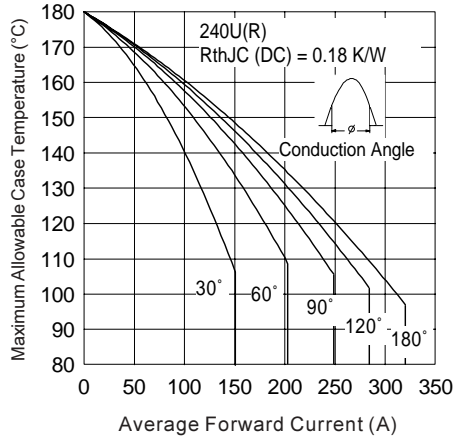

Fig. 1 - Current Ratings Characteristics

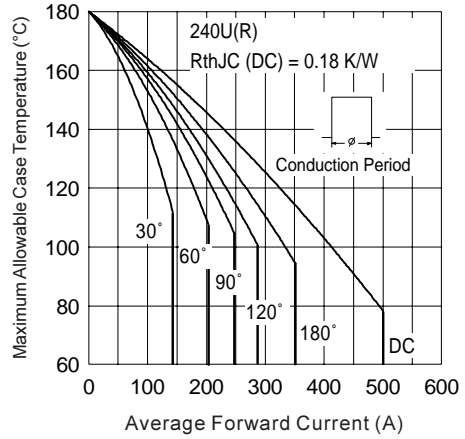

Fig. 2 - Current Ratings Characteristics

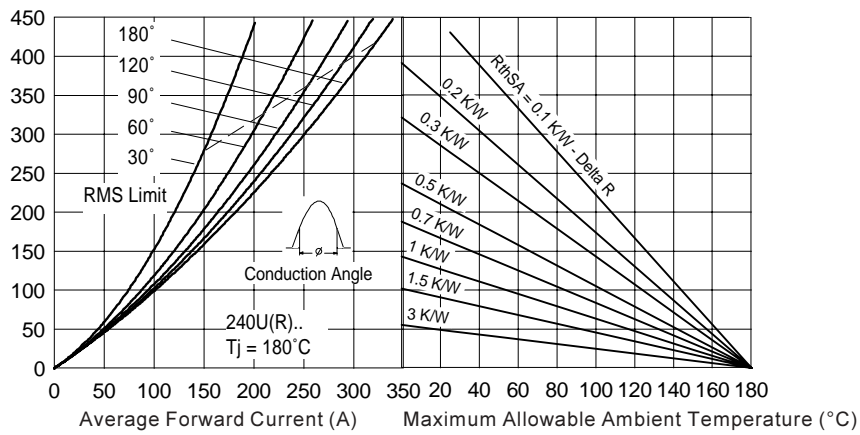

Fig. 3 - Forward Power Loss Characteristics

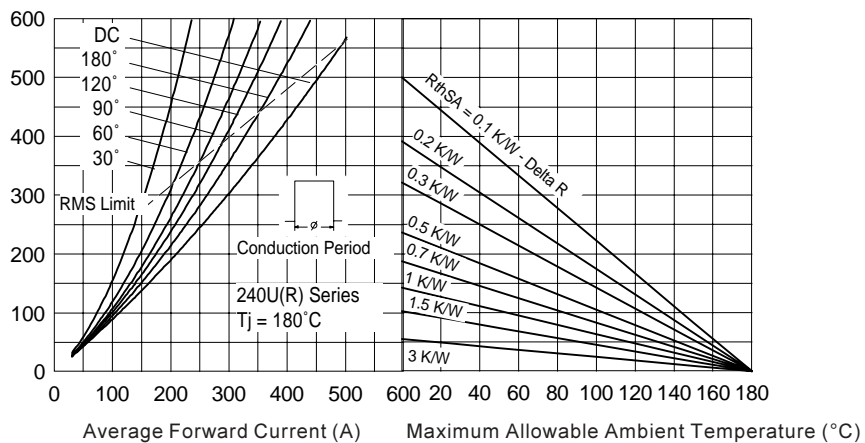

Fig. 4 - Forward Power Loss Characteristics

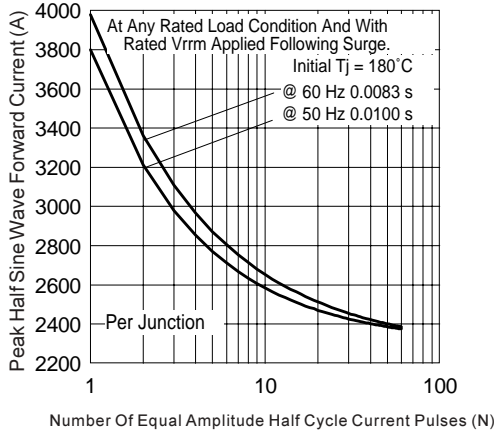

Fig. 5 - Maximum Non-Repetitive Surge Current

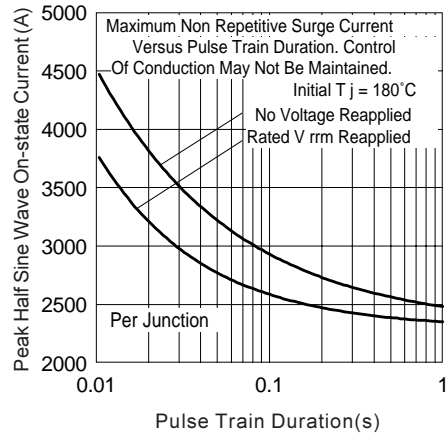

Fig. 6 - Maximum Non-Repetitive Surge Current

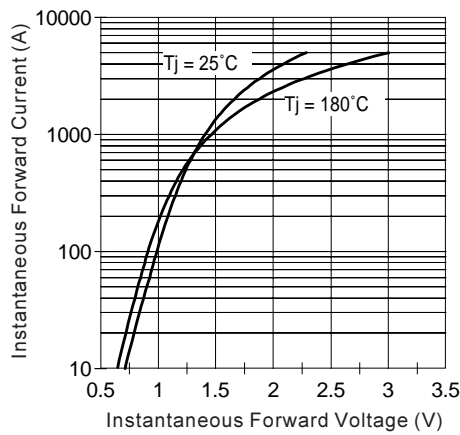

Fig. 7 - Forward Voltage Drop Characteristics

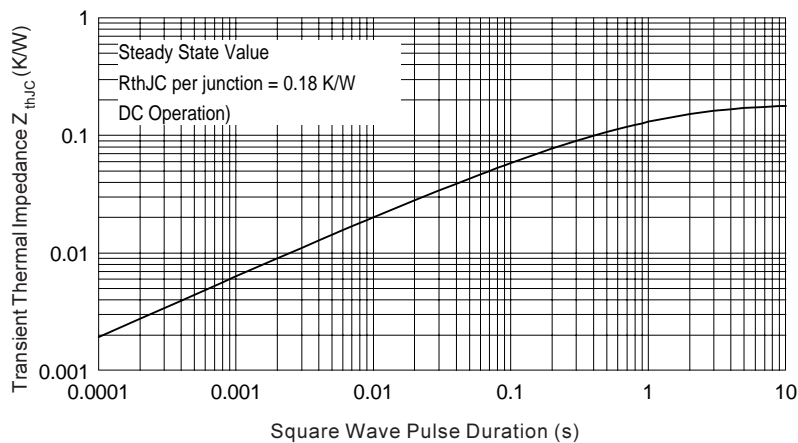

Fig. 8 - Thermal Impedance  $Z_{thJC}$  Characteristic

## 240U(R).. Series

Bulletin I2029 rev. D 09/03

International  
**IR** Rectifier

Data and specifications subject to change without notice.  
This product has been designed and qualified for Industrial Level.  
Qualification Standards can be found on IR's Web site.

International  
**IR** Rectifier

**IR WORLD HEADQUARTERS:** 233 Kansas St., El Segundo, California 90245, USA Tel: (310) 252-7105  
TAC Fax: (310) 252-7309

Visit us at [www.irf.com](http://www.irf.com) for sales contact information. 03/03