

Major Ratings and Characteristics

| Characteristics | 249NQ...(R) | Units |
|------------------------------------|-------------|------------|
| $I_{F(AV)}$ Rectangular waveform | 240 | A |
| V_{RRM} range | 135 to 150 | V |
| I_{FSM} @ $t_p = 5 \mu s$ sine | 20000 | A |
| V_F @240Apk, $T_J = 125^\circ C$ | 0.72 | V |
| T_J range | -55 to 175 | $^\circ C$ |

Description/ Features

The 249NQ...(R) high current Schottky rectifier module series has been optimized for low reverse leakage at high temperature. The proprietary barrier technology allows for reliable operation up to 175° C junction temperature. Typical applications are in switching power supplies, converters, free-wheeling diodes, and reverse battery protection.

- 175° C T_J operation
- Unique high power, Half-Pak module
- Replaces four parallel DO-5's
- Easier to mount and lower profile than DO-5's
- High purity, high temperature epoxy encapsulation for enhanced mechanical strength and moisture resistance
- Low forward voltage drop
- High frequency operation
- Guard ring for enhanced ruggedness and long term reliability

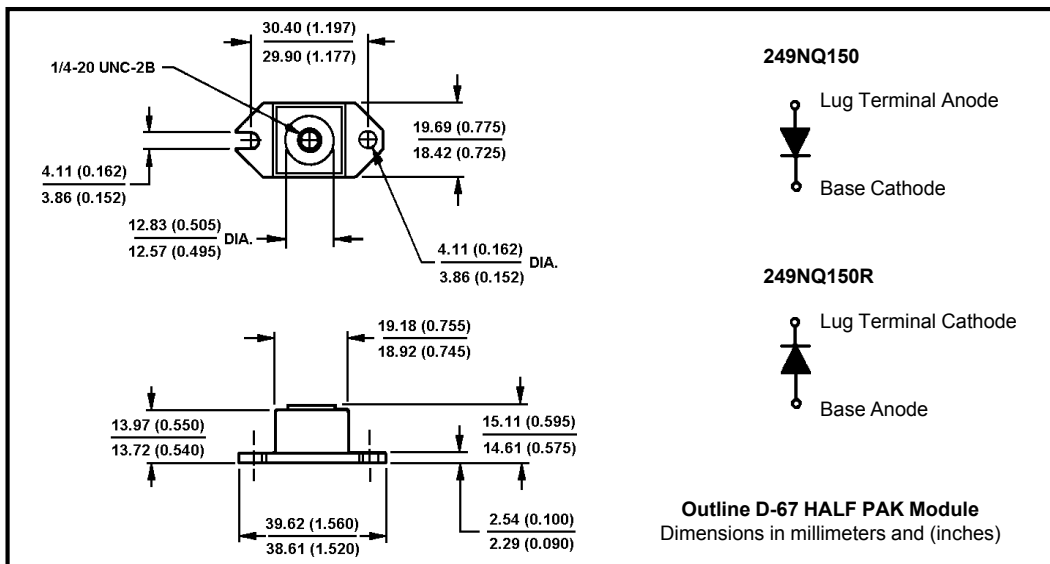

249NQ...(R) Series

Bulletin PD-20721 rev. A 06/02

International
IRF Rectifier

Voltage Ratings

| Part number | 249NQ135 | 249NQ150 |
|---|----------|----------|
| V_R Max. DC Reverse Voltage (V) | 135 | 150 |
| V_{RWM} Max. Working Peak Reverse Voltage (V) | | |

Absolute Maximum Ratings

| Parameters | 249NQ | Units | Conditions |
|---|-------|-------|--|
| $I_{F(AV)}$ Max. Average Forward Current * See Fig. 5 | 240 | A | 50% duty cycle @ $T_C = 117^\circ\text{C}$, rectangular wave form |
| I_{FSM} Max. Peak One Cycle Non-Repetitive Surge Current * See Fig. 7 | 20000 | A | 5 μs Sine or 3 μs Rect. pulse |
| | 2300 | | 10ms Sine or 6ms Rect. pulse |
| E_{AS} Non-Repetitive Avalanche Energy | 15 | mJ | $T_J = 25^\circ\text{C}$, $I_{AS} = 1\text{ Amps}$, $L = 30\text{ mH}$ |
| I_{AR} Repetitive Avalanche Current | 1 | A | Current decaying linearly to zero in 1 μsec Frequency limited by T_J max. $V_A = 1.5 \times V_R$ typical |

Electrical Specifications

| Parameters | 249NQ | Units | Conditions |
|---|-------|------------------|---|
| V_{FM} Max. Forward Voltage Drop (1) * See Fig. 1 | 1.07 | V | @ 240A |
| | 1.27 | V | @ 480A |
| | 0.74 | V | @ 240A |
| | 0.86 | V | @ 480A |
| I_{RM} Max. Reverse Leakage Current (1) * See Fig. 2 | 6 | mA | $T_J = 25^\circ\text{C}$ |
| | 85 | mA | $T_J = 125^\circ\text{C}$ |
| C_T Max. Junction Capacitance | 6000 | pF | $V_R = 5V_{DC}$, (test signal range 100Khz to 1Mhz) 25°C |
| L_S Typical Series Inductance | 5.0 | nH | From top of terminal hole to mounting plane |
| dv/dt Max. Voltage Rate of Change | 10000 | V/ μs | (Rated V_R) |

(1) Pulse Width < 300 μs , Duty Cycle < 2%

Thermal-Mechanical Specifications

| Parameters | 249NQ | Units | Conditions | |
|---|-----------------|---------------------------|--------------------------------------|---------|
| T_J Max. Junction Temperature Range | -55 to 175 | $^\circ\text{C}$ | | |
| T_{stg} Max. Storage Temperature Range | -55 to 175 | $^\circ\text{C}$ | | |
| R_{thJC} Max. Thermal Resistance Junction to Case | 0.20 | $^\circ\text{C}/\text{W}$ | DC operation * See Fig. 4 | |
| R_{thCS} Typical Thermal Resistance, Case to Heatsink | 0.15 | $^\circ\text{C}/\text{W}$ | Mounting surface, smooth and greased | |
| wt Approximate Weight | 25.6 (0.9) | g (oz.) | | |
| T Mounting Torque | Min. | 40 (35) | Non-lubricated threads | |
| | Max. | 58 (50) | | |
| | Terminal Torque | Min. | | 58 (50) |
| | | Max. | | 86 (75) |
| Case Style | HALF PAK Module | | | |

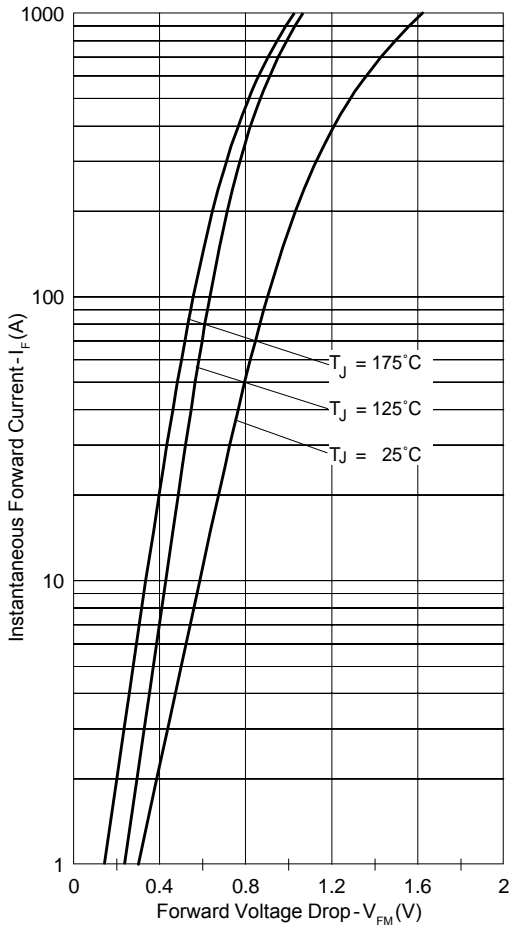

Fig. 1 - Max. Forward Voltage Drop Characteristics

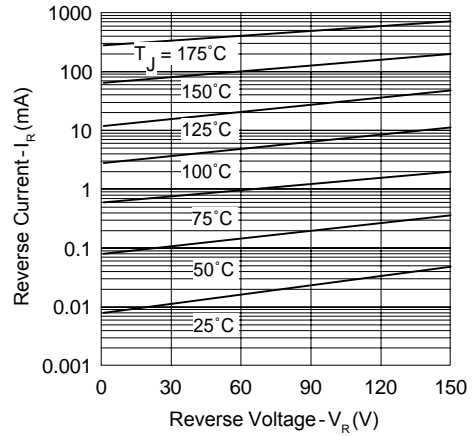

Fig. 2 - Typical Values Of Reverse Current Vs. Reverse Voltage

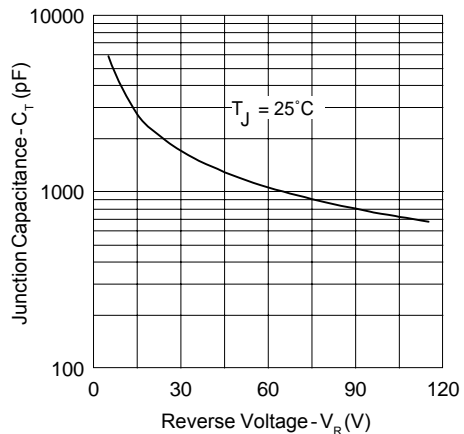

Fig. 3 - Typical Junction Capacitance Vs. Reverse Voltage

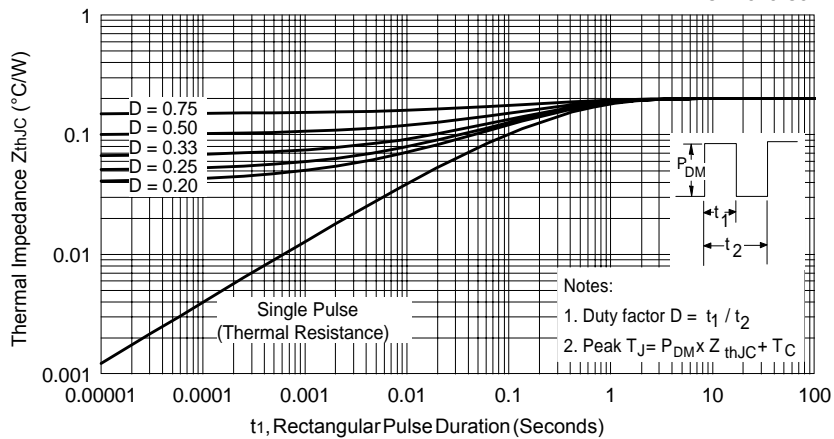

Fig. 4 - Max. Thermal Impedance Z_{thJC} Characteristics

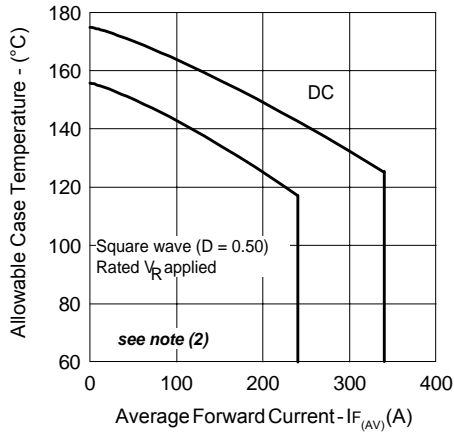

Fig. 5 - Max. Allowable Case Temperature Vs. Average Forward Current

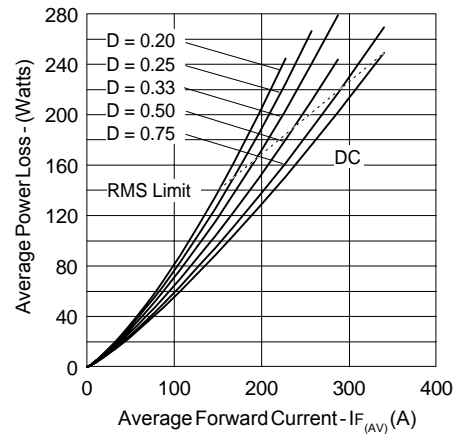

Fig. 6 - Forward Power Loss Characteristics

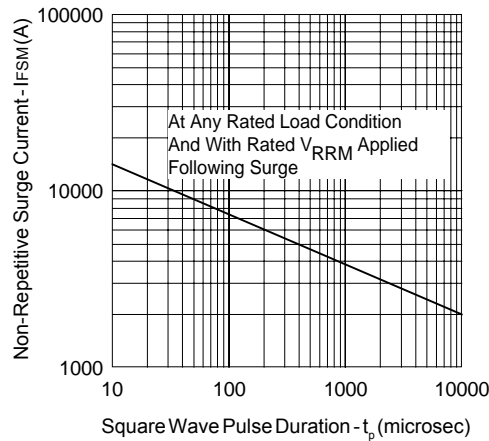

Fig. 7 - Max. Non-Repetitive Surge Current

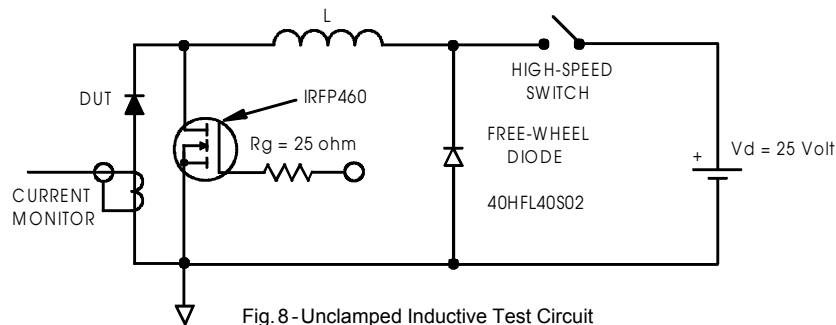

Fig. 8 - Unclamped Inductive Test Circuit

- (2) Formula used: $T_C = T_J - (P_d + P_{d_{REV}}) \times R_{INJC}$;
 $P_d = \text{Forward Power Loss} = I_{F(AV)} \times V_{FM} @ (I_{F(AV)} / D)$ (see Fig. 6);
 $P_{d_{REV}} = \text{Inverse Power Loss} = V_{R1} \times I_R (1 - D)$; $I_R @ V_{R1} = \text{rated } V_R$

Data and specifications subject to change without notice.
This product has been designed and qualified for Industrial Level.
Qualification Standards can be found on IR's Web site.

International
IOR Rectifier

IR WORLD HEADQUARTERS: 233 Kansas St., El Segundo, California 90245, USA Tel: (310) 252-7105
TAC Fax: (310) 252-7309
Visit us at www.irf.com for sales contact information. 06/02