

Major Ratings and Characteristics

Characteristics	249NQ...(R)	Units
$I_{F(AV)}$ Rectangular waveform	240	A
V_{RRM} range	135 to 150	V
I_{FSM} @ $t_p = 5 \mu s$ sine	20000	A
V_F @240Apk, $T_J = 125^\circ C$	0.72	V
T_J range	-55 to 175	$^\circ C$

Description/ Features

The 249NQ...(R) high current Schottky rectifier module series has been optimized for low reverse leakage at high temperature. The proprietary barrier technology allows for reliable operation up to 175° C junction temperature. Typical applications are in switching power supplies, converters, free-wheeling diodes, and reverse battery protection.

- 175° C T_J operation
- Unique high power, Half-Pak module
- Replaces four parallel DO-5's
- Easier to mount and lower profile than DO-5's
- High purity, high temperature epoxy encapsulation for enhanced mechanical strength and moisture resistance
- Low forward voltage drop
- High frequency operation
- Guard ring for enhanced ruggedness and long term reliability

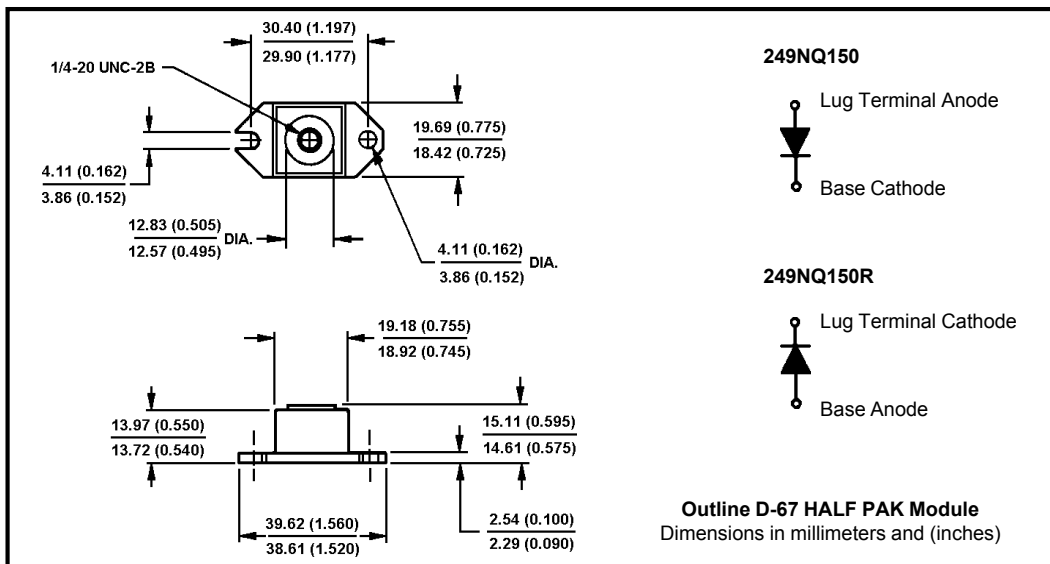

249NQ...(R) Series

Bulletin PD-20721 rev. A 06/02

International
IRF Rectifier

Voltage Ratings

Part number	249NQ135	249NQ150
V_R Max. DC Reverse Voltage (V)	135	150
V_{RWM} Max. Working Peak Reverse Voltage (V)		

Absolute Maximum Ratings

Parameters	249NQ	Units	Conditions
$I_{F(AV)}$ Max. Average Forward Current * See Fig. 5	240	A	50% duty cycle @ $T_C = 117^\circ\text{C}$, rectangular wave form
I_{FSM} Max. Peak One Cycle Non-Repetitive Surge Current * See Fig. 7	20000	A	5 μs Sine or 3 μs Rect. pulse
	2300		10ms Sine or 6ms Rect. pulse
E_{AS} Non-Repetitive Avalanche Energy	15	mJ	$T_J = 25^\circ\text{C}$, $I_{AS} = 1\text{ Amps}$, $L = 30\text{ mH}$
I_{AR} Repetitive Avalanche Current	1	A	Current decaying linearly to zero in 1 μsec Frequency limited by T_J max. $V_A = 1.5 \times V_R$ typical

Electrical Specifications

Parameters	249NQ	Units	Conditions
V_{FM} Max. Forward Voltage Drop (1) * See Fig. 1	1.07	V	@ 240A
	1.27	V	@ 480A
	0.74	V	@ 240A
	0.86	V	@ 480A
I_{RM} Max. Reverse Leakage Current (1) * See Fig. 2	6	mA	$T_J = 25^\circ\text{C}$
	85	mA	$T_J = 125^\circ\text{C}$
C_T Max. Junction Capacitance	6000	pF	$V_R = 5V_{DC}$, (test signal range 100Khz to 1Mhz) 25°C
L_S Typical Series Inductance	5.0	nH	From top of terminal hole to mounting plane
dv/dt Max. Voltage Rate of Change	10000	V/ μs	(Rated V_R)

(1) Pulse Width < 300 μs , Duty Cycle < 2%

Thermal-Mechanical Specifications

Parameters	249NQ	Units	Conditions	
T_J Max. Junction Temperature Range	-55 to 175	$^\circ\text{C}$		
T_{stg} Max. Storage Temperature Range	-55 to 175	$^\circ\text{C}$		
R_{thJC} Max. Thermal Resistance Junction to Case	0.20	$^\circ\text{C}/\text{W}$	DC operation * See Fig. 4	
R_{thCS} Typical Thermal Resistance, Case to Heatsink	0.15	$^\circ\text{C}/\text{W}$	Mounting surface, smooth and greased	
wt Approximate Weight	25.6 (0.9)	g (oz.)		
T Mounting Torque	Min.	40 (35)	Non-lubricated threads	
	Max.	58 (50)		
	Terminal Torque	Min.		58 (50)
		Max.		86 (75)
Case Style	HALF PAK Module			

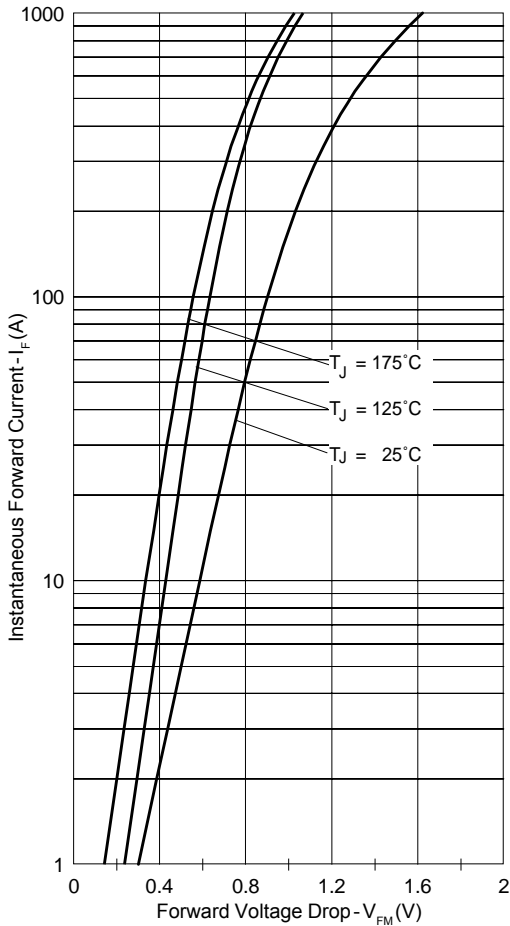

Fig. 1 - Max. Forward Voltage Drop Characteristics

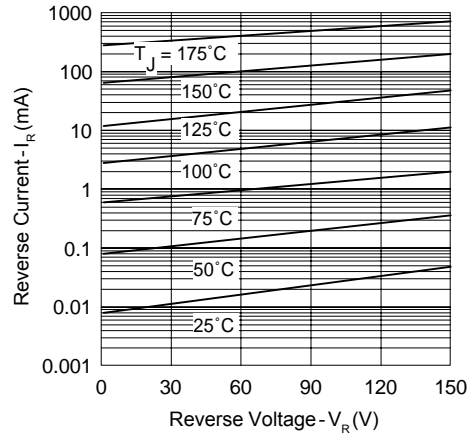

Fig. 2 - Typical Values Of Reverse Current Vs. Reverse Voltage

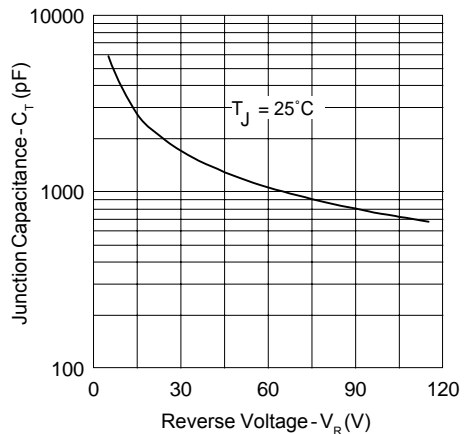

Fig. 3 - Typical Junction Capacitance Vs. Reverse Voltage

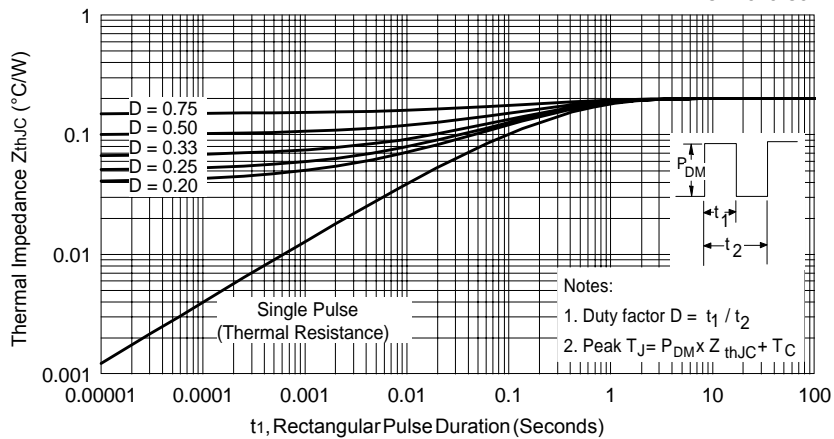

Fig. 4 - Max. Thermal Impedance Z_{thJC} Characteristics

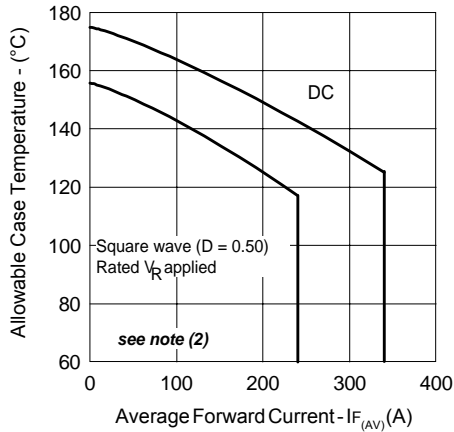

Fig. 5 - Max. Allowable Case Temperature Vs. Average Forward Current

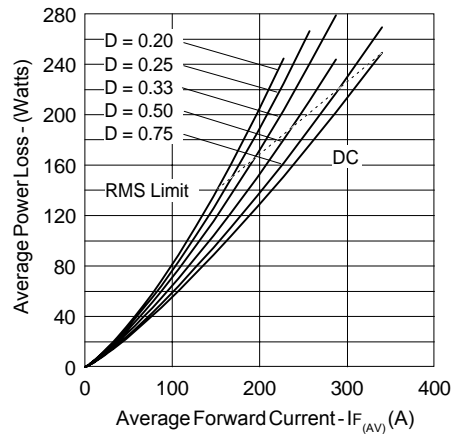

Fig. 6 - Forward Power Loss Characteristics

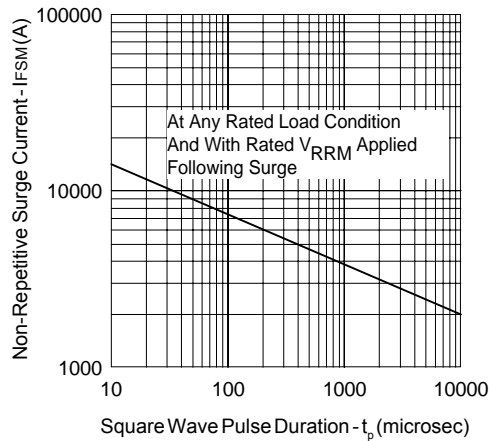

Fig. 7 - Max. Non-Repetitive Surge Current

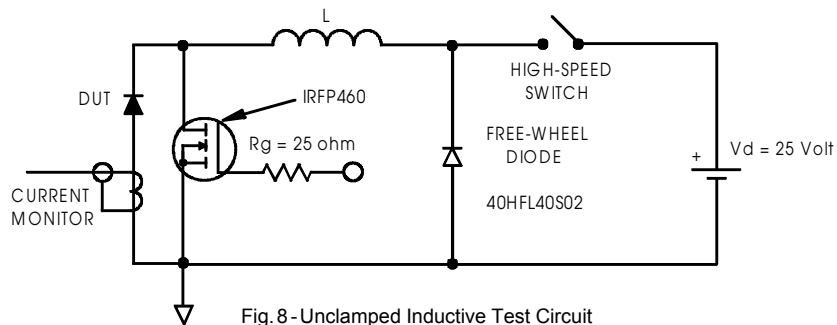

Fig. 8 - Unclamped Inductive Test Circuit

- (2) Formula used: $T_C = T_J - (P_d + P_{d_{REV}}) \times R_{INJC}$;
 $P_d = \text{Forward Power Loss} = I_{F(AV)} \times V_{FM} @ (I_{F(AV)} / D)$ (see Fig. 6);
 $P_{d_{REV}} = \text{Inverse Power Loss} = V_{R1} \times I_R (1 - D)$; $I_R @ V_{R1} = \text{rated } V_R$

Data and specifications subject to change without notice.
This product has been designed and qualified for Industrial Level.
Qualification Standards can be found on IR's Web site.

International
IOR Rectifier

IR WORLD HEADQUARTERS: 233 Kansas St., El Segundo, California 90245, USA Tel: (310) 252-7105
TAC Fax: (310) 252-7309
Visit us at www.irf.com for sales contact information. 06/02