

# 2MBI200NB-120-01

IGBT Module

## 1200V / 200A 2 in one-package

### ■ Features

- VCE(sat) classified for easy parallel connection
- High speed switching
- Voltage drive
- Low inductance module structure

### ■ Applications

- Inverter for Motor drive
- AC and DC Servo drive amplifier
- Uninterruptible power supply
- Industrial machines, such as Welding machines

### ■ Maximum ratings and characteristics

#### ● Absolute maximum ratings (at Tc=25°C unless otherwise specified)

Item	Symbol	Rating	Unit
Collector-Emitter voltage	V <sub>CES</sub>	1200	V
Gate-Emitter voltage	V <sub>GES</sub>	±20	V
Collector current	Continuous	I <sub>c</sub>	200
	1ms	I <sub>c</sub> pulse	400
		-I <sub>c</sub>	200
	1ms	-I <sub>c</sub> pulse	400
Max. power dissipation	P <sub>c</sub>	1500	W
Operating temperature	T <sub>j</sub>	+150	°C
Storage temperature	T <sub>stg</sub>	-40 to +125	°C
Isolation voltage	V <sub>is</sub>	AC 2500 (1min.)	V
Screw torque	Mounting * <sub>1</sub>	3.5	N·m
	Terminals * <sub>2</sub>	4.5	N·m

\*<sub>1</sub> : Recommendable value : 2.5 to 3.5 N·m (M5) or (M6)

\*<sub>2</sub> : Recommendable value : 3.5 to 4.5 N·m (M6)

#### ● Electrical characteristics (at T<sub>j</sub>=25°C unless otherwise specified)

Item	Symbol	Characteristics			Conditions	Unit
		Min.	Typ.	Max.		
Zero gate voltage collector current	I <sub>CES</sub>	-	-	2.0	V <sub>GE</sub> =0V, V <sub>CE</sub> =1200V	mA
Gate-Emitter leakage current	I <sub>GES</sub>	-	-	30	V <sub>CE</sub> =0V, V <sub>GE</sub> =±20V	µA
Gate-Emitter threshold voltage	V <sub>GE(th)</sub>	4.5	-	7.5	V <sub>CE</sub> =20V, I <sub>c</sub> =200mA	V
Collector-Emitter saturation voltage	V <sub>CE(sat)</sub>	-	-	3.3	V <sub>GE</sub> =15V, I <sub>c</sub> =200A	V
Input capacitance	C <sub>ies</sub>	-	32000	-	V <sub>GE</sub> =0V	pF
Output capacitance	C <sub>oes</sub>	-	11600	-	V <sub>CE</sub> =10V	
Reverse transfer capacitance	C <sub>res</sub>	-	10320	-	f=1MHz	
Turn-on time	t <sub>on</sub>	-	0.65	1.2	V <sub>CC</sub> =600V	µs
	t <sub>r</sub>	-	0.25	0.6	I <sub>c</sub> =200A	
Turn-off time	t <sub>off</sub>	-	0.85	1.5	V <sub>GE</sub> =±15V	
	t <sub>f</sub>	-	0.35	0.5	R <sub>G</sub> =4.7ohm	
Diode forward on voltage	V <sub>F</sub>	-	-	3.0	I <sub>F</sub> =200A, V <sub>GE</sub> =0V	V
Reverse recovery time	t <sub>rr</sub>	-	-	0.35	I <sub>F</sub> =200A	µs

#### ● Thermal resistance characteristics

Item	Symbol	Characteristics			Conditions	Unit
		Min.	Typ.	Max.		
Thermal resistance	R <sub>th(j-c)</sub>	-	-	0.085	IGBT	°C/W
	R <sub>th(j-c)</sub>	-	-	0.18	Diode	°C/W
	R <sub>th(c-f)*</sub>	-	0.025	-	the base to cooling fin	°C/W

\* : This is the value which is defined mounting on the additional cooling fin with thermal compound



### ■ Equivalent Circuit Schematic

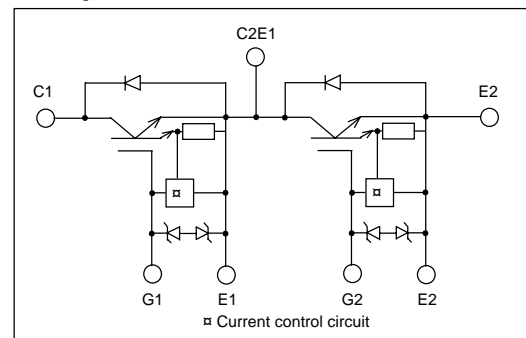

#### ● VCE(sat) classification

Rank	Lenge	Conditions
F	2.25 to 2.50V	I <sub>c</sub> = 200A V <sub>GE</sub> = 15V T <sub>j</sub> = 25°C
A	2.40 to 2.65V	
B	2.55 to 2.80V	
C	2.70 to 2.95V	
D	2.85 to 3.10V	
E	3.00 to 3.30V	

■ Characteristics (Representative)

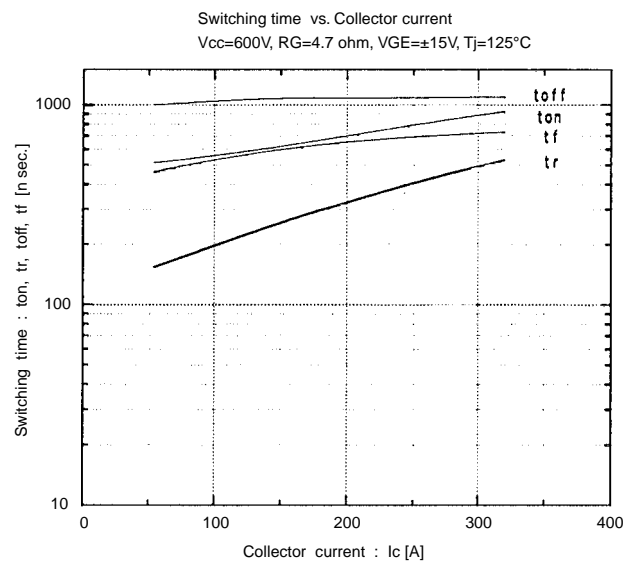
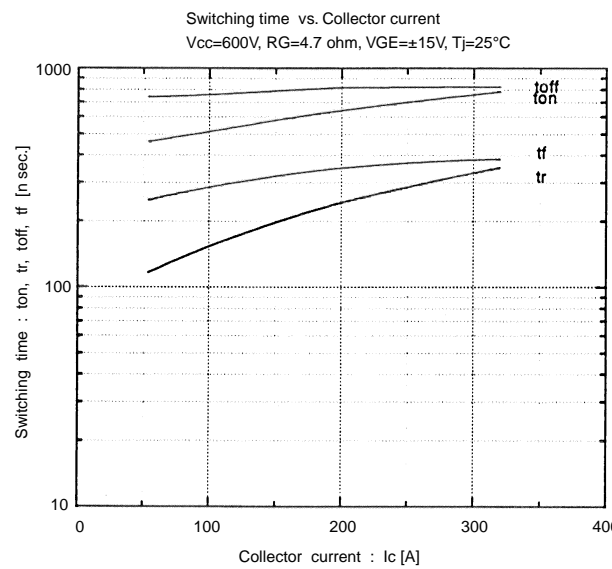
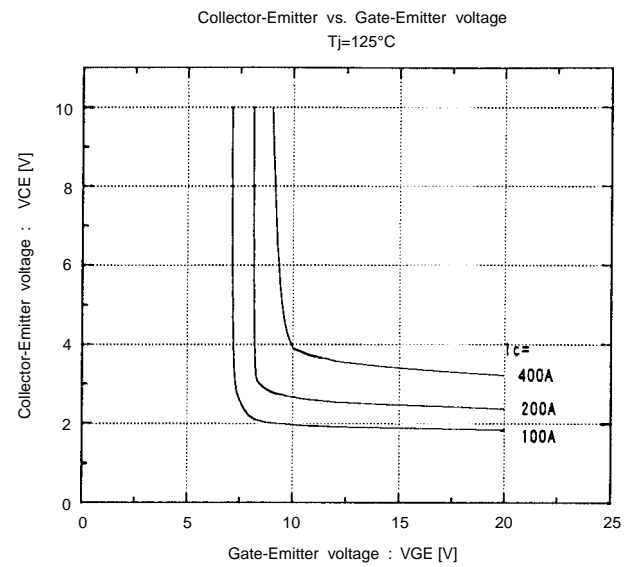
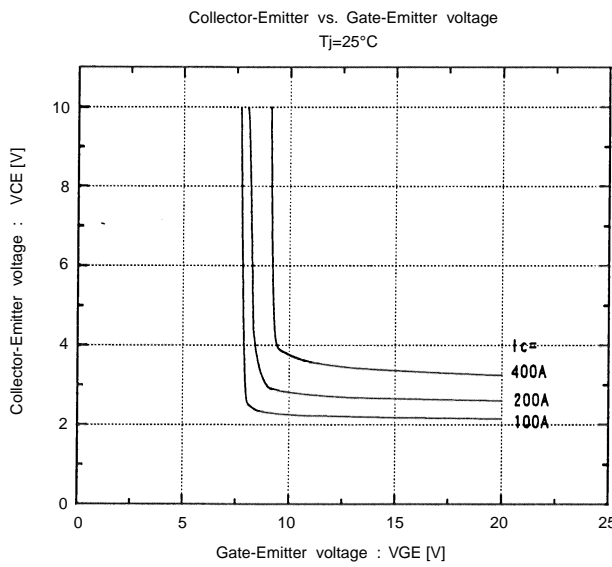
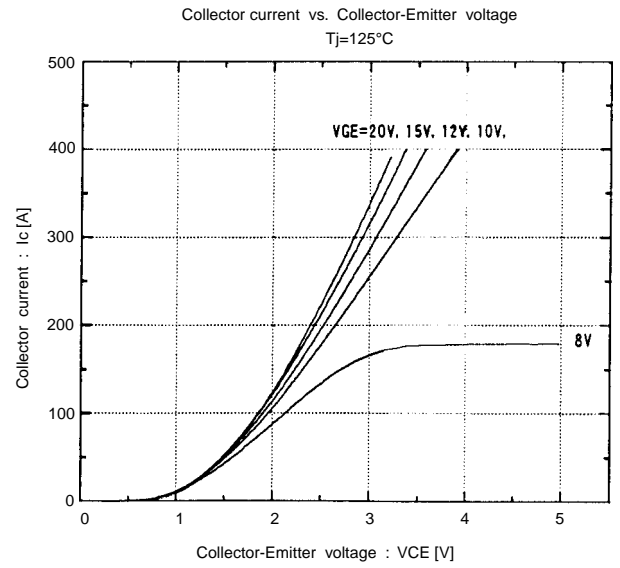
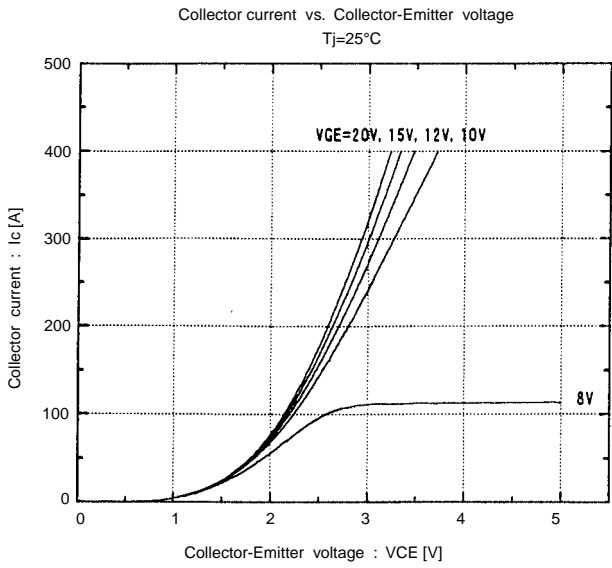

Switching time vs.  $R_G$   
 $V_{CC}=600V, I_c=200A, V_{GE}=\pm 15V, T_J=25^\circ C$

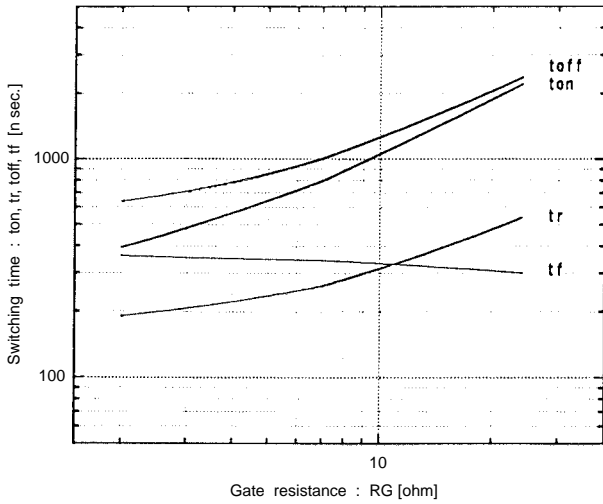

Dynamic input characteristics  
 $T_J=25^\circ C$

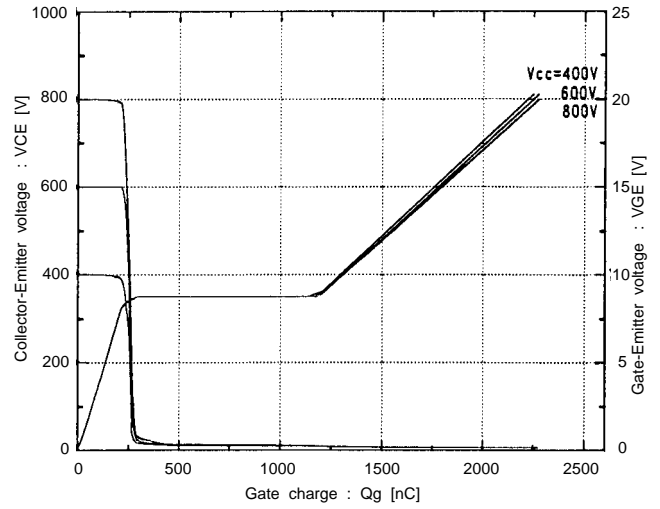

Forward current vs. Forward voltage  
 $V_{GE}=0V$

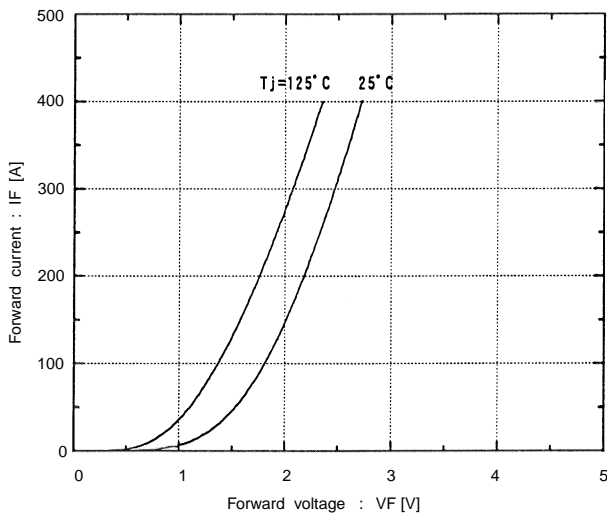

Reverse recovery characteristics  
 $t_{rr}, I_{rr}$ , vs.  $I_F$

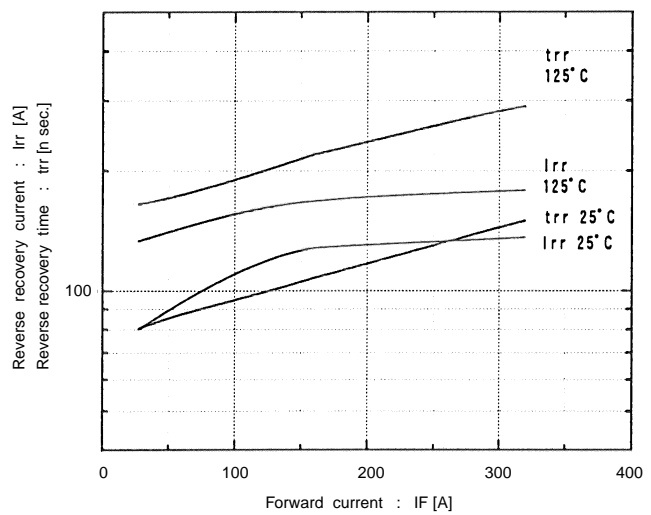

Transient thermal resistance

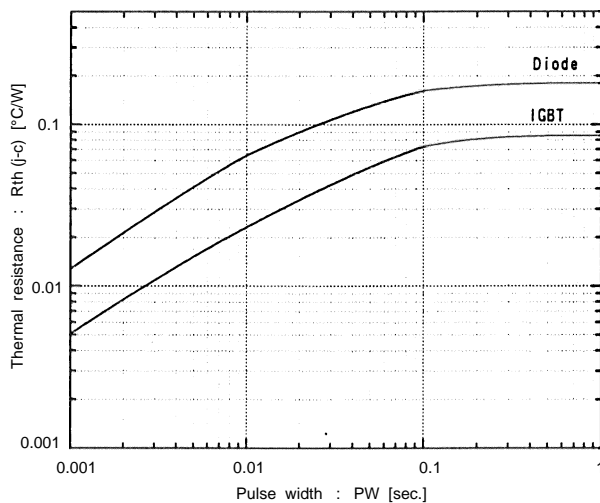

Reversed biased safe operating area  
 $+V_{GE}=15V, -V_{GE} \le 15V, T_J \le 125^\circ C, R_G \ge 4.7ohm$

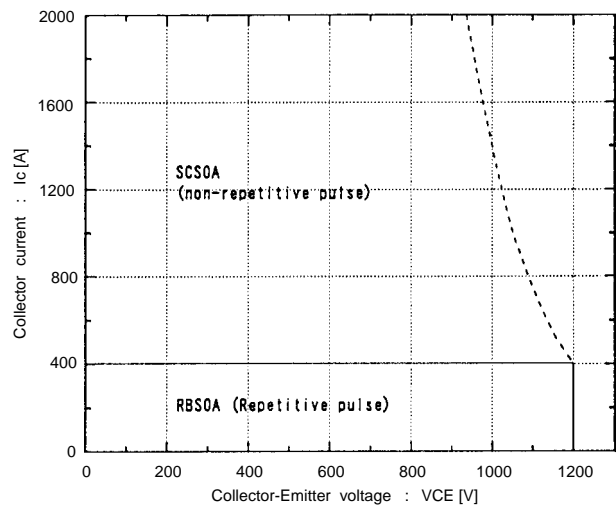

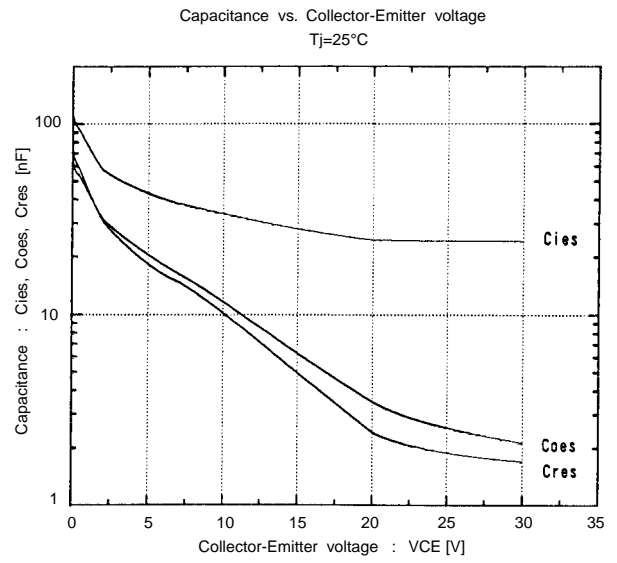
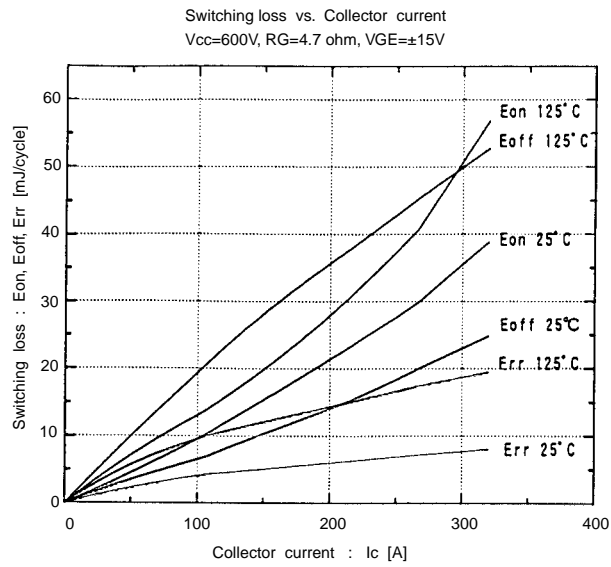

■ Outline Drawings, mm

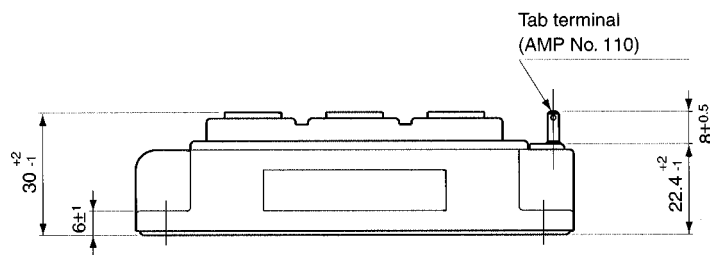
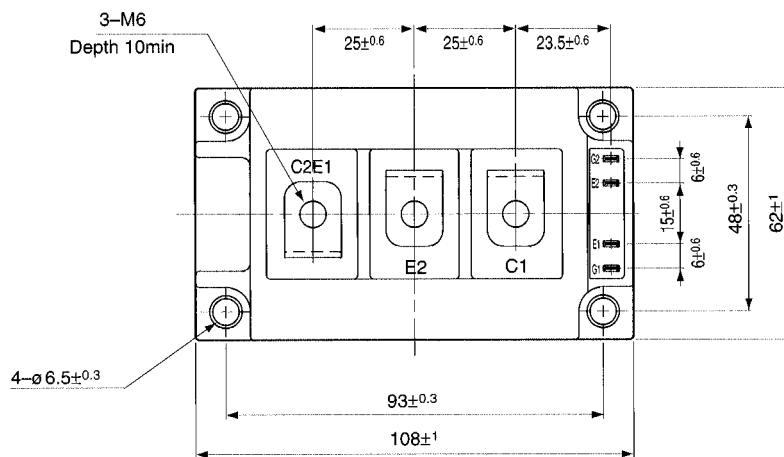

Mass : 370g