

## N-CHANNEL SILICON POWER MOSFET

## FAP-IIA SERIES

### ■ Features

- High speed switching
- Low on-resistance
- No secondary breakdown
- Low driving power
- High voltage
- $V_{GS}=\pm 30V$  Guarantee
- Avalanche-proof

### ■ Applications

- Switching regulators
- UPS
- DC-DC converters
- General purpose power amplifier

### ■ Maximum ratings and characteristics

#### ● Absolute maximum ratings ( $T_c=25^\circ C$ unless otherwise specified)

Item	Symbol	Rating	Unit
Drain-source voltage	$V_{DS}$	900	V
Continuous drain current	$I_D$	5	A
Pulsed drain current	$I_{D(puls)}$	20	A
Continuous reverse drain current	$I_{DR}$	5	A
Gate-source peak voltage	$V_{GS}$	$\pm 30$	V
Max. power dissipation	$P_D$	80	W
Operating and storage temperature range	$T_{ch}$	+150	$^\circ C$
	$T_{stg}$	-55 to +150	$^\circ C$

#### ● Electrical characteristics ( $T_c = 25^\circ C$ unless otherwise specified)

Item	Symbol	Test Conditions	Min.	Typ.	Max.	Units
Drain-source breakdown voltage	$V_{(BR)DSS}$	$I_D=1mA$ $V_{GS}=0V$	900			V
Gate threshold voltage	$V_{GS(th)}$	$I_D=1mA$ $V_{DS}=V_{GS}$	2.5	3.0	3.5	V
Zero gate voltage drain current	$I_{DSS}$	$V_{DS}=900V$ $V_{GS}=0V$	$T_{ch}=25^\circ C$	10	500	$\mu A$
			$T_{ch}=125^\circ C$	0.2	1.0	mA
Gate-source leakage current	$I_{GSS}$	$V_{GS}=\pm 30V$ $V_{DS}=0V$		10	100	nA
Drain-source on-state resistance	$R_{DS(on)}$	$I_D=2.5A$ $V_{GS}=10V$		2.0	2.8	$\Omega$
Forward transconductance	$g_{fs}$	$I_D=2.5A$ $V_{DS}=25V$	3.0	6.0		S
Input capacitance	$C_{iss}$	$V_{DS}=25V$		1200	1800	pF
Output capacitance	$C_{oss}$	$V_{GS}=0V$		120	180	
Reverse transfer capacitance	$C_{rss}$	$f=1MHz$		40	60	
Turn-on time $t_{on}$ ( $t_{on}=t_{d(on)}+t_r$ )	$t_{d(on)}$	$V_{CC}=600V$ $R_G=10\Omega$		25	40	ns
	$t_r$	$I_D=5A$		25	40	
Turn-off time $t_{off}$ ( $t_{off}=t_{d(off)}+t_f$ )	$t_{d(off)}$	$V_{GS}=10V$		85	130	
	$t_f$			45	70	
Avalanche capability	$I_{AV}$	$L=100\mu H$ $T_{ch}=25^\circ C$	5			A
Diode forward on-voltage	$V_{SD}$	$I_F=2I_{DR}$ $V_{GS}=0V$ $T_{ch}=25^\circ C$		0.93	1.4	V
Reverse recovery time	$t_{rr}$	$I_F=I_{DR}$ $V_{GS}=0V$ $di/dt=100A/\mu s$ $T_{ch}=25^\circ C$		400		ns

#### ● Thermal characteristics

Item	Symbol	Test Conditions	Min.	Typ.	Max.	Units
Thermal resistance	$R_{th(ch-a)}$	channel to ambient			75.0	$^\circ C/W$
	$R_{th(ch-c)}$	channel to case			1.56	$^\circ C/W$

### ■ Outline Drawings

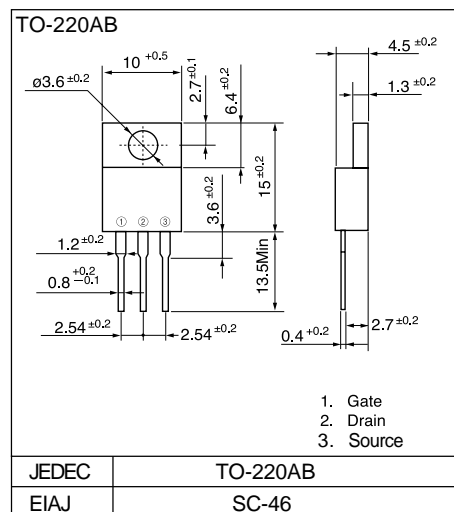

### ■ Equivalent circuit schematic

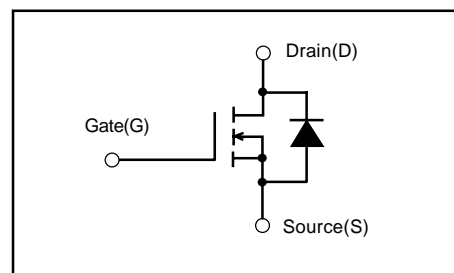

Characteristics

Typical output characteristics

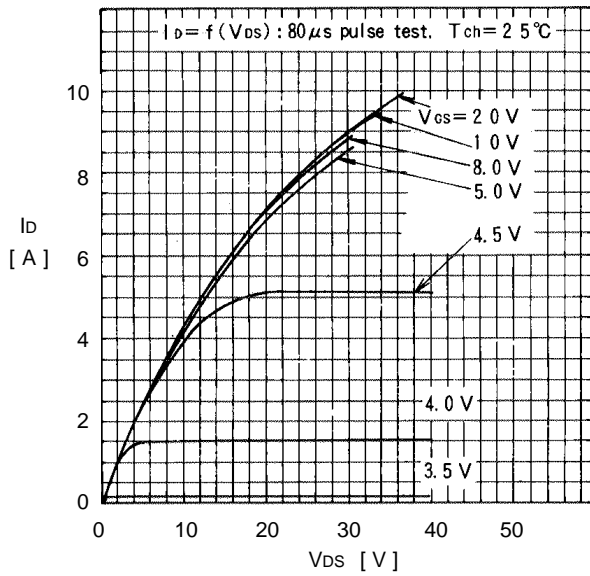

On state resistance vs.  $T_{ch}$

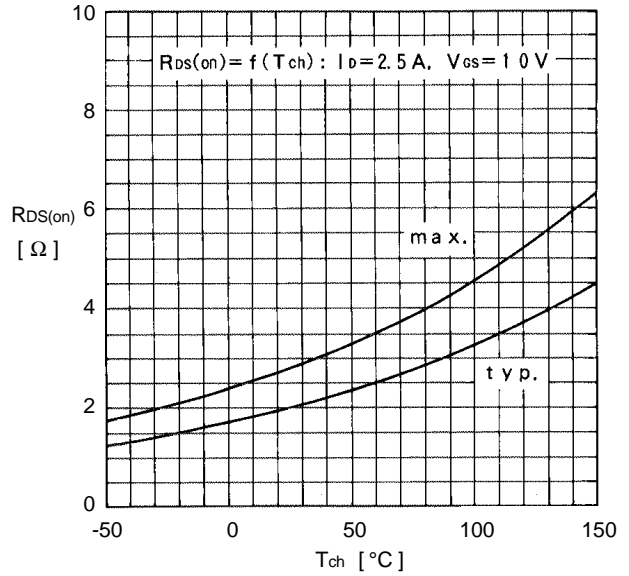

Typical transfer characteristics

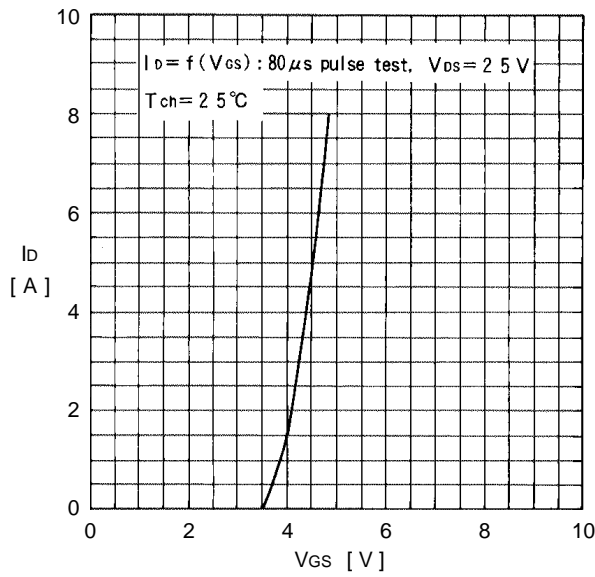

Typical Drain-Source on state resistance vs.  $I_D$

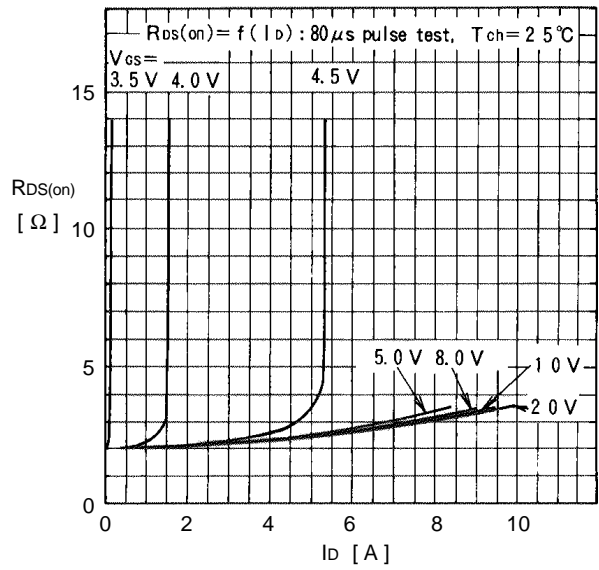

Typical forward transconductance vs.  $I_D$

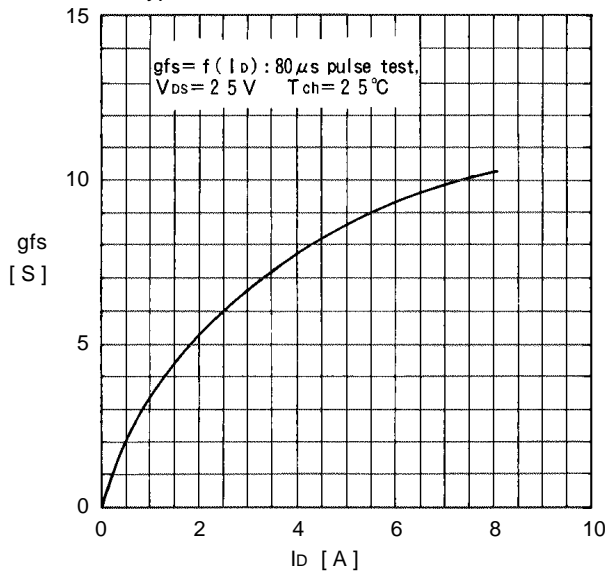

Gate threshold voltage vs.  $T_{ch}$

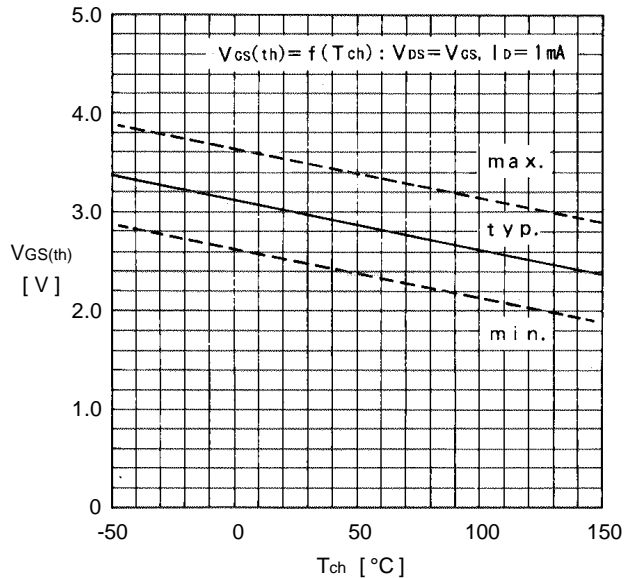

Typical capacitance vs.  $V_{DS}$

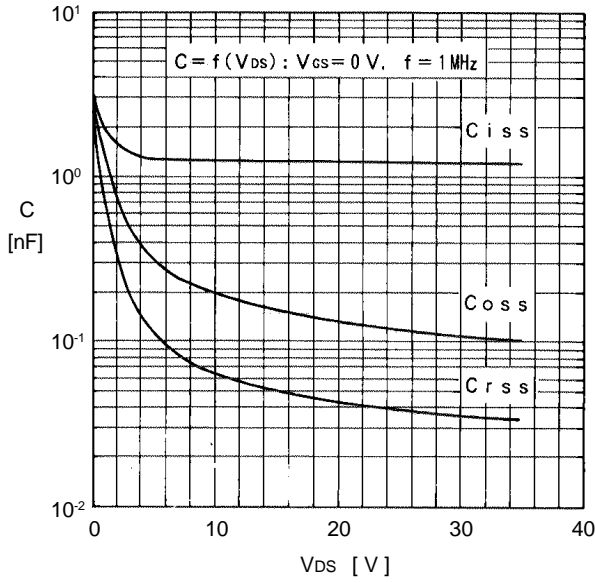

Typical input charge

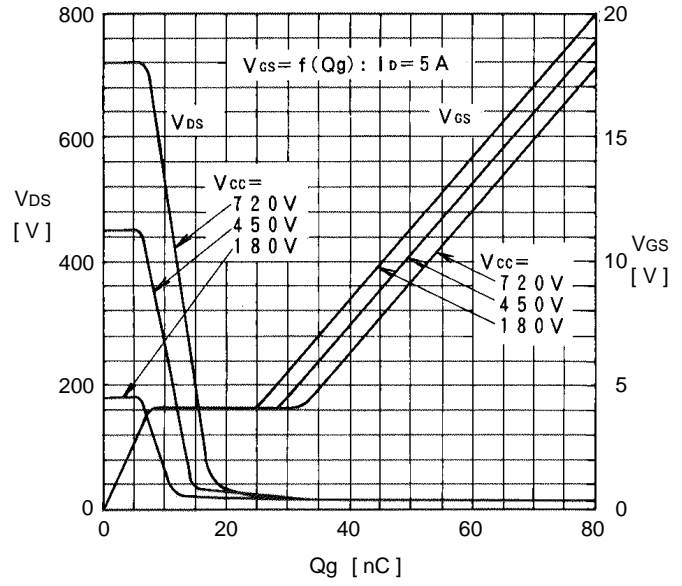

Forward characteristics of reverse diode

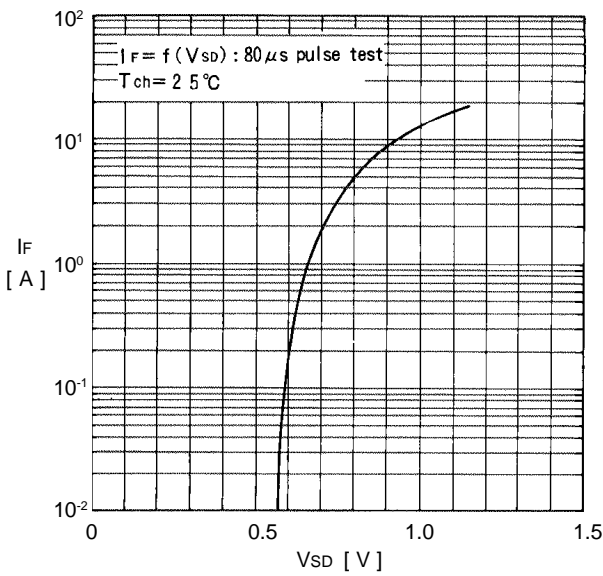

Allowable power dissipation vs.  $T_c$

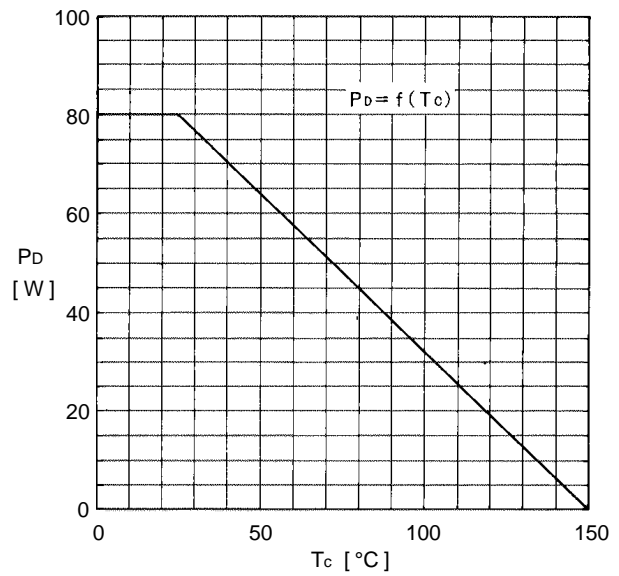

Safe operating area

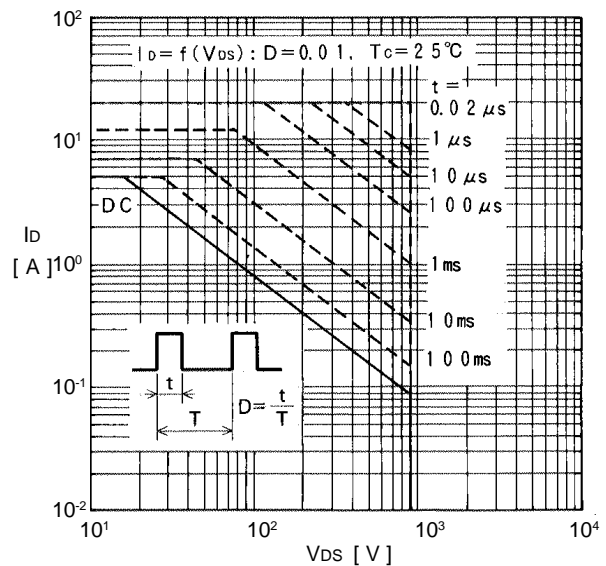

Transient thermal impedance

