

Features

- Alloy diode
- Popular series for rough service
- Stud cathode and stud anode version

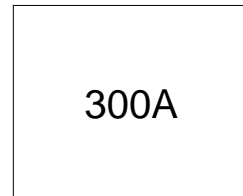

Typical Applications

- Welders
- Power supplies
- Motor controls
- Battery chargers
- General industrial current rectification

Major Ratings and Characteristics

Parameters	300U	Units
$I_{F(AV)}$	300	A
@ T_C	150	°C
I_{FSM} @ 50Hz	6550	A
@ 60Hz	6850	A
i^2t @ 50Hz	214	KA ² s
@ 60Hz	195	KA ² s
V_{RRM} range	100 to 600	V
T_J	-65 to 200	°C

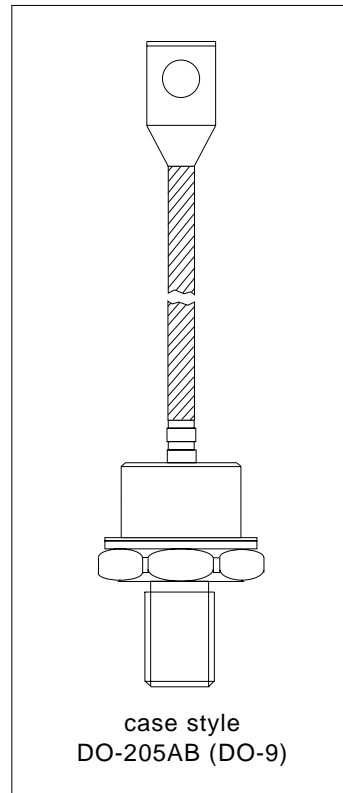

300U(R) Series

Bulletin I2039 rev. C 03/03

International
IR Rectifier

ELECTRICAL SPECIFICATIONS

Voltage Ratings

Type number	Voltage Code	V_{RRM} , maximum repetitive peak reverse voltage V	V_{RSM} , maximum non-repetitive peak rev. voltage V	I_{RRM} max. $T_J = 175^\circ\text{C}$ mA
300U	10	100	200	40
	20	200	300	
	30	300	400	
	40	400	500	
	60	600	700	

Forward Conduction

Parameter	300U	Units	Conditions
$I_{F(AV)}$ Max. average forward current @ Case temperature	300	A	180° conduction, half sine wave
	130	°C	
I_{FSM} Max. peak, one-cycle forward, non-repetitive surge current	6550	A	t = 10ms No voltage reappplied
	6850		t = 8.3ms
	5500		t = 10ms 100% V_{RRM} reappplied
	5750		t = 8.3ms
I^2t Maximum I^2t for fusing	214	KA ² s	t = 10ms No voltage reappplied
	195		t = 8.3ms
	151		t = 10ms 100% V_{RRM} reappplied
	138		t = 8.3ms
$I^2\sqrt{t}$ Maximum $I^2\sqrt{t}$ for fusing	2140	KA ² √s	t = 0.1 to 10ms, no voltage reappplied
$V_{F(TO)}$ Max. value of threshold voltage	0.610	V	$T_J = 200^\circ\text{C}$
r_f Max. value of forward slope resistance	0.751	mΩ	
V_{FM} Max. peak forward voltage	1.40	V	$I_{peak} = 942\text{A}$, $T_J = 25^\circ\text{C}$

Thermal and Mechanical Specifications

Parameter	300U(R)	Units	Conditions
T_J Max. junction operating temperature range	-65 to 200	°C	
T_{stg} Max. storage temperature range	-65 to 200		
R_{thJC} Max. thermal resistance, junction to case	0.18	K/W	DC operation
R_{thCS} Max. thermal resistance, case to heatsink	0.08		Mounting surface, smooth, flat and greased
T Max. allowed mounting torque +0 -20%	37	Nm	Not lubricated threads
	28		Lubricated threads
wt Approximate weight	250	g	
Case style	DO-205AB (DO-9)**		JEDEC (See Outline Table)

** 302U-A uses IR case style B-26

ΔR_{thJC} Conduction

(The following table shows the increment of thermal resistance R_{thJC} when devices operate at different conduction angles than DC)

Conduction angle	Sinusoidal conduction	Rectangular conduction	Units	Conditions
180°	0.020	0.015	K/W	$T_J = T_J \text{ max.}$
120°	0.024	0.025		
90°	0.031	0.034		
60°	0.045	0.047		
30°	0.077	0.077		

Ordering Information Table

Device Code

300

U

R

060

A

1

2

3

4

5

1 - 300 = Standard 300U device
 302 = 300U Top Threaded version

2 - U = Essential Part Number

3 - R = Stud Reverse Polarity (Anode to Stud)
 None = Stud Normal Polarity (Cathode to Stud)

4 - Voltage code: Code x 10 = V_{RRM} (See Voltage Ratings table)

5 - A = Essential Part Number

NOTE: For Metric Device M16 x 1.5 Contact Factory

300U(R) Series

Bulletin I2039 rev. C 03/03

Outline Table

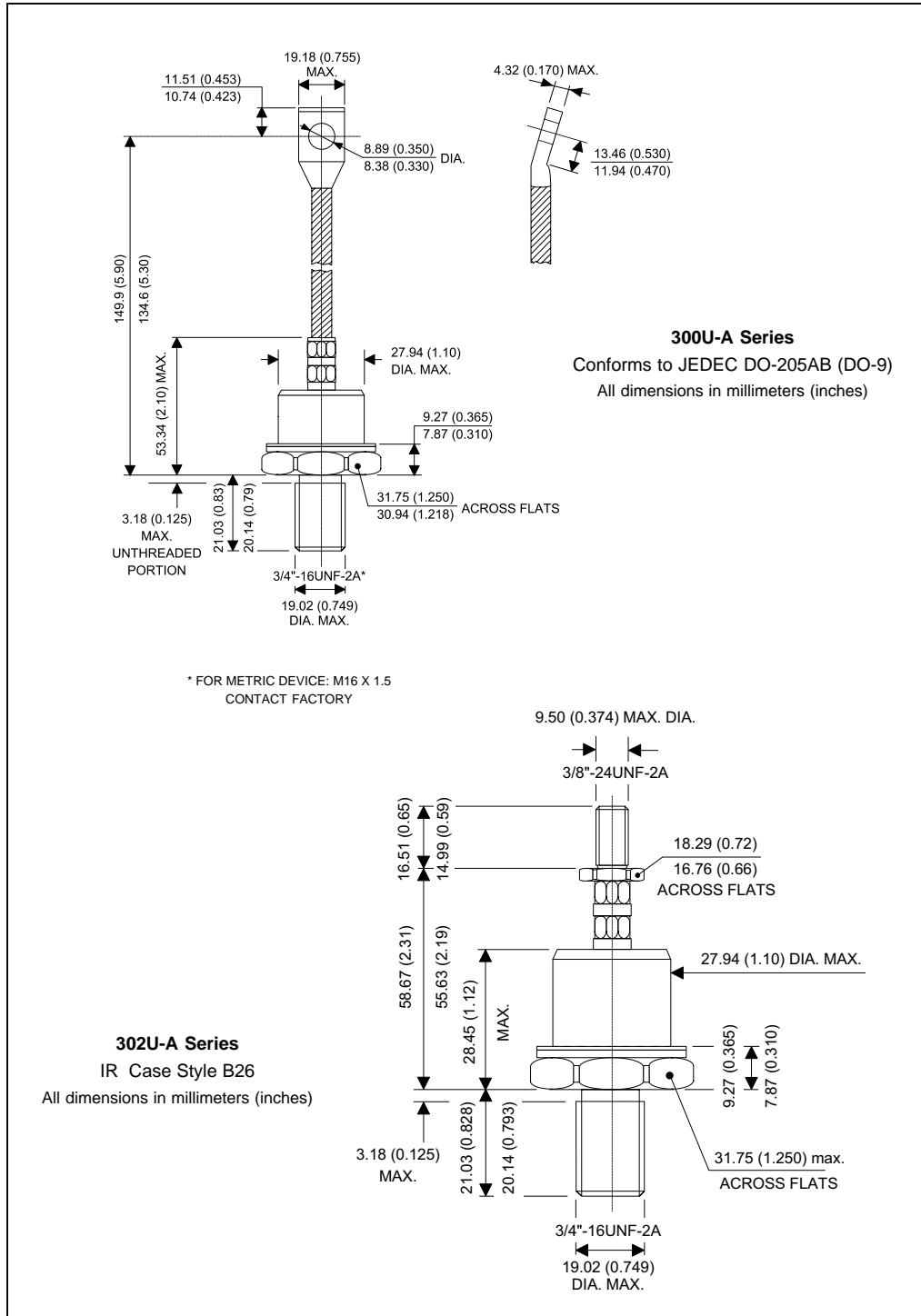

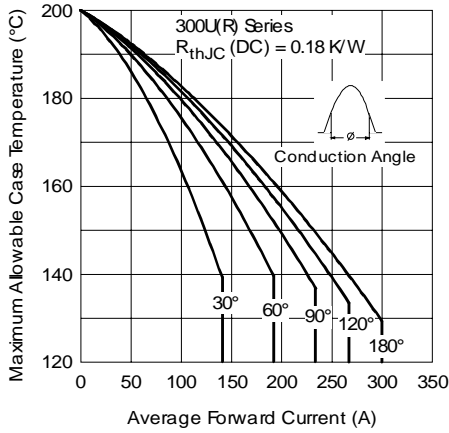

Fig. 1 - Current Ratings Characteristics

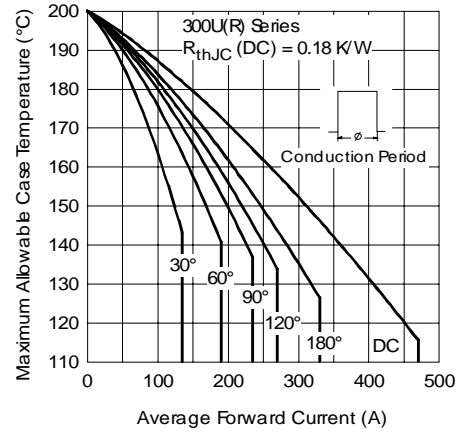

Fig. 2 - Current Ratings Characteristics

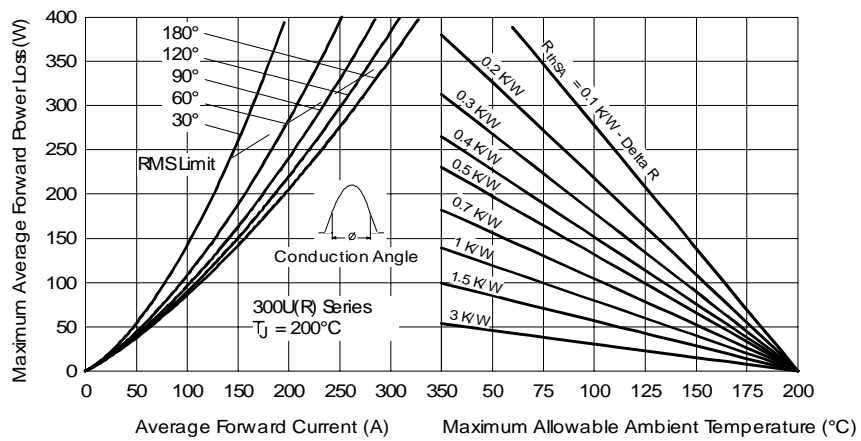

Fig. 3 - Forward Power Loss Characteristics

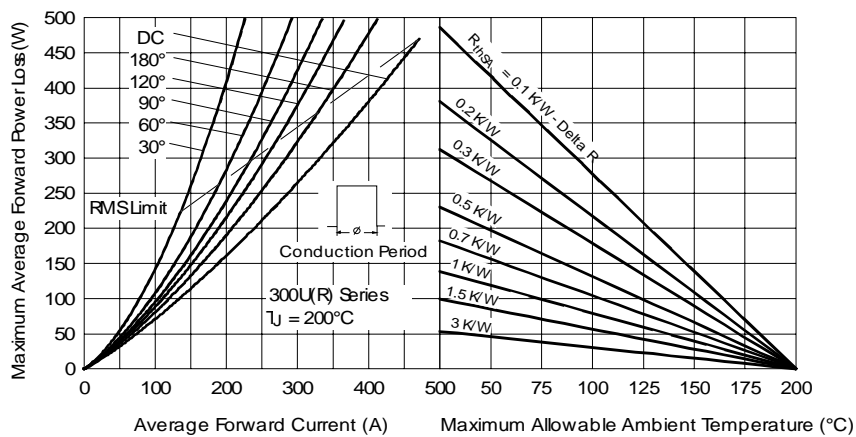

Fig. 4 - Forward Power Loss Characteristics

300U(R) Series

Bulletin I2039 rev. C 03/03

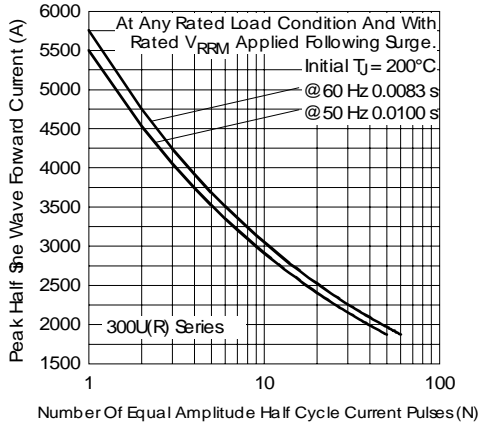

Fig. 5 - Maximum Non-Repetitive Surge Current

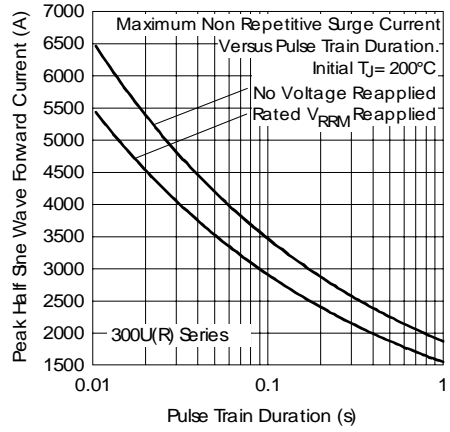

Fig. 6 - Maximum Non-Repetitive Surge Current

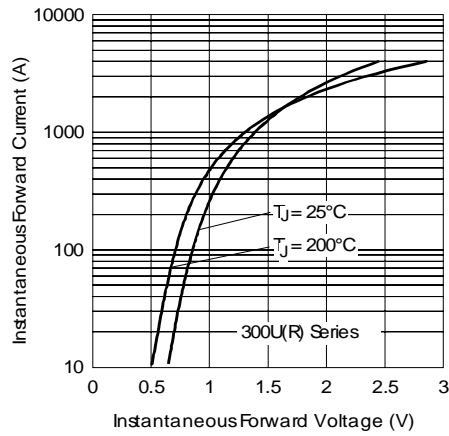

Fig. 7 - Forward Voltage Drop Characteristics

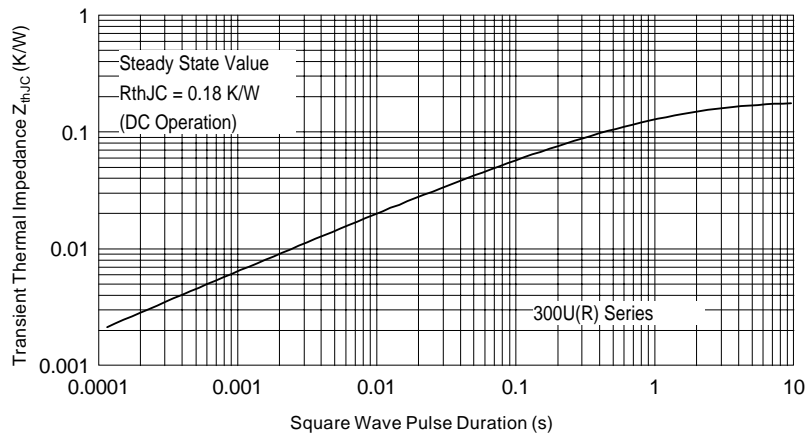

Fig. 8 - Thermal Impedance Z_{thJC} Characteristic

Data and specifications subject to change without notice.
This product has been designed and qualified for Industrial Level.
Qualification Standards can be found on IR's Web site.

International
IOR Rectifier

IR WORLD HEADQUARTERS: 233 Kansas St., El Segundo, California 90245, USA Tel: (310) 252-7105
TAC Fax: (310) 252-7309
Visit us at www.irf.com for sales contact information. 03/03