

International
IOR Rectifier

SAFEIR Series
 30TPS..

PHASE CONTROL SCR



$$V_T < 1.3V @ 20A$$

$$I_{TSM} = 300A$$

$$V_{RRM} 800 \text{ to } 1600V$$

Description/Features

The 30TPS.. **SAFEIR** series of silicon controlled rectifiers are specifically designed for medium power switching and phase control applications. The glass passivation technology used has reliable operation up to 125°C junction temperature.

Typical applications are in input rectification (soft start) and these products are designed to be used with International Rectifier input diodes, switches and output rectifiers which are available in identical package outlines.

Major Ratings and Characteristics

Characteristics	30TPS..	Units
$I_{T(AV)}$ Sinusoidal waveform	20	A
I_{RMS}	30	A
V_{RRM}/V_{DRM}	up to 1600	V
I_{TSM}	300	A
V_T @ 20 A, $T_J = 25^\circ\text{C}$	1.3	V
dv/dt	500	V/ μs
di/dt	150	A/ μs
T_J	-40 to 125	$^\circ\text{C}$

Package Outline

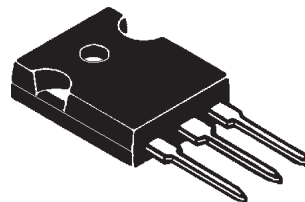

TO-247AC

Voltage Ratings

Part Number	V_{RRM}/V_{DRM} , max. repetitive peak and off-state voltage V	V_{RSM} , maximum non repetitive peak reverse voltage V	I_{RRM}/I_{DRM} 125°C mA
30TPS08	800	900	10
30TPS12	1200	1300	
30TPS16	1600	1700	

Absolute Maximum Ratings

Parameters	30TPS..	Units	Conditions	
$I_{T(AV)}$ Max. Average On-state Current	20	A	@ $T_C = 95^\circ\text{C}$, 180° conduction half sine wave	
I_{RMS} Max. RMS On-state Current	30			
I_{TSM} Max. Peak One Cycle Non-Repetitive Surge Current	250		10ms Sine pulse, rated V_{RRM} applied	
	300	10ms Sine pulse, no voltage reapplied		
I^2t Max. I^2t for Fusing	310	A^2s	10ms Sine pulse, rated V_{RRM} applied	
	442		10ms Sine pulse, no voltage reapplied	
$I^2\sqrt{t}$ Max. $I^2\sqrt{t}$ for Fusing	4420	$A^2\sqrt{s}$	t=0.1 to 10ms, no voltage reapplied	
V_{TM} Max. On-state Voltage Drop	1.3	V	@ 20A, $T_J = 25^\circ\text{C}$	
r_t On-state Slope Resistance	12	$m\Omega$	$T_J = 125^\circ\text{C}$	
$V_{T(TO)}$ Threshold Voltage	1.0	V		
I_{RM}/I_{DM} Max. Reverse and Direct Leakage Current	0.5	mA	$T_J = 25^\circ\text{C}$	$V_R = \text{rated } V_{RRM}/V_{DRM}$
	10		$T_J = 125^\circ\text{C}$	
I_H Max. Holding Current	100	mA	Anode Supply = 6V, Resistive load, Initial $I_T = 1A$	
I_L Max. Latching Current	200	mA	Anode Supply = 6V, Resistive load	
dv/dt Max. Rate of Rise of off-state Voltage	500	V/ μs		
di/dt Max. Rate of Rise of turned-on Current	150	A/ μs		

Triggering

Parameters	30TPS..	Units	Conditions
P_{GM} Max. Peak Gate Power	8.0	W	
$P_{G(AV)}$ Max. Average Gate Power	2.0		
+ I_{GM} Max. Peak Positive Gate Current	1.5	A	
- V_{GM} Max. Peak Negative Gate Voltage	10	V	
I_{GT} Max. Required DC Gate Current to Trigger	60	mA	Anode supply = 6V, resistive load, $T_J = -10^\circ\text{C}$
	45		Anode supply = 6V, resistive load, $T_J = 25^\circ\text{C}$
	20		Anode supply = 6V, resistive load, $T_J = 125^\circ\text{C}$
V_{GT} Max. Required DC Gate Voltage to Trigger	2.5	V	Anode supply = 6V, resistive load, $T_J = -10^\circ\text{C}$
	2.0		Anode supply = 6V, resistive load, $T_J = 25^\circ\text{C}$
	1.0		Anode supply = 6V, resistive load, $T_J = 125^\circ\text{C}$
V_{GD} Max. DC Gate Voltage not to Trigger	0.25		$T_J = 125^\circ\text{C}$, $V_{DRM} = \text{rated value}$
I_{GD} Max. DC Gate Current not to Trigger	2.0	mA	$T_J = 125^\circ\text{C}$, $V_{DRM} = \text{rated value}$

Switching

Parameters	30TPS..	Units	Conditions
t_{gt} Typical Turn-on Time	0.9	μs	$T_J = 25^\circ\text{C}$
t_{rr} Typical Reverse Recovery Time	4		$T_J = 125^\circ\text{C}$
t_q Typical Turn-off Time	110		

Thermal-Mechanical Specifications

Parameters	30TPS..	Units	Conditions
T_J Max. Junction Temperature Range	- 40 to 125	$^\circ\text{C}$	
T_{stg} Max. Storage Temperature Range	- 40 to 125		
R_{thJC} Max. Thermal Resistance Junction to Case	0.8	$^\circ\text{C/W}$	DC operation
R_{thJA} Max. Thermal Resistance Junction to Ambient	40		
R_{thCS} Max. Thermal Resistance Case to Heatsink	0.2		Mounting surface, smooth and greased
wt Approximate Weight	6 (0.21)	g (oz.)	
T Mounting Torque	Min.	6 (5)	
	Max.	12 (10)	
Case Style	TO-247AC		Jedec (Modified)

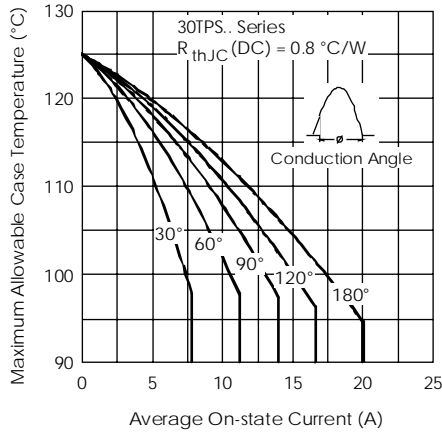

Fig. 1 - Current Rating Characteristics

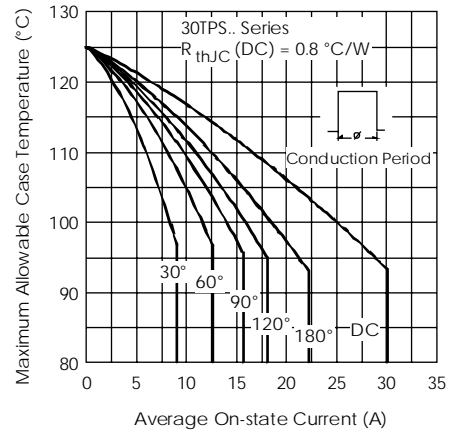

Fig. 2 - Current Rating Characteristics

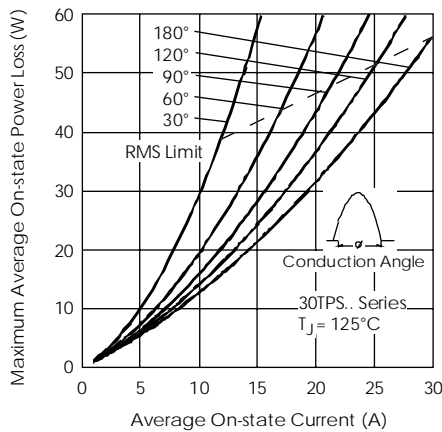

Fig. 3 - On-state Power Loss Characteristics

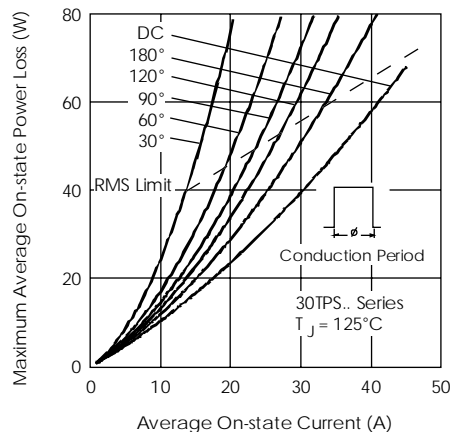

Fig. 4 - On-state Power Loss Characteristics

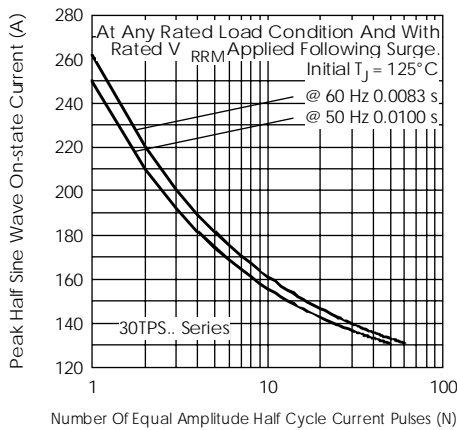

Fig. 5 - Maximum Non-Repetitive Surge Current

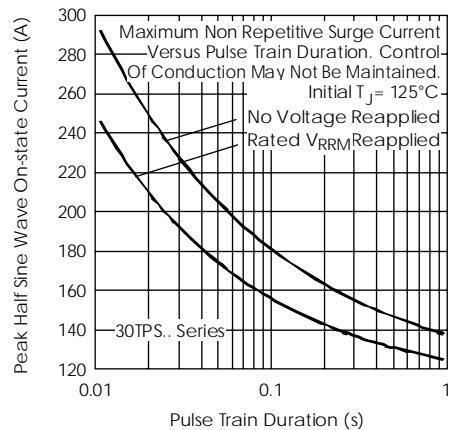

Fig. 6 - Maximum Non-Repetitive Surge Current

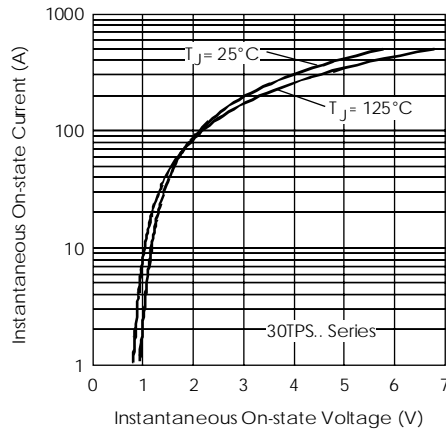

Fig. 7 - On-state Voltage Drop Characteristics

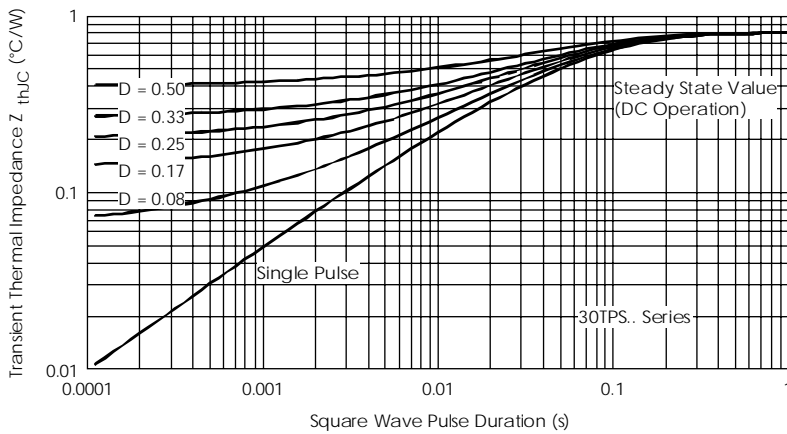

Fig. 8 - Thermal Impedance Z_{thjC} Characteristics

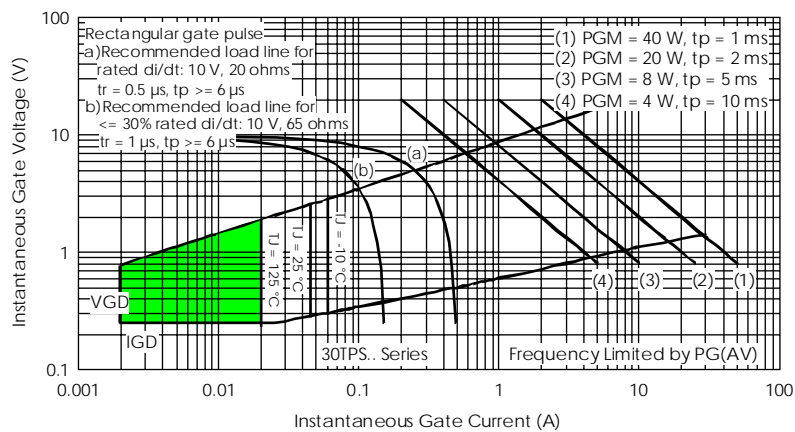
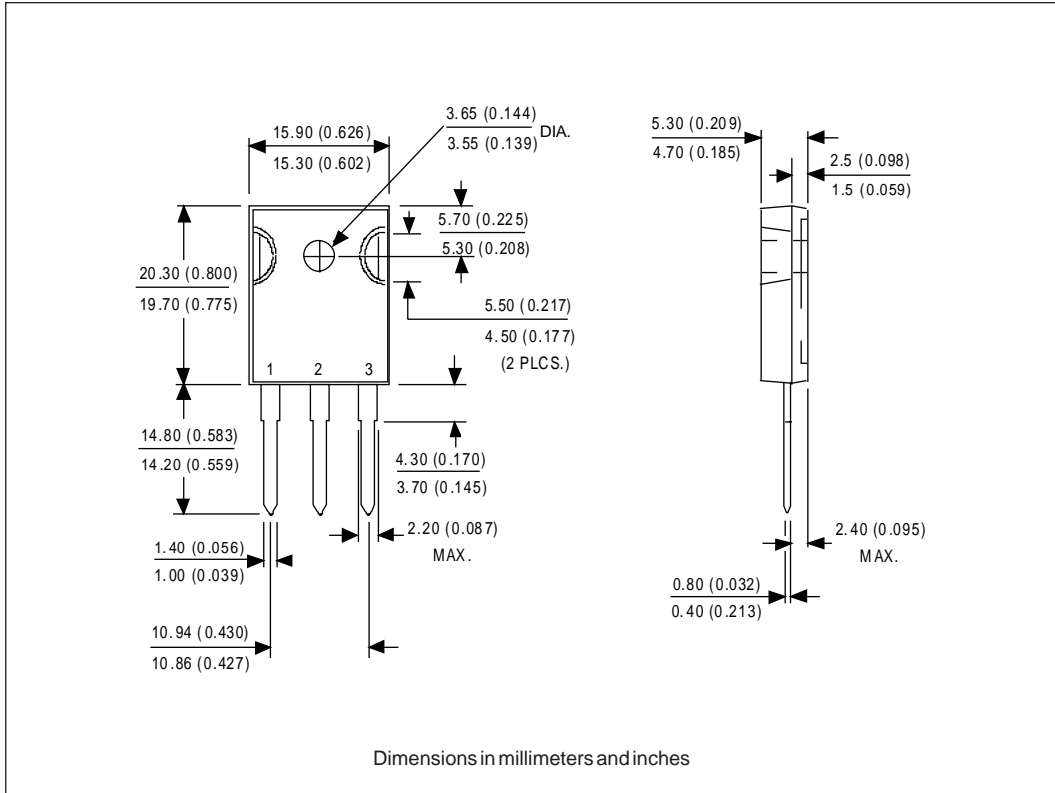

Fig. 9 - Gate Characteristics

Outline Table



Ordering Information Table

