

### STANDARD RECOVERY DIODES

Stud Version

#### Features

- High surge current capability
- Designed for a wide range of applications
- Stud cathode and stud anode version
- Leaded version available
- Types up to 1600V  $V_{RRM}$

40 A

#### Typical Applications

- Battery charges
- Converters
- Power supplies
- Machine tool controls

#### Major Ratings and Characteristics

Parameters	40HF(R)		Units
	10 to 120	140 to 160	
$I_{F(AV)}$	40	40	A
@ $T_C$	140	110	°C
$I_{F(RMS)}$	62		A
$I_{FSM}$	@ 50Hz	570	A
	@ 60Hz	595	A
$I^2t$	@ 50Hz	1600	A <sup>2</sup> s
	@ 60Hz	1450	A <sup>2</sup> s
$V_{RRM}$ range	100 to 1200	1400 to 1600	V
$T_J$ range	- 65 to 190	- 65 to 160	°C



## 40HF(R) Series

Bulletin I20201 rev. A 09/98

International  
IR Rectifier

### ELECTRICAL SPECIFICATIONS

#### Voltage Ratings

Type number	Voltage Code	V <sub>RRM</sub> : maximum repetitive peak reverse voltage V	V <sub>RSM</sub> : maximum non-repetitive peak reverse voltage V	V <sub>R(BR)</sub> : minimum avalanche voltage V (1)	I <sub>RRM</sub> max. @ T <sub>J</sub> = T <sub>J</sub> max. mA
40HF(R)	10	100	200	--	15
	20	200	300	--	
	40	400	500	500	
	60	600	720	725	9
	80	800	960	950	
	100	1000	1200	1150	
	120	1200	1440	1350	
	140	1400	1650	1550	4.5
160	1600	1900	1750		

(1) Avalanche version only available from V<sub>RRM</sub> 400V to 1600V.

#### Forward Conduction

Parameter	40HF(R)		Units	Conditions		
	10 to 120	140 to 160				
I <sub>F(AV)</sub> Max. average forward current @ Case temperature	40	40	A	180° conduction, half sine wave		
	140	110	°C			
I <sub>F(RMS)</sub> Max. RMS forward current	62		A			
P <sub>R</sub> Maximum non-repetitive peak reverse power	11		K · W	10µs square pulse, T <sub>J</sub> = T <sub>J</sub> max. <b>see note (2)</b>		
I <sub>F(SM)</sub> Max. peak, one-cycle forward, non-repetitive surge current	570	A	A	t = 10ms	No voltage reappplied	Sinusoidal half wave, Initial T <sub>J</sub> = T <sub>J</sub> max.
	595			t = 8.3ms		
	480			t = 10ms	100% V <sub>RRM</sub> reappplied	
	500			t = 8.3ms		
I <sup>2</sup> t Maximum I <sup>2</sup> t for fusing	1600	A <sup>2</sup> s	A <sup>2</sup> s	t = 10ms	No voltage reappplied	
	1450			t = 8.3ms		
	1150			t = 10ms	100% V <sub>RRM</sub> reappplied	
	1050			t = 8.3ms		
I <sup>2</sup> √t Maximum I <sup>2</sup> √t for fusing	16000		A <sup>2</sup> √s	t = 0.1 to 10ms, no voltage reappplied		
V <sub>F(TO)1</sub> Low level value of threshold voltage	0.65		V	(16.7% × π × I <sub>F(AV)</sub> < I < π × I <sub>F(AV)</sub> ), T <sub>J</sub> = T <sub>J</sub> max.		
V <sub>F(TO)2</sub> High level value of threshold voltage	0.70			(I > π × I <sub>F(AV)</sub> ), T <sub>J</sub> = T <sub>J</sub> max.		
r <sub>f1</sub> Low level value of forward slope resistance	4.29		mΩ	(16.7% × π × I <sub>F(AV)</sub> < I < π × I <sub>F(AV)</sub> ), T <sub>J</sub> = T <sub>J</sub> max.		
r <sub>f2</sub> High level value of forward slope resistance	3.98			(I > π × I <sub>F(AV)</sub> ), T <sub>J</sub> = T <sub>J</sub> max.		
V <sub>FM</sub> Max. forward voltage drop	1.30		V	I <sub>pk</sub> = 125A, T <sub>J</sub> = 25°C, t <sub>p</sub> = 400µs rectangular wave		

(2) Available only for Avalanche version, all other parameters the same as 40HF.

Thermal and Mechanical Specifications

Parameter	40HF(R)		Units	Conditions
	10 to 120	140 to 160		
T <sub>J</sub> Max. junction operating temperature range	-65 to 190	-65 to 160	°C	
T <sub>stg</sub> Max. storage temperature range	-65 to 190	-65 to 160		
R <sub>thJC</sub> Max. thermal resistance, junction to case	1.0		K/W	DC operation
R <sub>thCS</sub> Max. thermal resistance, case to heatsink	0.25			Mounting surface, smooth, flat and greased
T Max. allowed mounting torque ±10%	2.3 - 3.4		Nm	Not lubricated threads
	20 - 30		lbf·in	
wt Approximate weight	17 (0.6)		g (oz)	
Case style	DO-203AB (DO5)			See Outline Table

$\Delta R_{thJC}$  Conduction

(The following table shows the increment of thermal resistance R<sub>thJC</sub> when devices operate at different conduction angles than DC)

Conduction angle	Sinusoidal conduction	Rectangular conduction	Units	Conditions
180°	0.14	0.10	K/W	T <sub>J</sub> = T <sub>J</sub> max.
120°	0.16	0.17		
90°	0.21	0.22		
60°	0.30	0.31		
30°	0.50	0.50		

Ordering Information Table

Device Code											
<table border="1" style="margin: auto;"> <tr> <td style="padding: 5px;">40</td> <td style="padding: 5px;">HF</td> <td style="padding: 5px;">R</td> <td style="padding: 5px;">160</td> <td style="padding: 5px;">M</td> </tr> <tr> <td style="text-align: center;">①</td> <td style="text-align: center;">②</td> <td style="text-align: center;">③</td> <td style="text-align: center;">④</td> <td style="text-align: center;">⑤</td> </tr> </table>	40	HF	R	160	M	①	②	③	④	⑤	<p><b>1</b> - 40 = Standard device                      41 = Not isolated lead                      42 = Isolated lead with silicone sleeve                      (Red = Reverse polarity)                      (Blue = Normal polarity)</p> <p><b>2</b> - HF = Standard diode                      HA = Avalanche diode</p> <p><b>3</b> - None = Stud Normal Polarity (Cathode to Stud)                      R = Stud Reverse Polarity (Anode to Stud)</p> <p><b>4</b> - Voltage code: Code x 10 = V<sub>RRM</sub> (See Voltage Ratings table)</p> <p><b>5</b> - None = Stud base DO-203AB (DO-5) 1/4" 28UNF-2A                      M = Stud base DO-203AB (DO-5) M6 X 1 - (Not available for Avalanche diodes)</p>
40	HF	R	160	M							
①	②	③	④	⑤							

# 40HF(R) Series

Bulletin I20201 rev. A 09/98

## Outlines Table

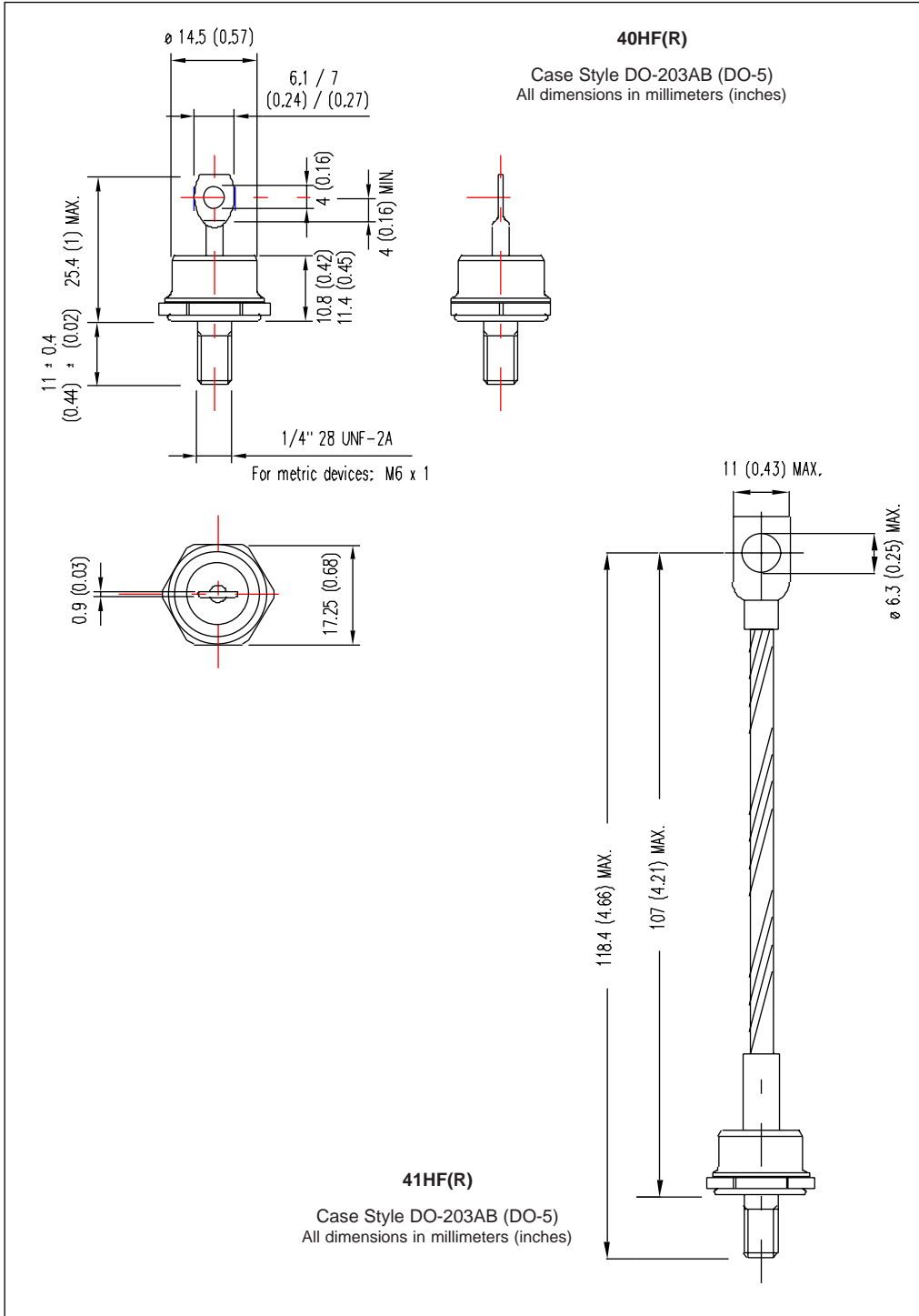

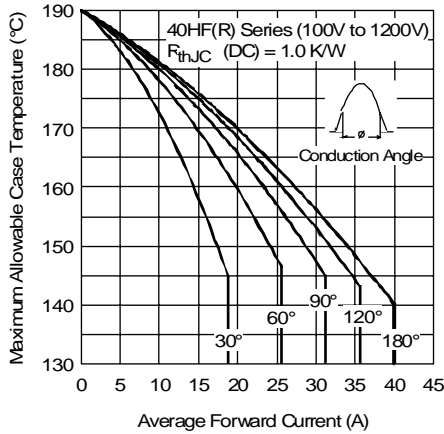

Fig. 1 - Current Ratings Characteristics

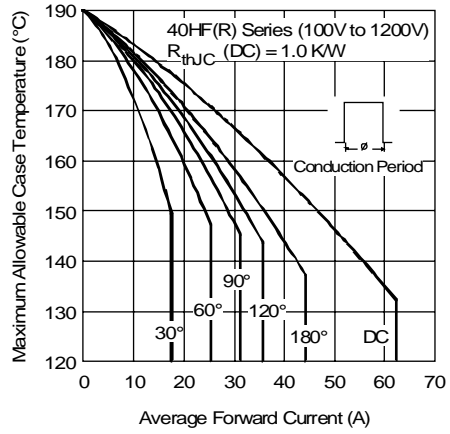

Fig. 2 - Current Ratings Characteristics

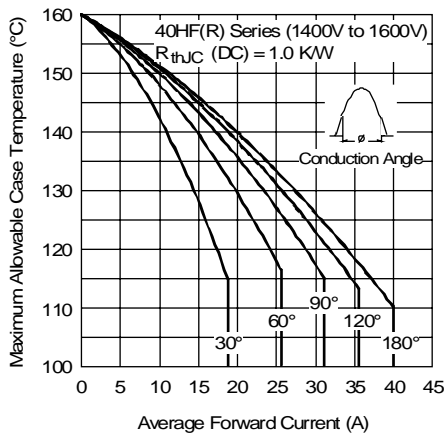

Fig. 3 - Current Ratings Characteristics

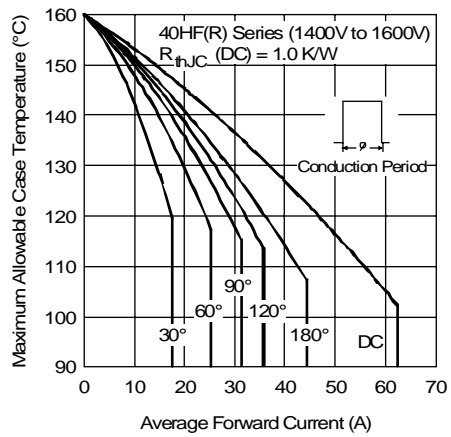

Fig. 4 - Current Ratings Characteristics

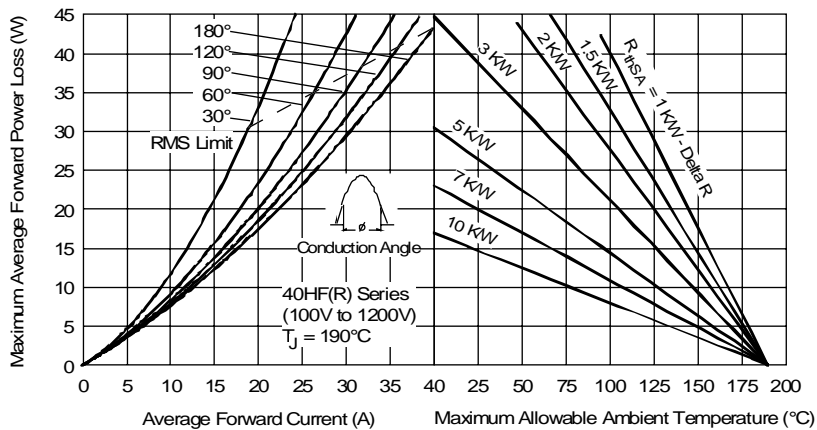

Fig. 5 - Forward Power Loss Characteristics

# 40HF(R) Series

Bulletin I20201 rev. A 09/98

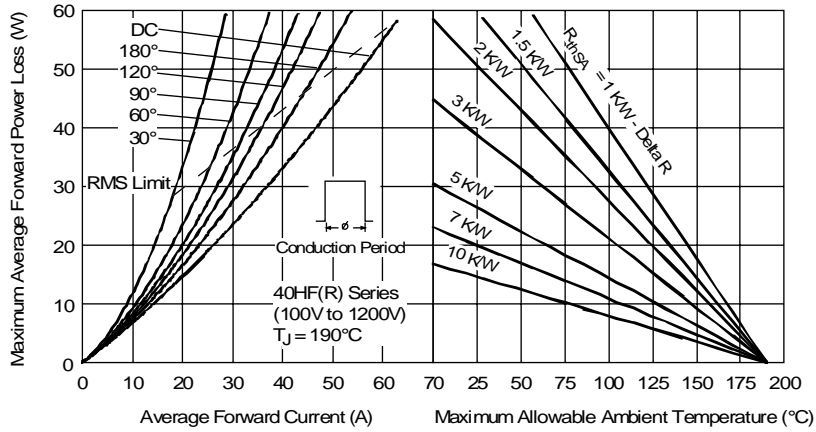

Fig. 6 - Forward Power Loss Characteristics

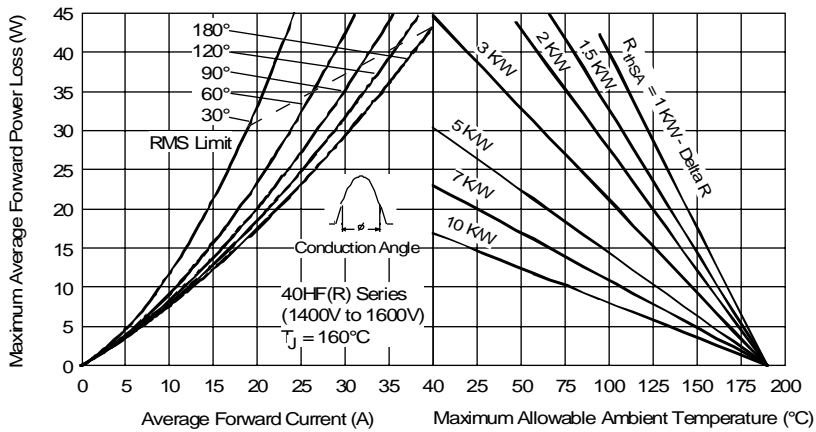

Fig. 7 - Forward Power Loss Characteristics

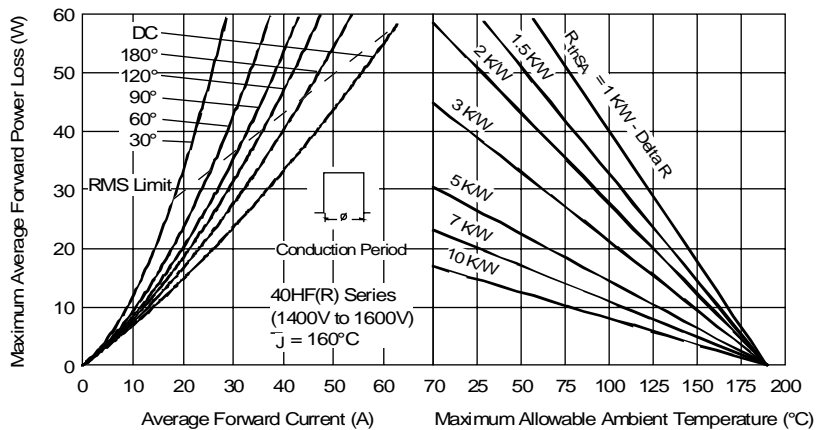

Fig. 8 - Forward Power Loss Characteristics

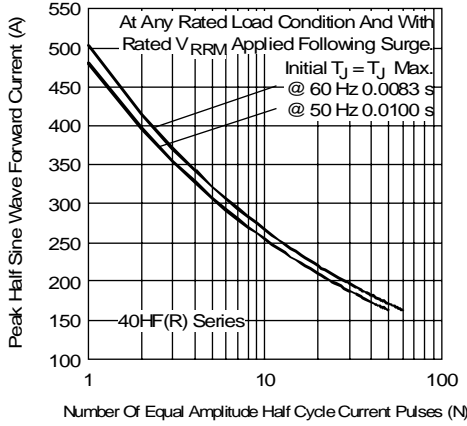

Fig. 9 - Maximum Non-Repetitive Surge Current

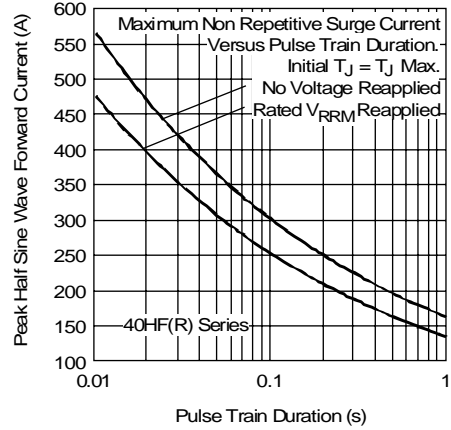

Fig. 10 - Maximum Non-Repetitive Surge Current

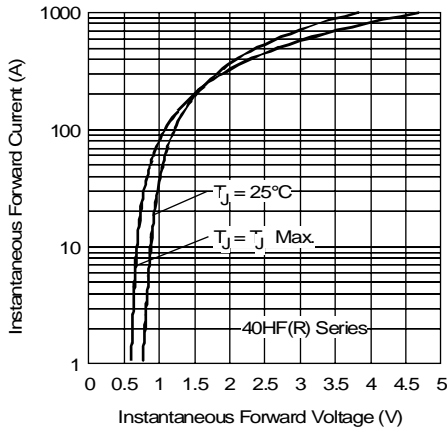

Fig. 11 - Forward Voltage Drop Characteristics

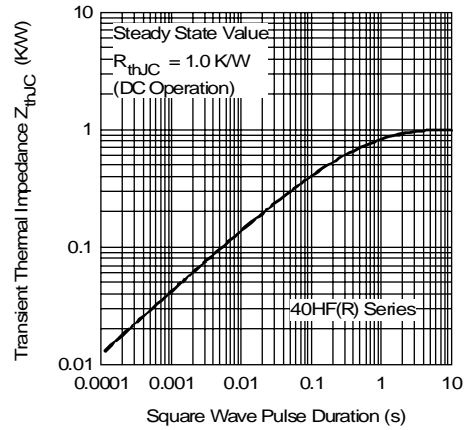

Fig. 12 - Thermal Impedance  $Z_{thJC}$  Characteristics