

# 6MBI450U-170



## IGBT Module U-Series 1700V / 450A 6 in one-package

### ■ Features

- High speed switching
- Voltage drive
- Low inductance module structure

### ■ Applications

- Inverter for Motor drive
- AC and DC Servo drive amplifier
- Uninterruptible power supply
- Industrial machines, such as Welding machines

### ■ Maximum ratings and characteristics

#### ● Absolute maximum ratings (at Tc=25°C unless otherwise specified)

Item	Symbol	Conditions	Rating	Unit	
Collector-Emitter voltage	V <sub>CES</sub>		1700	V	
Gate-Emitter voltage	V <sub>GES</sub>		±20	V	
Collector current	I <sub>c</sub>	Continuous	T <sub>c</sub> =25°C	600	A
			T <sub>c</sub> =80°C	450	
	I <sub>cp</sub>	1ms	T <sub>c</sub> =25°C	1200	
			T <sub>c</sub> =80°C	900	
	-I <sub>c</sub>			450	
-I <sub>c</sub> pulse			900		
Collector Power Dissipation	P <sub>c</sub>	1 device	2080	W	
Junction temperature	T <sub>j</sub>		+150	°C	
Storage temperature	T <sub>stg</sub>		-40 to +125		
Isolation voltage	between terminal and copper base *1	V <sub>iso</sub>	AC:1min.	3400	VAC
	between thermistor and others *2				
Screw Torque	Mounting *3	-		3.5	N·m
	Terminals *4				

\*1 : All terminals should be connected together when isolation test will be done.

\*2 : Two thermistor terminals should be connected together, each other terminals should be connected together and shorted to base plate when isolation test will be done.

\*3 :Recommendable value : 2.5 to 3.5 N·m(M5) \*4 :Recommendable value : 3.5 to 4.5 N·m(M6)

#### ● Electrical characteristics (at Tj=25°C unless otherwise specified)

Item	Symbols	Conditions	Characteristics			Unit	
			Min.	Typ.	Max.		
Zero gate voltage collector current	ICES	V <sub>GE</sub> =0V, V <sub>CES</sub> =1700V	-	-	3.0	mA	
Gate-Emitter leakage current	IGES	V <sub>CE</sub> =0V, V <sub>GE</sub> =±20V	-	-	600	nA	
Gate-Emitter threshold voltage	V <sub>GE(th)</sub>	V <sub>CE</sub> =20V, I <sub>c</sub> =450mA	4.5	6.5	8.5	V	
Collector-Emitter saturation voltage	V <sub>CE(sat)</sub> (terminal)	V <sub>GE</sub> =15V, I <sub>c</sub> =450A	T <sub>j</sub> =25°C	-	2.50	3.00	V
			T <sub>j</sub> =125°C	-	2.85	-	
	V <sub>CE(sat)</sub> (chip)		T <sub>j</sub> =25°C	-	2.05	2.55	
			T <sub>j</sub> =125°C	-	2.40	-	
Input capacitance	C <sub>ies</sub>	V <sub>CE</sub> =10V, V <sub>GE</sub> =0V, f=1MHz	-	45	-	nF	
Turn-on time	t <sub>on</sub>	V <sub>CC</sub> =900V	-	0.58	1.20	μs	
	t <sub>r</sub>	I <sub>c</sub> =450A	-	0.32	0.60		
	t <sub>r(i)</sub>	V <sub>GE</sub> =±15V	-	0.10	-		
Turn-off time	t <sub>off</sub>	R <sub>G</sub> =1.1 Ω	-	0.80	1.50	μs	
	t <sub>f</sub>		-	0.15	0.30		
Forward on voltage	V <sub>F</sub> (terminal)	V <sub>GE</sub> =0V I <sub>F</sub> =450A	T <sub>j</sub> =25°C	-	2.25	3.00	V
			T <sub>j</sub> =125°C	-	2.45	-	
	V <sub>F</sub> (chip)		T <sub>j</sub> =25°C	-	1.80	2.55	
			T <sub>j</sub> =125°C	-	2.00	-	
Reverse recovery time	t <sub>rr</sub>	I <sub>F</sub> =450A	-	0.3	0.6	μs	
Lead resistance, terminal-chip*5	R lead		-	1.0	-	mΩ	
Thermistor	Resistance	R	T=25°C	-	5000	-	Ω
			T=100°C	465	495	520	
	B value	B	T=25/50°C	3305	3375	3450	K

\*5:Biggest internal terminal resistance among arm.

#### ● Thermal resistance characteristics

Items	Symbols	Conditions	Characteristics			Unit
			Min.	Typ.	Max.	
Thermal resistance	R <sub>th(j-c)</sub>	IGBT	-	-	0.06	°C/W
	R <sub>th(j-c)</sub>	FWD	-	-	0.10	°C/W
Contact Thermal resistance	R <sub>th(c-f)</sub> *6	With thermal compound	-	0.0167	-	°C/W

\*6 : This is the value which is defined mounting on the additional cooling fin with thermal compound.

Characteristics (Representative)

Collector current vs. Collector-Emitter voltage (typ.)

T<sub>j</sub>= 25°C / chip

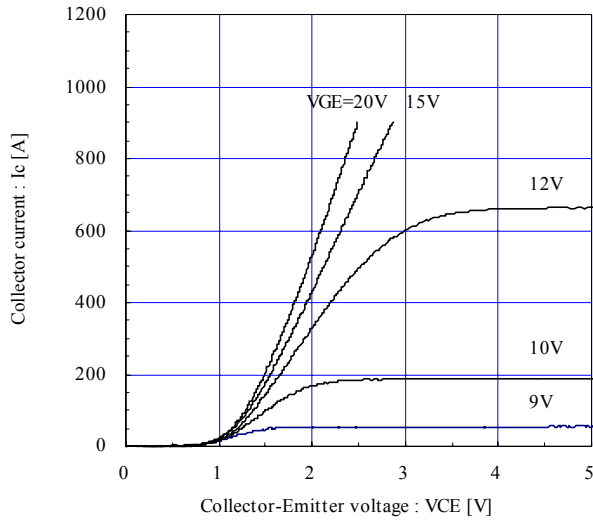

Collector current vs. Collector-Emitter voltage (typ.)

T<sub>j</sub>= 125°C / chip

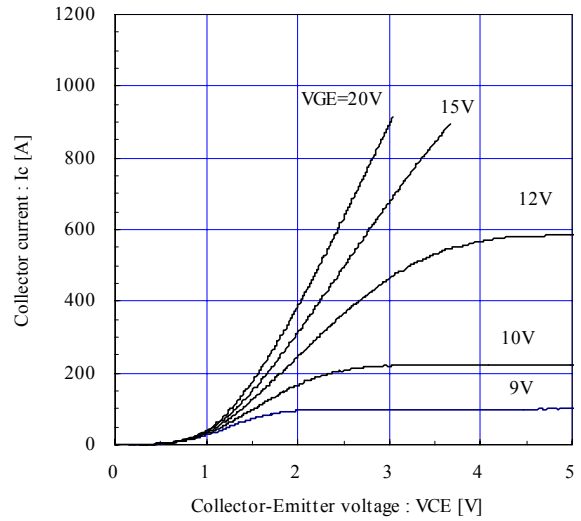

Collector current vs. Collector-Emitter voltage (typ.)

VGE=15V / chip

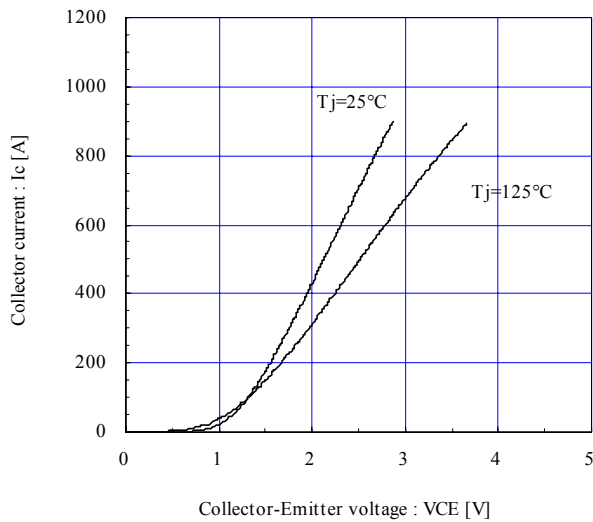

Collector-Emitter voltage vs. Gate-Emitter voltage (typ.)

T<sub>j</sub>=25°C / chip

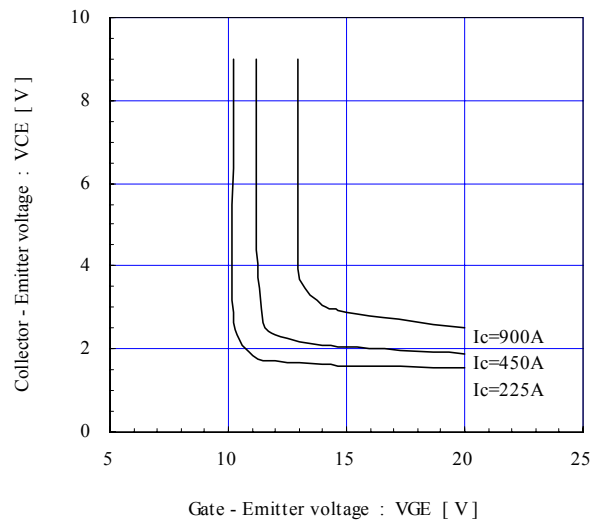

Capacitance vs. Collector-Emitter voltage (typ.)

VGE=0V, f= 1MHz, T<sub>j</sub>= 25°C

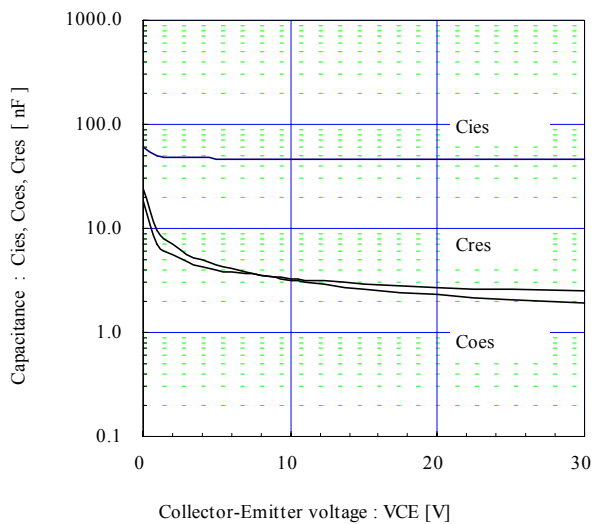

Dynamic Gate charge (typ.)

V<sub>cc</sub>=900V, Ic=450A, T<sub>j</sub>= 25°C

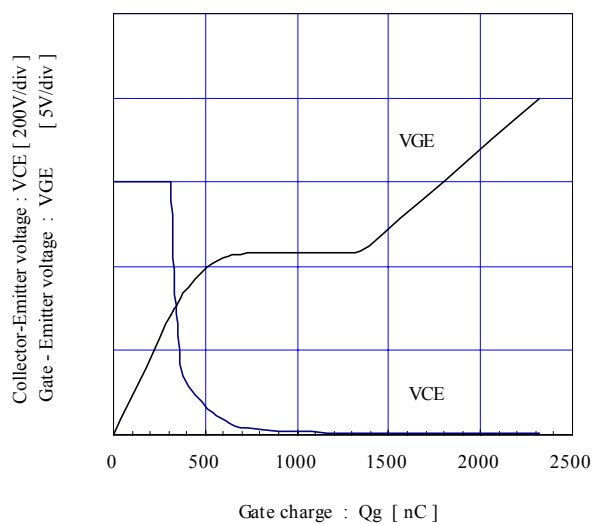

Switching time vs. Collector current (typ.)  
 $V_{cc}=900V, V_{GE}=\pm 15V, R_g=1.1\Omega, T_j=25^\circ C$

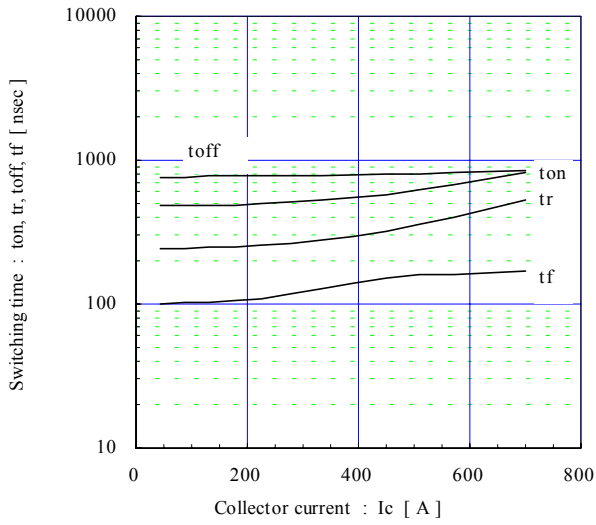

Switching time vs. Collector current (typ.)  
 $V_{cc}=900V, V_{GE}=\pm 15V, R_g=1.1\Omega, T_j=125^\circ C$

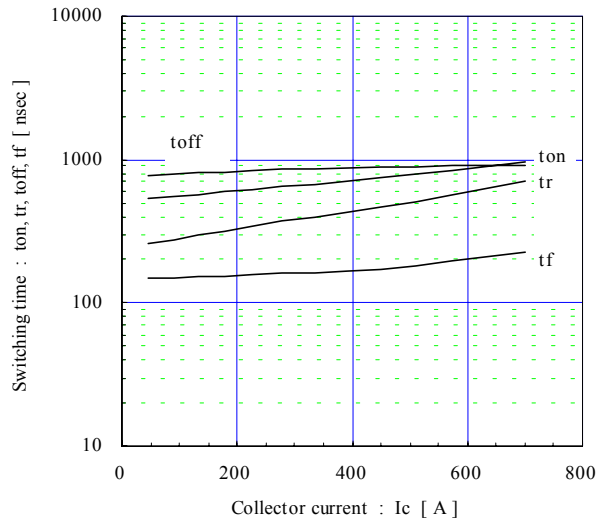

Switching time vs. Gate resistance (typ.)  
 $V_{cc}=900V, I_c=450A, V_{GE}=\pm 15V, T_j=25^\circ C$

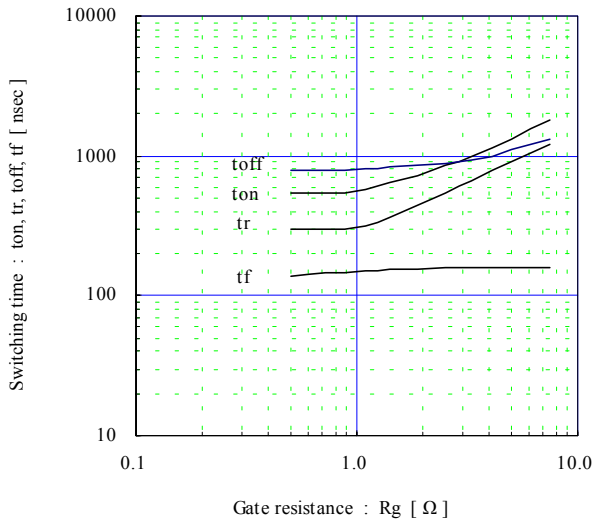

Switching loss vs. Collector current (typ.)  
 $V_{cc}=900V, V_{GE}=\pm 15V, R_g=1.1\Omega$

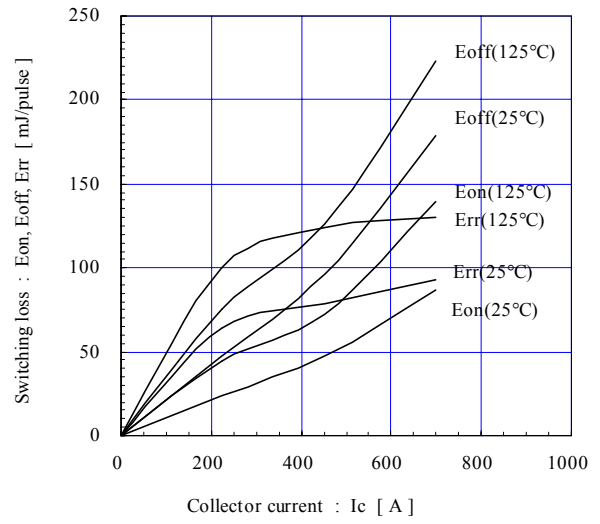

Switching loss vs. Gate resistance (typ.)  
 $V_{cc}=900V, I_c=450A, V_{GE}=\pm 15V, T_j=125^\circ C$

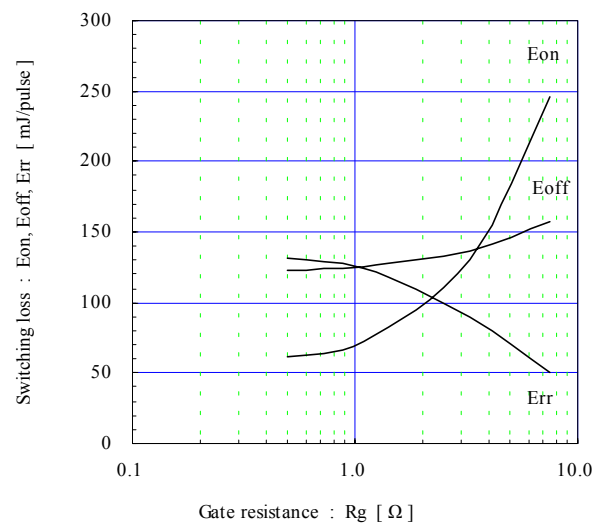

Reverse bias safe operating area (max.)  
 $+V_{GE}=15V, -V_{GE} \le 15V, R_g \ge 1.1\Omega, T_j \le 125^\circ C$   
 Stray inductance  $\le 100nH$

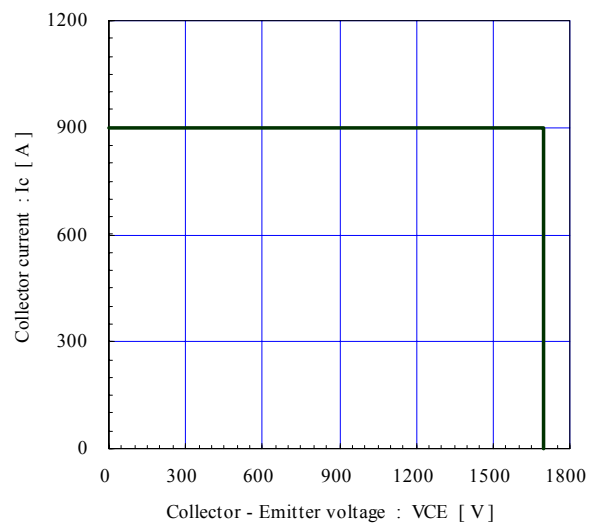

Forward current vs. Forward on voltage (typ.)  
chip

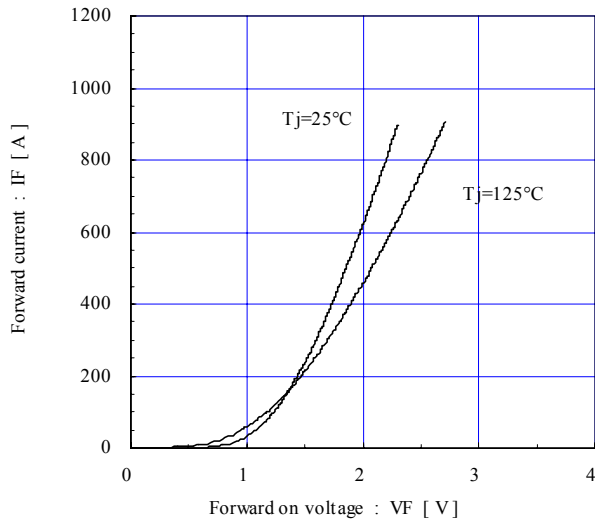

Reverse recovery characteristics (typ.)  
 $V_{cc}=900\text{V}$ ,  $V_{GE}=\pm 15\text{V}$ ,  $R_g=1.1\Omega$

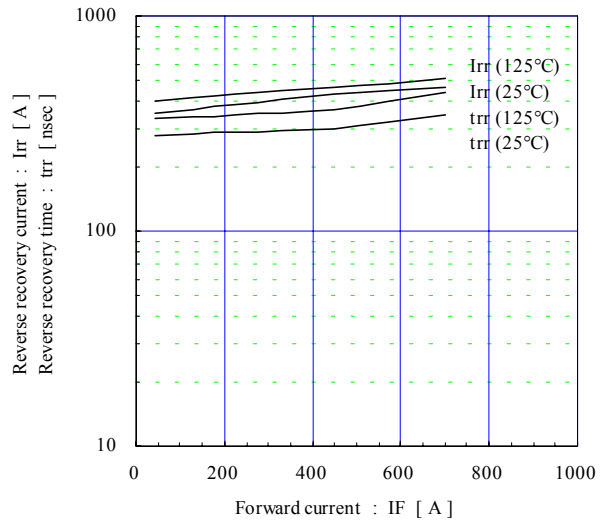

Transient thermal resistance (max.)

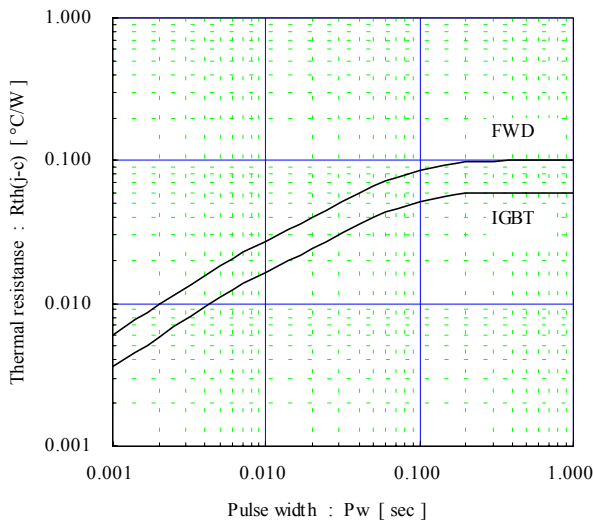

Temperature characteristic (typ.)

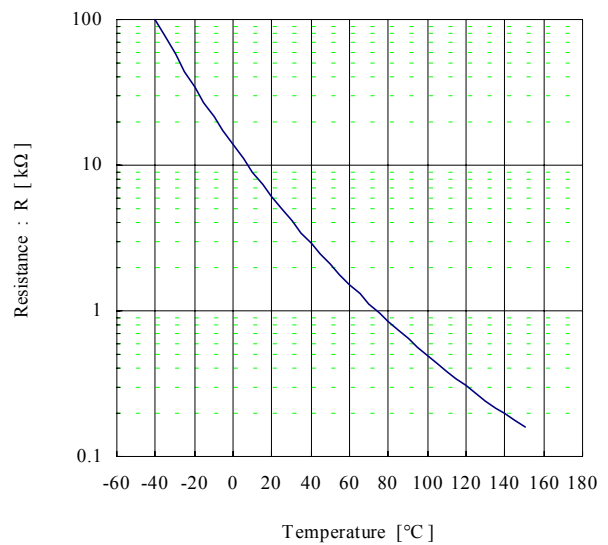

■ Outline Drawings, mm

M629

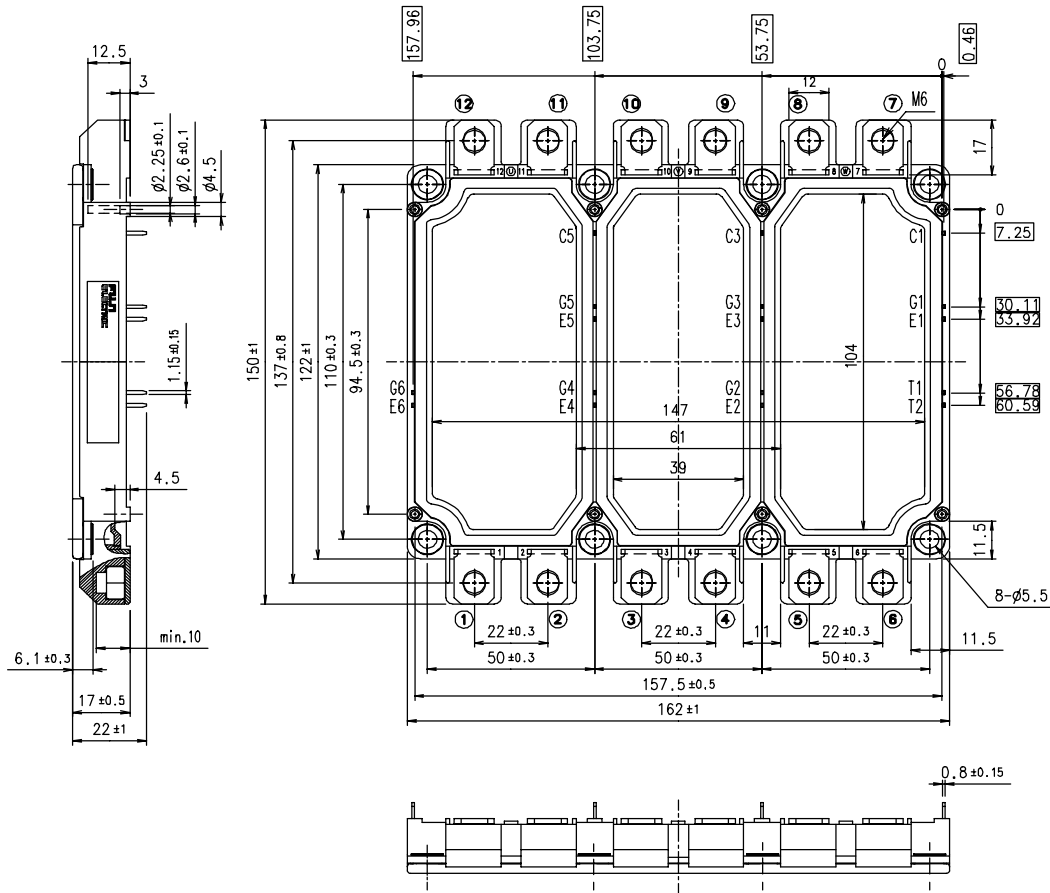

注) □ shows theoretical dimension and tolerance is  $\pm 0.5$  .

■ Equivalent Circuit Schematic

