

# SPECIFICATION

Device Name : IGBT Module

Type Name : 6MB150S-140

Spec. No. : MS5F 4723

Fuji Electric Co., Ltd.  
Matsumoto Factory

This material and the information herein is the property of Fuji Electric Co. Ltd. They shall be neither reproduced, copied, lent, or disclosed in any way whatsoever for the use of any third party nor used for the manufacturing purposes without the express written consent of Fuji Electric Co., Ltd.

|         | DATE           | NAME         | APPROVED    | Fuji Electric Co., Ltd. |           |       |
|---------|----------------|--------------|-------------|-------------------------|-----------|-------|
| DRAWN   | Nov - 10 - '99 | T. Kobayashi | T. Miyasaka | DWG. NO.                | MS5F 4723 | 1 / 8 |
| CHECKED | Nov - 10 - '99 | D. M. H. A.  |             |                         |           |       |
|         |                |              |             |                         |           |       |

# Revised Records

| Date         | Classi-<br>fication | Ind. | Content | Applied<br>date | Drawn | Checked     | Approved    |
|--------------|---------------------|------|---------|-----------------|-------|-------------|-------------|
| Nov, -10-'49 | enactment           | —    | —       | Issued<br>date  | —     | S. M. A. G. | T. Miyasaka |
|              |                     |      |         |                 |       |             |             |
|              |                     |      |         |                 |       |             |             |
|              |                     |      |         |                 |       |             |             |
|              |                     |      |         |                 |       |             |             |
|              |                     |      |         |                 |       |             |             |
|              |                     |      |         |                 |       |             |             |
|              |                     |      |         |                 |       |             |             |
|              |                     |      |         |                 |       |             |             |
|              |                     |      |         |                 |       |             |             |
|              |                     |      |         |                 |       |             |             |
|              |                     |      |         |                 |       |             |             |
|              |                     |      |         |                 |       |             |             |
|              |                     |      |         |                 |       |             |             |
|              |                     |      |         |                 |       |             |             |
|              |                     |      |         |                 |       |             |             |
|              |                     |      |         |                 |       |             |             |
|              |                     |      |         |                 |       |             |             |
|              |                     |      |         |                 |       |             |             |
|              |                     |      |         |                 |       |             |             |
|              |                     |      |         |                 |       |             |             |

This material and the information herein is the property of Fuji Electric Co., Ltd. They shall be neither reproduced, copied, lent, or disclosed in any way whatsoever for the use of any third party, nor used for the manufacturing purposes without the express written consent of Fuji Electric Co., Ltd.

**Fuji Electric Co., Ltd.**

DWG. NO.

MS 5 F 4 7 2 3

2 / 8

|  |  |
|--|--|
|  |  |
|  |  |
|  |  |
|  |  |

6MBI50S-140

1. Outline Drawing (Unit : mm)

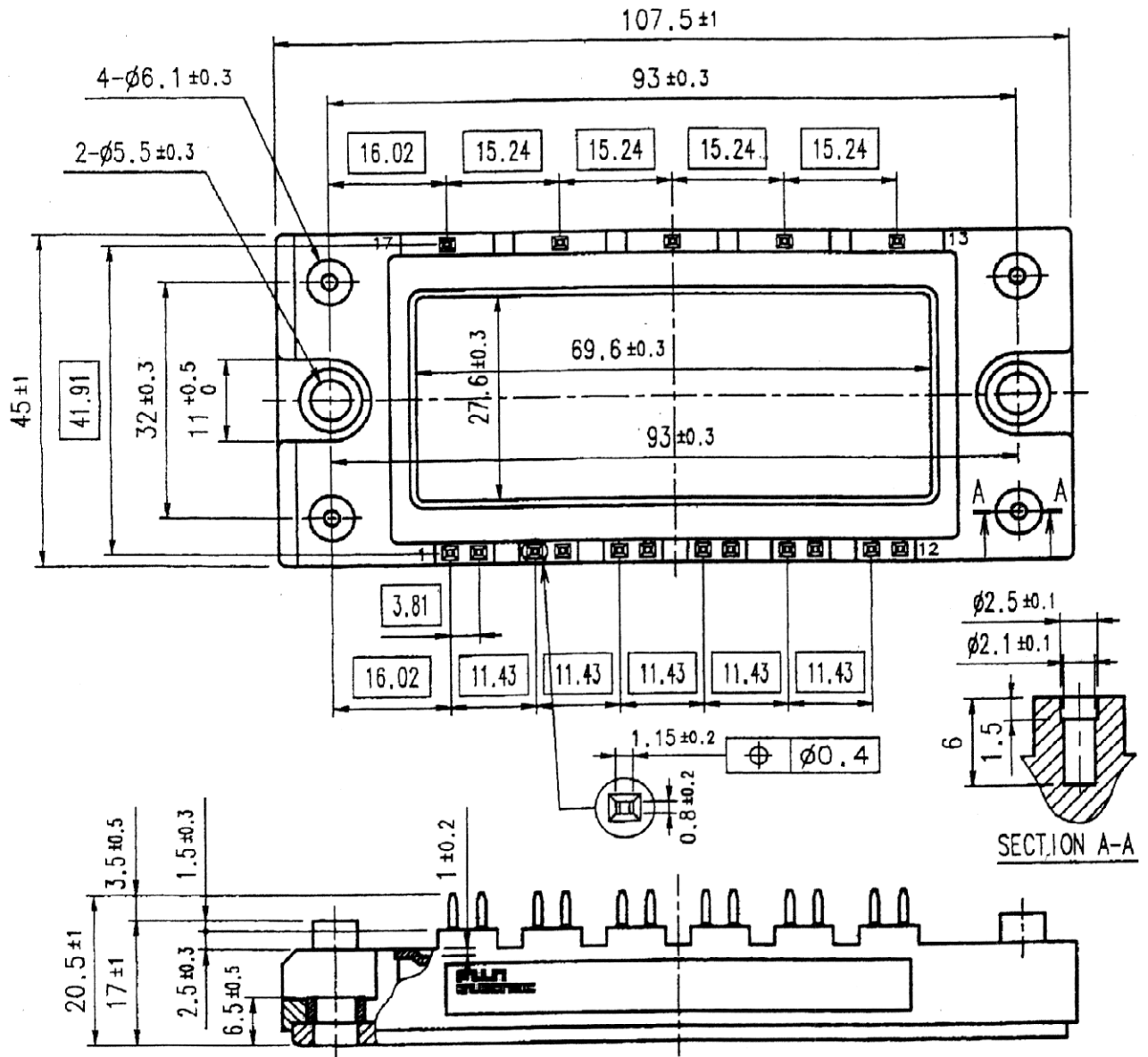

□ shows theoretical dimension.

2. Equivalent circuit

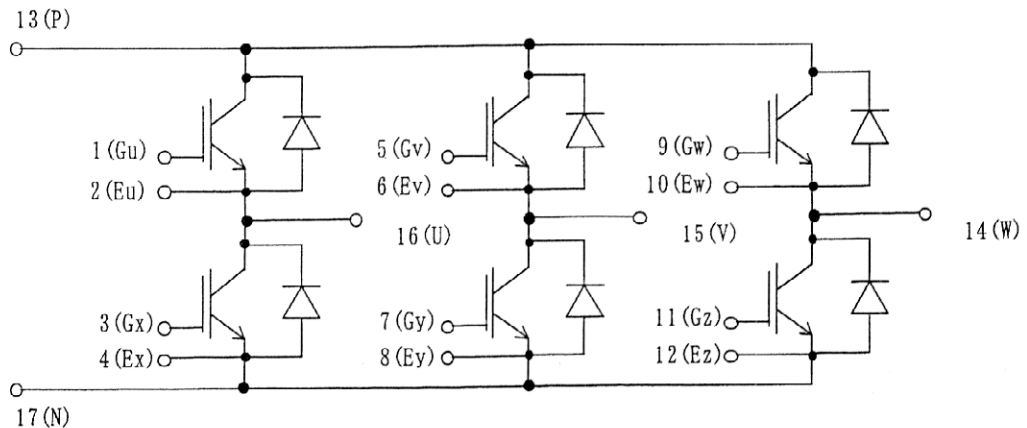

This material and the information herein is the property of Fuji Electric Co., Ltd. They shall be neither reproduced, copied, lent, or disclosed in any way whatsoever for the use of any third party nor used for the manufacturing purposes without the express written consent of Fuji Electric Co., Ltd.

3. Absolute Maximum Ratings ( at Tc= 25°C unless otherwise specified )

| Items                                 | Symbols              | Conditions | Maximum Ratings      |           | Units |
|---------------------------------------|----------------------|------------|----------------------|-----------|-------|
|                                       |                      |            |                      |           |       |
| Collector-Emitter voltage             | V <sub>CE</sub>      |            |                      | 1400      | V     |
| Gate-Emitter voltage                  | V <sub>GE</sub>      |            |                      | ±20       | V     |
| Collector current                     | I <sub>c</sub>       | Continuous | T <sub>c</sub> =25°C | 75        | A     |
|                                       |                      |            | T <sub>c</sub> =75°C | 50        |       |
|                                       | I <sub>c</sub> pulse | 1ms        | T <sub>c</sub> =25°C | 150       |       |
|                                       |                      |            | T <sub>c</sub> =75°C | 100       |       |
|                                       | -I <sub>c</sub>      |            |                      | 50        |       |
| -I <sub>c</sub> pulse                 | 1ms                  |            | 100                  |           |       |
| Collector Power Dissipation           | P <sub>c</sub>       | 1 device   |                      | 360       | W     |
| Junction temperature                  | T <sub>j</sub>       |            |                      | 150       | °C    |
| Storage temperature                   | T <sub>stg</sub>     |            |                      | -40~ +125 | °C    |
| Isolation voltage <sup>(*1)</sup>     | Viso                 | AC : 1min. |                      | 2500      | V     |
| Mounting Screw Torque <sup>(*2)</sup> |                      |            |                      | 3.5       | N·m   |

(\*1) All terminals should be connected together when isolation test will be done.

(\*2) Recommendable Value : 2.5~3.5 N·m (M5)

4. Electrical characteristics ( at Tj= 25°C unless otherwise specified)

| Items                                | Symbols              | Conditions                                      | Characteristics         |      |      | Units |
|--------------------------------------|----------------------|---|-------------------------|------|------|-------|
|                                      |                      |   | min.                    | typ. | Max. |       |
| Zero gate voltage Collector current  | ICES                 | V <sub>GE</sub> = 0 V, V <sub>CE</sub> = 1400 V |                         |      | 1.0  | mA    |
| Gate-Emitter leakage current         | IGES                 | V <sub>CE</sub> = 0 V, V <sub>GE</sub> = ±20 V  |                         |      | 200  | nA    |
| Gate-Emitter threshold voltage       | V <sub>GE(th)</sub>  | V <sub>CE</sub> = 20 V, I <sub>c</sub> = 50 mA  | 5.5                     | 7.2  | 8.5  | V     |
| Collector-Emitter saturation voltage | V <sub>CE(sat)</sub> | V <sub>GE</sub> = 15 V, T <sub>j</sub> = 25 °C  |                         | 2.4  | 2.75 | V     |
|                                      |                      | I <sub>c</sub> = 50 A, T <sub>j</sub> = 125 °C  |                         | 3.0  |      |       |
| Input capacitance                    | C <sub>ies</sub>     | V <sub>GE</sub> = 0 V                           |                         | 6000 |      | pF    |
| Output capacitance                   | C <sub>oes</sub>     | V <sub>CE</sub> = 10 V                          |                         | 1250 |      |       |
| Reverse transfer capacitance         | C <sub>res</sub>     | f = 1 MHz                                       |                         | 1100 |      |       |
| Turn-on time                         | t <sub>on</sub>      | V <sub>cc</sub> = 800 V                         |                         | 0.35 | 1.2  | μs    |
|                                      | t <sub>r</sub>       | I <sub>c</sub> = 50 A                           |                         | 0.25 | 0.6  |       |
|                                      | t <sub>r(i)</sub>    | V <sub>GE</sub> = ±15 V                         |                         | 0.1  |      |       |
| Turn-off time                        | t <sub>off</sub>     | R <sub>G</sub> = 24 Ω                           |                         | 0.45 | 1.0  | μs    |
|                                      | t <sub>f</sub>       |   |                         | 0.08 | 0.3  |       |
| Forward on voltage                   | V <sub>F</sub>       | I <sub>F</sub> = 50 A                           | T <sub>j</sub> = 25 °C  | 2.6  | 3.4  | V     |
|                                      |                      |   | T <sub>j</sub> = 125 °C | 2.2  |      |       |
| Reverse recovery time                | t <sub>rr</sub>      | I <sub>F</sub> = 50 A                           |                         |      | 0.35 | μs    |

5. Thermal resistance characteristics

| Items                         | Symbols              | Conditions                | Characteristics |      |      | Units |
|-------------------------------|----------------------|---------------------------|-----------------|------|------|-------|
|                               |                      |                           | min.            | typ. | Max. |       |
| Thermal resistance (1 device) | R <sub>th(j-c)</sub> | IGBT                      |                 |      | 0.35 | °C/W  |
|                               |                      | FWD                       |                 |      | 0.75 |       |
| Contact Thermal resistance    | R <sub>th(c-f)</sub> | with Thermal Compound (※) |                 | 0.05 |      |       |

※ This is the value which is defined mounting on the additional cooling fin

6. Indication on module (モジュール表示)

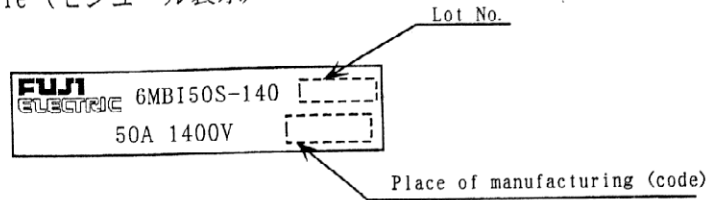

7. Applicable category (適用範囲)

This specification is applied to IGBT Module named 6MBI50S-140 .  
 本納入仕様書は IGBTモジュール 6MBI50S-140 に適用する。

8. Storage and transportation notes (保管・運搬上の注意事項)

- The module should be stored at a standard temperature of 5 to 35°C and humidity of 45 to 75% .  
 常温・常湿保存が望ましい。(5~35°C, 45~75%)
- Store modules in a place with few temperature changes in order to avoid condensation on the module surface.  
 急激な温度変化のなきこと。(モジュール表面が結露しないこと)
- Avoid exposure to corrosive gases and dust.  
 腐蝕性ガスの発生場所, 塵埃の多い場所は避けること。
- Avoid excessive external force on the module.  
 製品に荷重がかからないように 十分注意すること。
- Store modules with unprocessed terminals.  
 モジュールの端子は未加工の状態 で保管すること。
- Do not drop or otherwise shock the modules when transporting.  
 製品の運搬時に衝撃を与えたり, 落下させたりしないこと。

9. Definitions of switching time (スイッチング時間の定義)

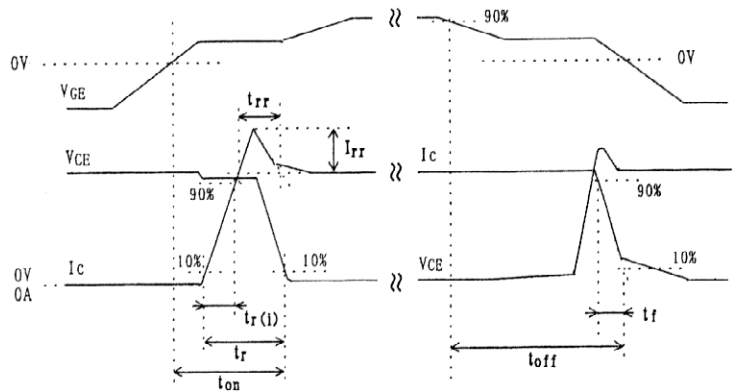
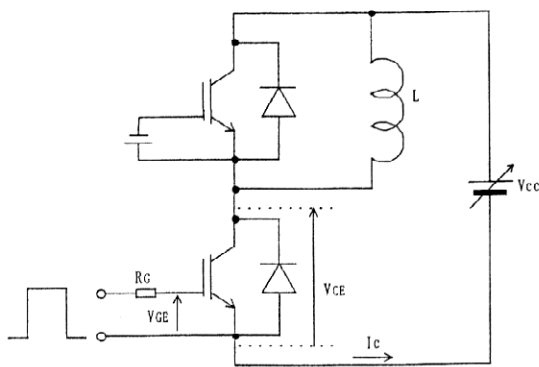

This material and the information herein is the property of Fuji Electric Co., Ltd. They shall be neither reproduced, copied, lent, or disclosed in any way whatsoever for the use of any third party nor used for the manufacturing purposes without the express written consent of Fuji Electric Co., Ltd.

This material and the information herein is the property of Fuji Electric Co. Ltd. They shall be neither reproduced, copied, lent, or disclosed in any way whatsoever for the use of any third party, nor used for the manufacturing purposes without the express written consent of Fuji Electric Co. Ltd.

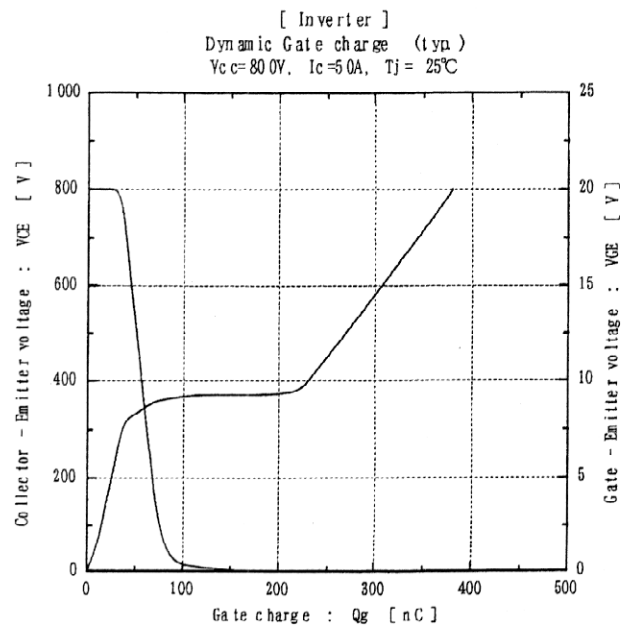
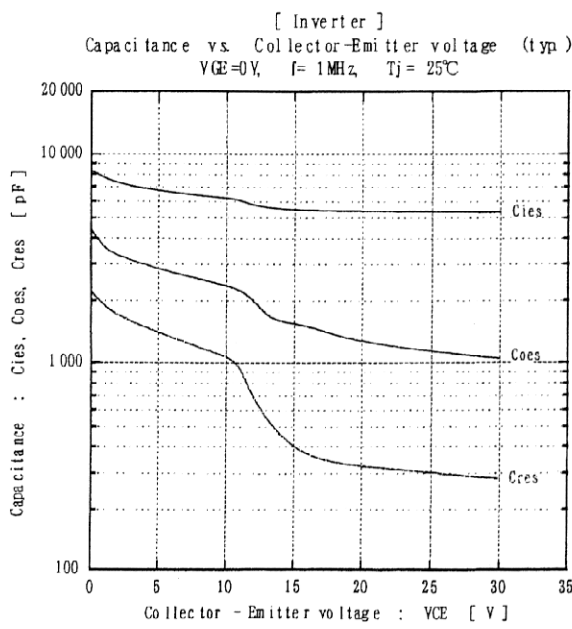
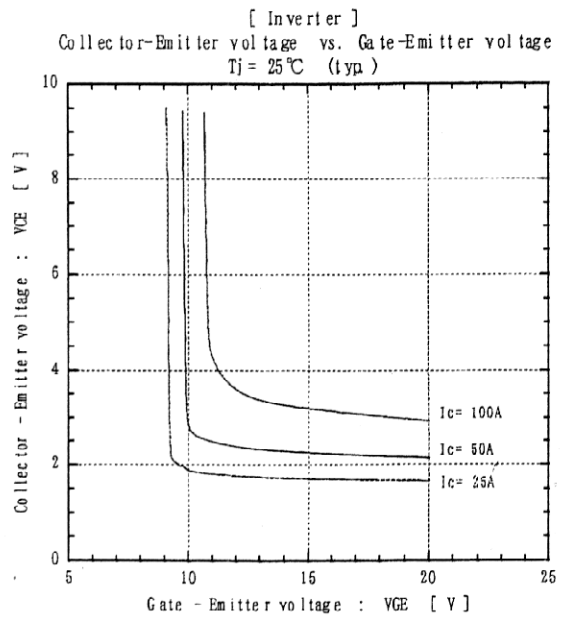
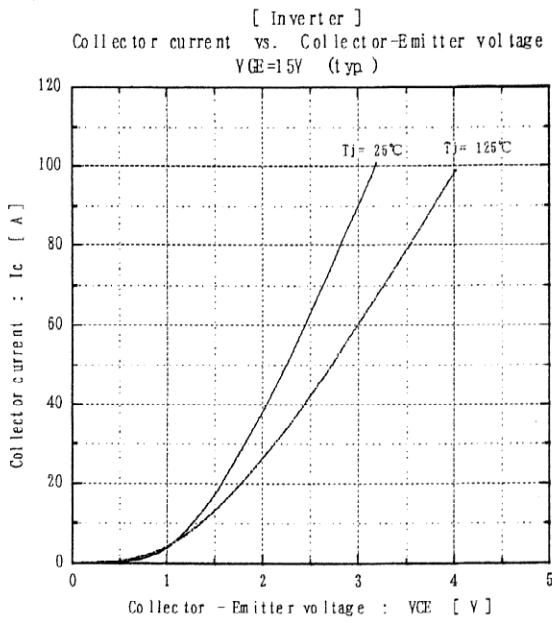
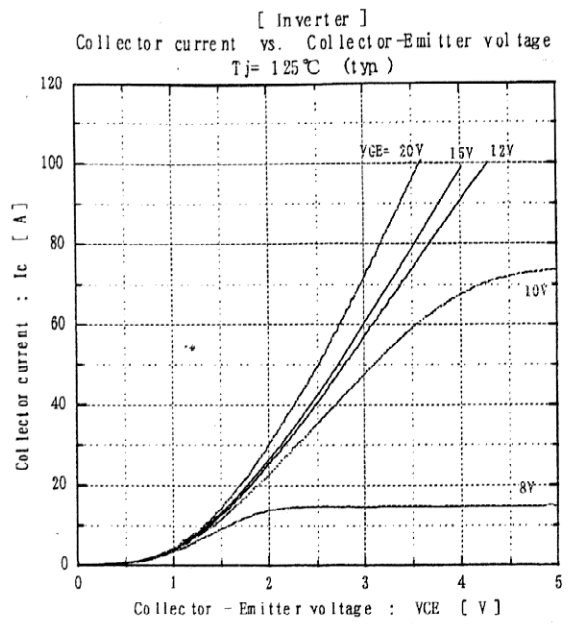
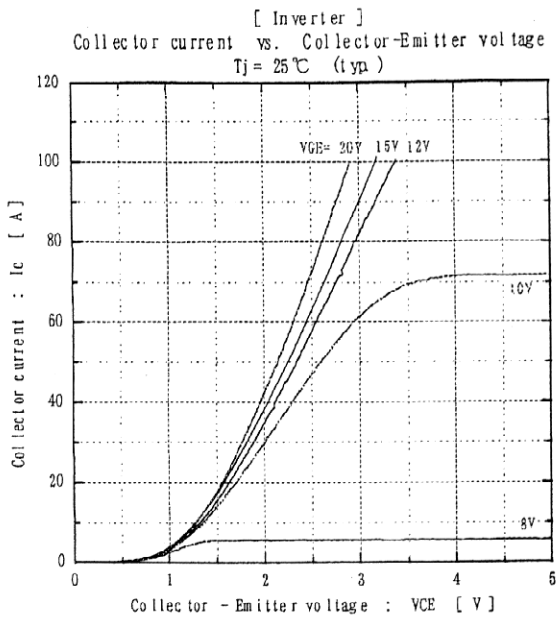

Fuji Electric Co., Ltd.

DWG. NO.

MS 5 F 4 7 2 3

6/8

H04-004-03

This material and the information herein is the property of Fuji Electric Co., Ltd. They shall be neither reproduced, copied, lent, or disclosed in any way whatsoever for the use of any third party nor used for the manufacturing purposes without the express written consent of Fuji Electric Co., Ltd.

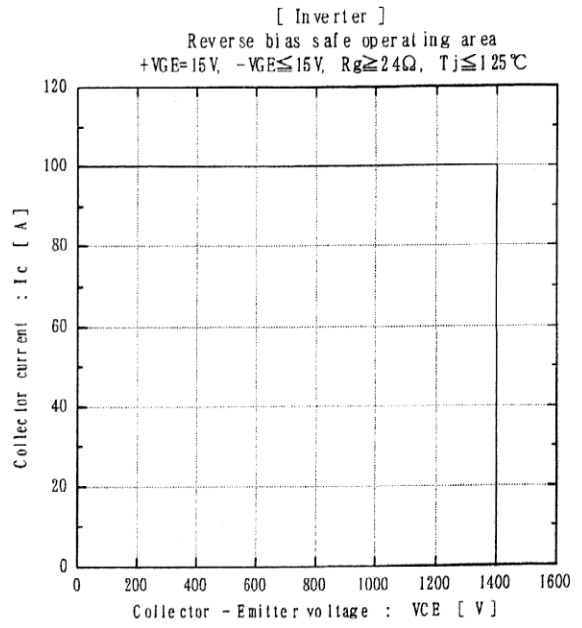
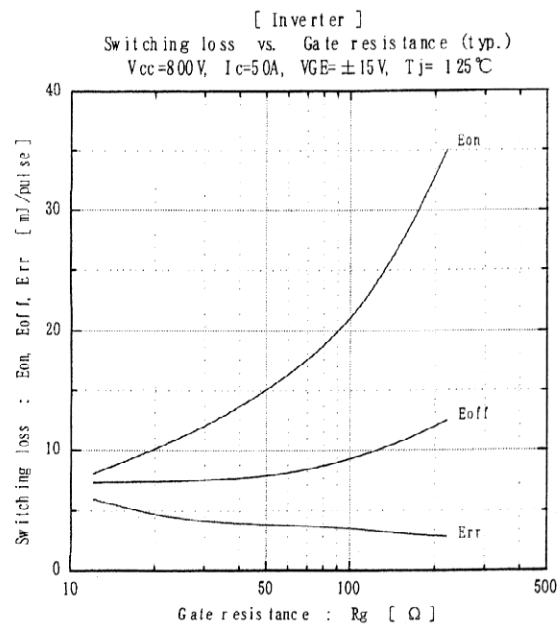
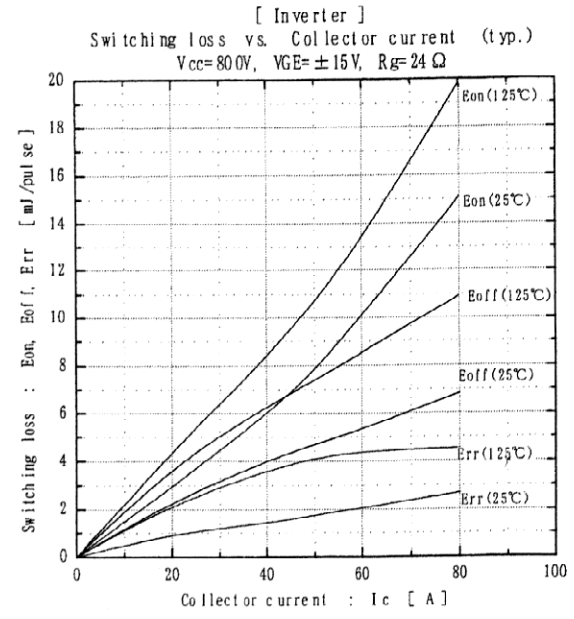
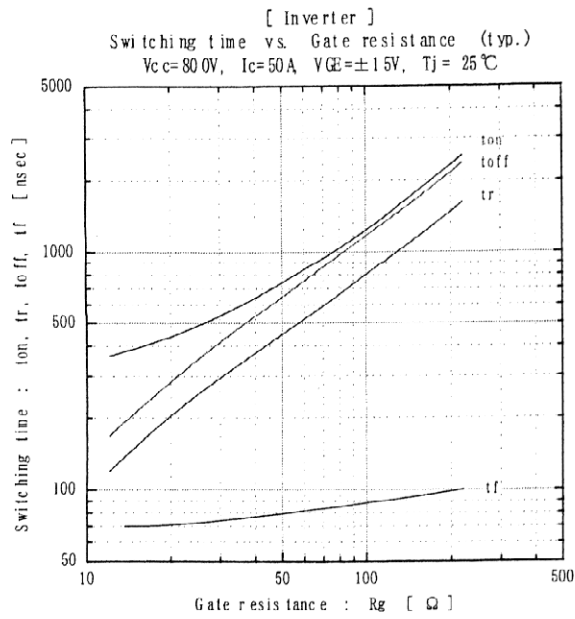
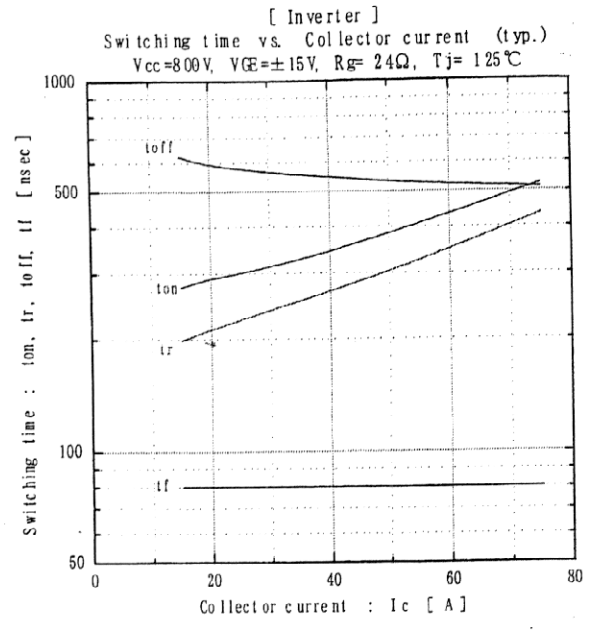
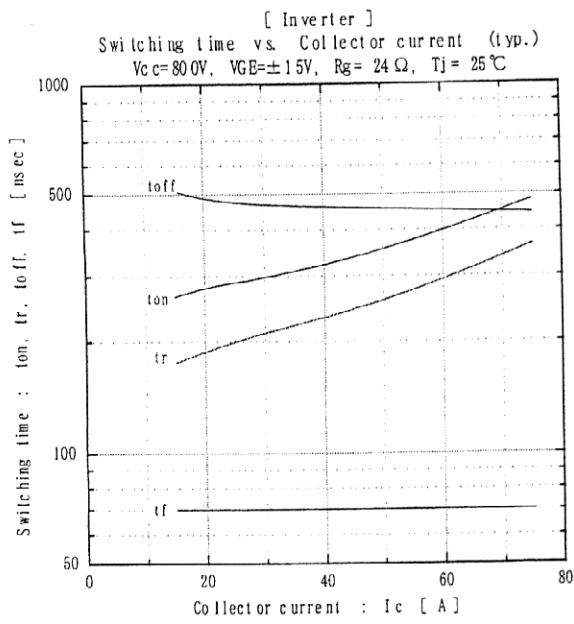

Fuji Electric Co., Ltd.

DWG. NO.

MS5F4723

7/8

H04-004-03

Forward current vs. Forward on voltage (typ.)

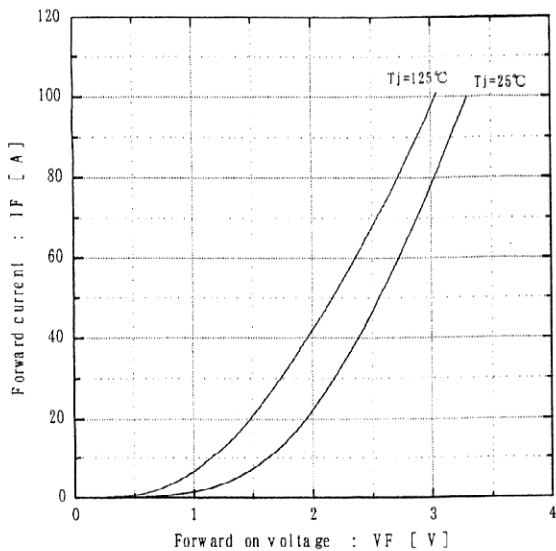

Reverse recovery characteristics (typ.)

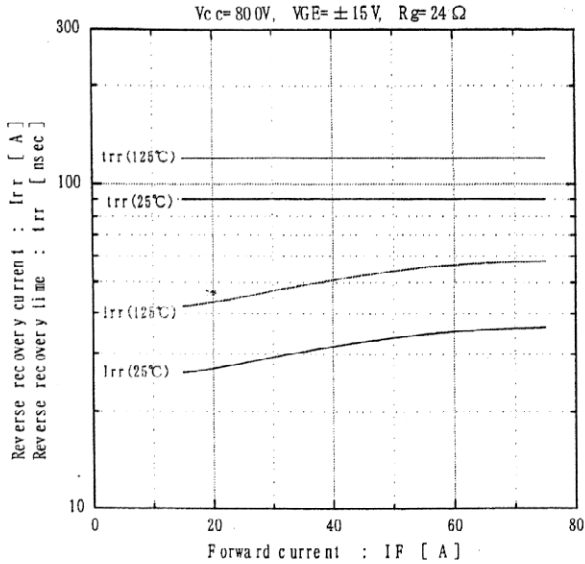

Transient thermal resistance

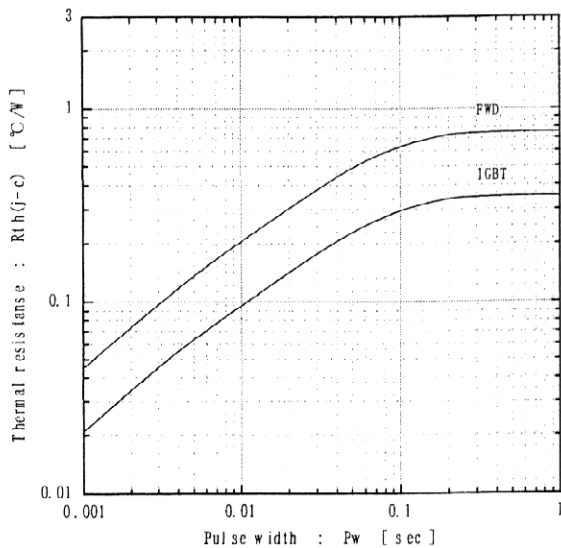

This material and the information herein is the property of Fuji Electric Co., Ltd. They shall be neither reproduced, copied, lent, or disclosed in any way whatsoever for the use of any third party nor used for the manufacturing purposes without the express written consent of Fuji Electric Co., Ltd.