

SPECIFICATION

Device Name : IGBT - IPM
 Type Name : 6MBP150RTJ060
 Spec. No. : MS6M 0677

This material and the information herein is the property of Fuji Electric Co., Ltd. They shall be neither reproduced, copied, lent, or disclosed in any way whatsoever for the use of any third party nor used for the manufacturing purposes without the express written consent of Fuji Electric Co., Ltd.

Fuji Electric Co., Ltd.
Matsumoto Factory

	DATE	NAME	APPROVED	Fuji Electric Co., Ltd.			
DRAWN	Jan.- 29 -'03	N.Matsuda	T.Fujihira	DWG.NO.	MS6M 0677	1 /	
CHECKED	Jan.- 29 -'03	Nishiura				22	a
	Jan.-29 -'03	K.Yamada					

Revised Records

Date	Classification	Ind.	Content	Applied date	Drawn	Checked	Approved
Jan.-29-'03	enactment	—	—	Issued date	N.Matsuda	A.Nishiura K.Yamada	T.Fujihira
May.-19-'03	Revision	a	Reliability Test Items		N.Matsuda	T.Miyasaka K.Yamada	T.Fujihira

This material and the information herein is the property of Fuji Electric Co., Ltd. They shall be neither reproduced, copied, lent, or disclosed in any way whatsoever for the use of any third party nor used for the manufacturing purposes without the express written consent of Fuji Electric Co., Ltd.

Fuji Electric Co.,Ltd.

DWG.NO.

MS6M 0677

2 / 22

	a

1. Package Outline Drawings

(a)

Package type : P621

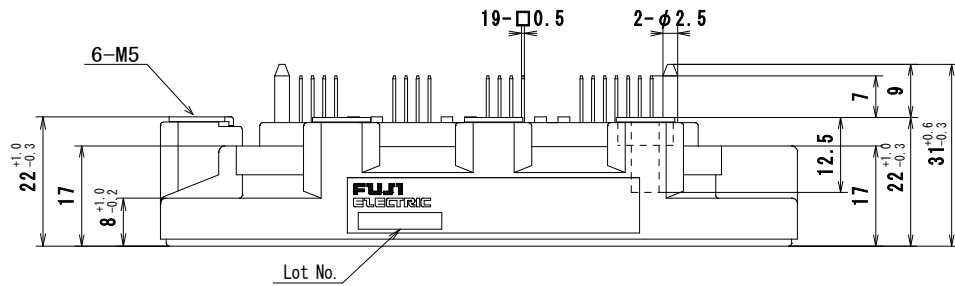
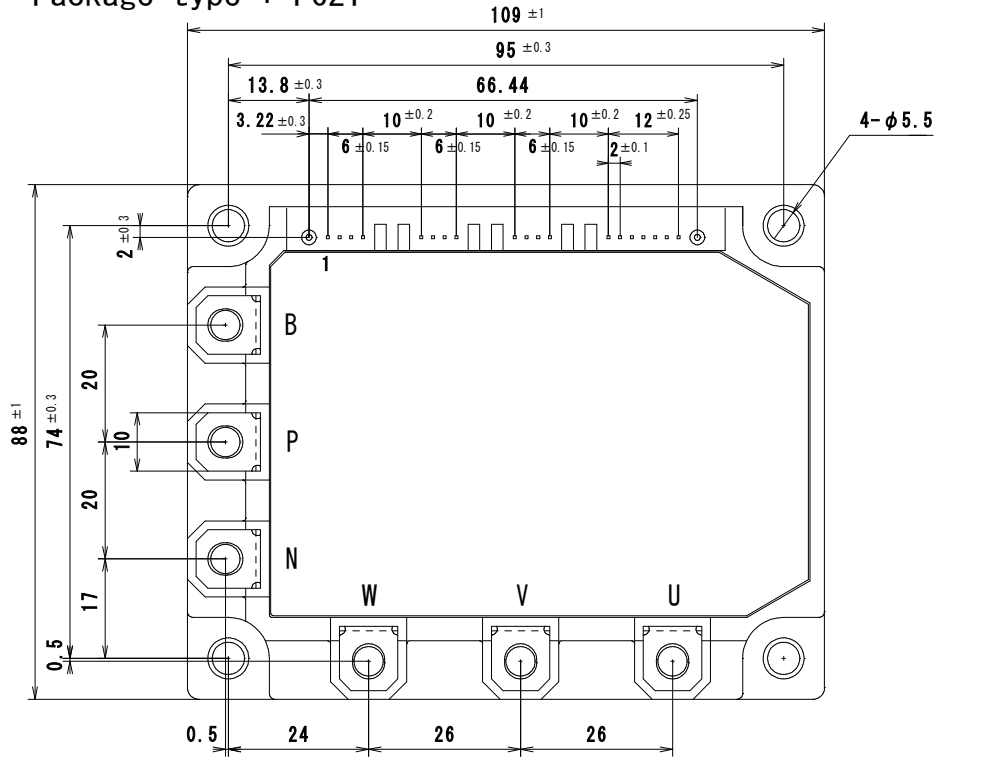

Indication of Lot No.

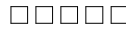

Odered No. in monthly
 Manufactured month
 (Jan. ~Sep. : 1~9, Oct. : 0, Nov. : N, Dec. : D)
 Last digit of manufactured year

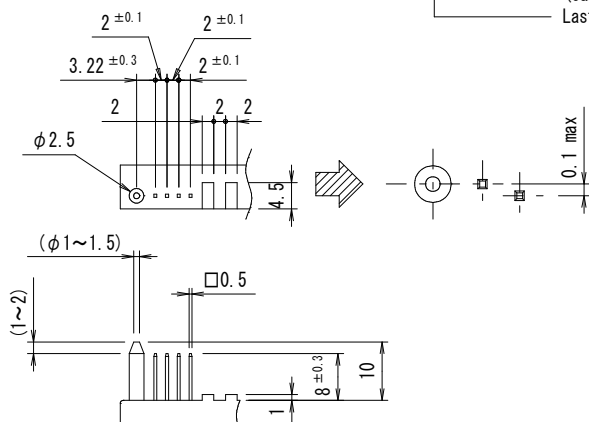

Details of control terminals

Dimensions in mm

Fuji Electric Co.,Ltd.

DWG.NO.

MS6M 0677

3 / 22

a

This material and the information herein is the property of Fuji Electric Co.,Ltd. They shall be neither reproduced, copied, lent, or disclosed in any way whatsoever for the use of any third party nor used for the manufacturing purposes without the express written consent of Fuji Electric Co., Ltd.

2. Pin Descriptions

Main circuit

Symbol	Description
P	Positive input supply voltage.
U	Output (U).
V	Output (V).
W	Output (W).
N	Negative input supply voltage.
B	No contact.

Control circuit

No	Symbol	Description
①	GNDU	High side ground (U).
②	ALMU	Alarm signal output (U).
③	VinU	Logic input for IGBT gate drive (U).
④	VccU	High side supply voltage (U).
⑤	GNDV	High side ground (V).
⑥	ALMV	Alarm signal output (V).
⑦	VinV	Logic input for IGBT gate drive (V).
⑧	VccV	High side supply voltage (V).
⑨	GNDW	High side ground (W).
⑩	ALMW	Alarm signal output (W).
⑪	VinW	Logic input for IGBT gate drive (W).
⑫	VccW	High side supply voltage (W).
⑬	GND	Low side ground.
⑭	Vcc	Low side supply voltage.
⑮	VinDB	No contact.
⑯	VinX	Logic input for IGBT gate drive (X).
⑰	VinY	Logic input for IGBT gate drive (Y).
⑱	VinZ	Logic input for IGBT gate drive (Z).
⑲	ALM	Low side alarm signal output.

This material and the information herein is the property of Fuji Electric Co., Ltd. They shall be neither reproduced, copied, lent, or disclosed in any way whatsoever for the use of any third party nor used for the manufacturing purposes without the express written consent of Fuji Electric Co., Ltd.

3. Block Diagram

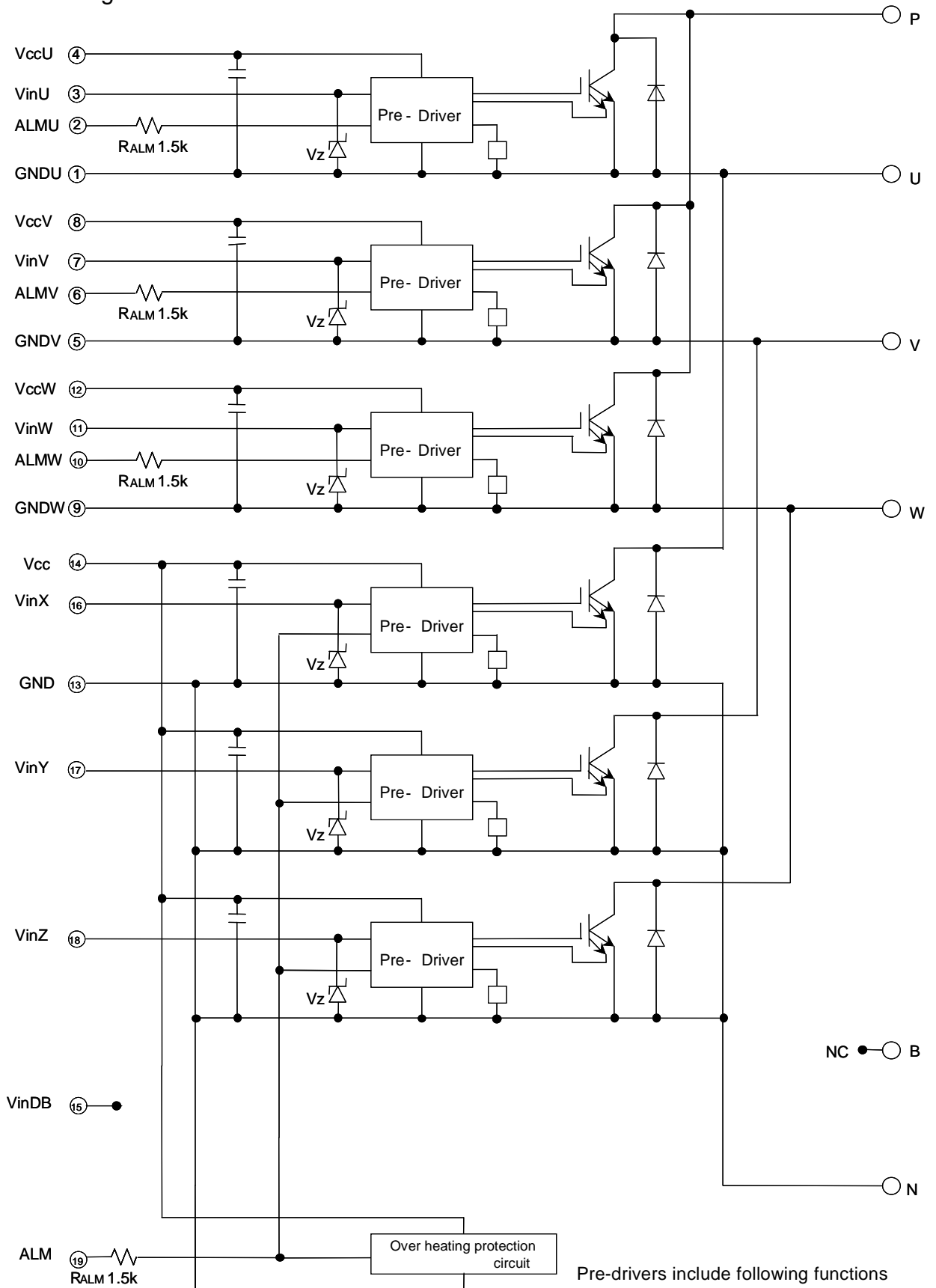

- Pre-drivers include following functions
1. Amplifier for driver
 2. Short circuit protection
 3. Under voltage lockout circuit
 4. Over current protection
 5. IGBT chip over heating protection

This material and the information herein is the property of Fuji Electric Co., Ltd. They shall be neither reproduced, copied, lent, or disclosed in any way whatsoever for the use of any third party nor used for the manufacturing purposes without the express written consent of Fuji Electric Co., Ltd.

4. Absolute Maximum Ratings

Tc=25°C unless otherwise specified.

Items		Symbol	Min.	Max.	Units	
Bus Voltage (between terminal P and N)	DC	V _{DC}	0	450	V	
	Surge	V _{DC(surge)}	0	500	V	
	Short operating	V _{sc}	200	400	V	
Collector-Emitter Voltage *1		V _{ces}	0	600	V	
Inverter	Collector Current	DC	I _c	-	150	A
		1ms	I _{cp}	-	300	A
		Duty=68.2% *2	-I _c	-	150	A
	Collector Power Dissipation	One transistor *3	P _c	-	431	W
Supply Voltage of Pre-Driver *4		V _{cc}	-0.5	20	V	
Input Signal Voltage *5		V _{in}	-0.5	V _{cc} +0.5	V	
Input Signal Current		I _{in}	-	3	mA	
Alarm Signal Voltage *6		V _{ALM}	-0.5	V _{cc}	V	
Alarm Signal Current *7		I _{ALM}	-	20	mA	
Junction Temperature		T _j	-	150	°C	
Operating Case Temperature		T _{opr}	-20	100	°C	
Storage Temperature		T _{stg}	-40	125	°C	
Isolating Voltage (Terminal to base, 50/60Hz sine wave 1min.)		V _{iso}	-	AC2500	V	
Screw Torque	Terminal (M5)	-	-	3.5	Nm	
	Mounting (M5)					

Note

- *1 : V_{ces} shall be applied to the input voltage between terminal P and U or V or W, N and U or V or W .
- *2 : $125^{\circ}\text{C}/\text{FWD } R_{th(j-c)}/(I_c \times V_F \text{ MAX})=125/0.47/(150 \times 2.6) \times 100=68.2\%$
- *3 : $P_c=125^{\circ}\text{C}/\text{IGBT } R_{th(j-c)}=125/0.29=431\text{W}$ [Inverter]
- *4 : V_{CC} shall be applied to the input voltage between terminal No.4 and 1, 8 and 5, 12 and 9, 14 and 13.
- *5 : V_{i n} shall be applied to the input voltage between terminal No.3 and 1, 7 and 5, 11 and 9, 16,17,18 and 13.
- *6 : V_{A L M} shall be applied to the voltage between terminal No.2 and 1, No6 and 5, No10 and 9, No.19 and 13.
- *7 : I_{A L M} shall be applied to the input current to terminal No.2,6,10 and 19.

This material and the information herein is the property of Fuji Electric Co.,Ltd. They shall be neither reproduced, copied, lent, or disclosed in any way whatsoever for the use of any third party nor used for the manufacturing purposes without the express written consent of Fuji Electric Co., Ltd.

5. Electrical Characteristics

$T_j=25^{\circ}\text{C}$, $V_{CC}=15\text{V}$ unless otherwise specified.

5.1 Main circuit

Item	Symbol	Conditions	Min.	Typ.	Max.	Units	
Inverter	Collector Current at off signal input	I_{CES}	$V_{CE} = 600\text{V}$ V_{in} terminal open.	-	-	1.0	mA
	Collector-Emitter saturation voltage	$V_{CE(sat)}$	Terminal	-	-	2.3	V
			Chip	-	1.8	-	V
Forward voltage of FWD	VF	$-I_C = 150\text{A}$	Terminal	-	-	2.6	V
			Chip	-	1.6	-	V
Turn-on time	t_{on}	$V_{DC}=300\text{V}$, $T_j=125^{\circ}\text{C}$	1.2	-	-	μs	
Turn-off time	t_{off}	$I_C=150\text{A}$ Fig.1, Fig.6	-	-	3.6		
Reverse recovery time	t_{rr}	$V_{DC}=300\text{V}$ $I_F=150\text{A}$ Fig.1, Fig.6	-	-	0.3		
Maximum Avalanche Energy (A non-repetition)	PAV	internal wiring inductance=50nH Main circuit wiring inductance=54nH	170	-	-	mJ	

5.2 Control circuit

Item	Symbol	Conditions	Min.	Typ.	Max.	Units
Supply current of P-side pre-driver (one unit)	I_{CCP}	Switching Frequency : 0~15kHz	-	-	18	mA
Supply current of N-side pre-driver	I_{CCN}	$T_c=-20\sim 125^{\circ}\text{C}$ Fig.7	-	-	65	mA
Input signal threshold voltage	$V_{in(th)}$	ON	1.00	1.35	1.70	V
		OFF	1.25	1.60	1.95	
Input Zener Voltage	V_Z	$R_{in}=20\text{k}\Omega$	-	8.0	-	V
Alarm Signal Hold Time	tALM	$T_c=-20^{\circ}\text{C}$ Fig.2	1.1	-	-	ms
		$T_c=25^{\circ}\text{C}$ Fig.2	-	2.0	-	
		$T_c=125^{\circ}\text{C}$ Fig.2	-	-	4.0	
Current Limit Resistor	RALM	Alarm terminal	1425	1500	1575	Ω

This material and the information herein is the property of Fuji Electric Co., Ltd. They shall be neither reproduced, copied, lent, or disclosed in any way whatsoever for the use of any third party nor used for the manufacturing purposes without the express written consent of Fuji Electric Co., Ltd.

5.3 Protection Section (Vcc=15V)

Item	Symbol	Conditions	Min.	Typ.	Max.	Units
Over Current Protection Level of Inverter circuit	loc	Tj=125°C	225	-	-	A
Over Current Protection Delay time	tdoc	Tj=125°C	-	5	-	μs
SC Protection Delay time	tsc	Tj=125°C Fig.4	-	-	8	μs
IGBT Chips Over Heating Protection Temperature Level	TjOH	Surface of IGBT Chips	150	-	-	°C
Over Heating Protection Hysteresis	TjH		-	20	-	°C
Over Heating Protection Protection Temperature Level	TcOH	VDC=0V, Ic=0A Case Temperature	110	-	125	°C
Over Heating Protection Hysteresis	TcH		-	20	-	°C
Under Voltage Protection Level	VUV		11.0	-	12.5	V
Under Voltage Protection Hysteresis	VH		0.2	0.5	-	

6. Thermal Characteristics (Tc=25°C)

Item		Symbol	Min.	Typ.	Max.	Units
Junction to Case Thermal Resistance *8	Inverter IGBT	Rth(j-c)	-	-	0.29	°C/W
	FWD	Rth(j-c)	-	-	0.47	
Case to Fin Thermal Resistance with Compound		Rth(c-f)	-	0.05	-	

*8 : (For 1device , Case is under the device)

7. Noise Immunity (Vdc=300V, Vcc=15V, Test Circuit Fig 5.)

Item	Conditions	Min.	Typ.	Max.	Units
Common mode rectangular noise	Pulse width 1us,polarity ±,10 minuets Judge : no over-current, no miss operating	±2.0	-	-	kV
Common mode lightning surge	Rise time 1.2us,Fall time 50μs Interval 20s,10 times Judge : no over-current, no miss operating	±5.0	-	-	kV

8. Recommended Operating Conditions

Item	Symbol	Min.	Typ.	Max.	Units
DC Bus Voltage	VDC	-	-	400	V
Power Supply Voltage of Pre-Driver	Vcc	13.5	15.0	16.5	V
Screw Torque (M5)	-	2.5	-	3.0	Nm

9. Weight

Item	Symbol	Min.	Typ.	Max.	Units
Weight	Wt	-	450	-	g

This material and the information herein is the property of Fuji Electric Co., Ltd. They shall be neither reproduced, copied, lent, or disclosed in any way whatsoever for the use of any third party nor used for the manufacturing purposes without the express written consent of Fuji Electric Co., Ltd.

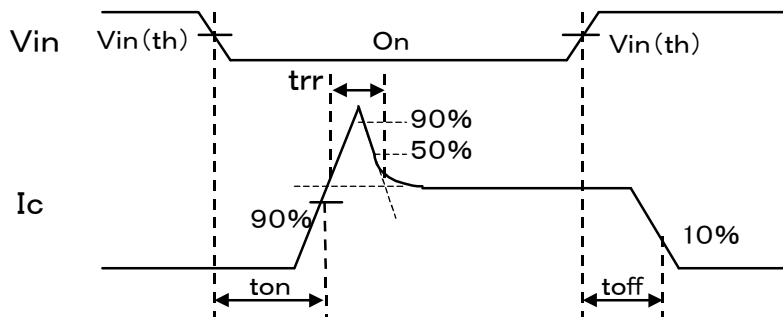
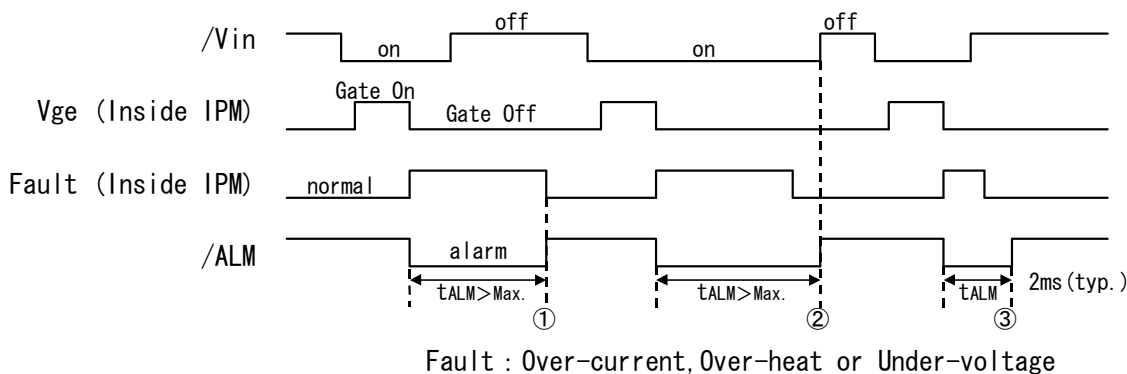

Figure 1. Switching Time Waveform Definitions



Fault : Over-current, Over-heat or Under-voltage

Figure 2. Input/Output Timing Diagram

Necessary conditions for alarm reset (refer to ① to ③ in figure2.)

- ① This represents the case when a failure-causing Fault lasts for a period more than t_{ALM} . The alarm resets when the input V_{in} is OFF and the Fault has disappeared.
- ② This represents the case when the ON condition of the input V_{in} lasts for a period more than t_{ALM} . The alarm resets when the V_{in} turns OFF under no Fault conditions.
- ③ This represents the case when the Fault disappears and the V_{in} turns OFF within t_{ALM} . The alarm resets after lasting for a period of the specified time t_{ALM} .

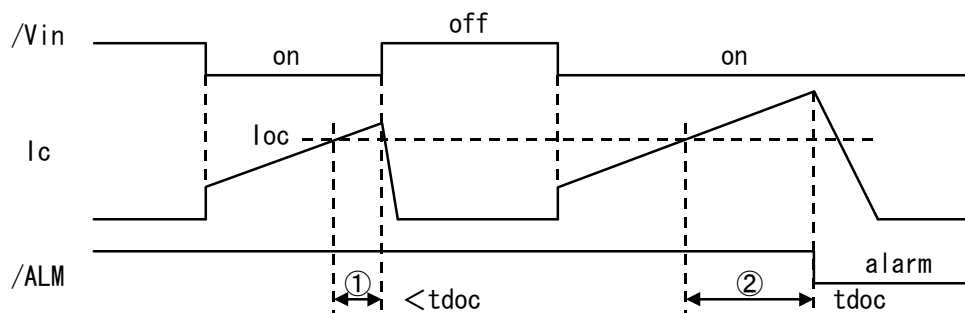

Figure 3. Over-current Protection Timing Diagram

- Period ①: When a collector current over the OC level flows and the OFF command is input within a period less than the trip delay time t_{doc} , the current is hard-interrupted and no alarm is output.
- Period ②: When a collector current over the OC level flows for a period more than the trip delay time t_{doc} , the current is soft-interrupted. If this is detected at the lower arm IGBTs, an alarm is output.

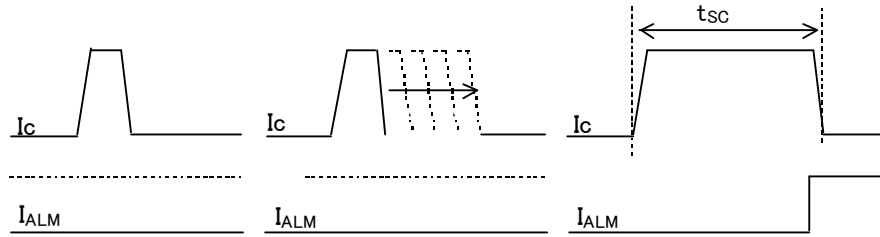

Figure.4 Definition of tsc

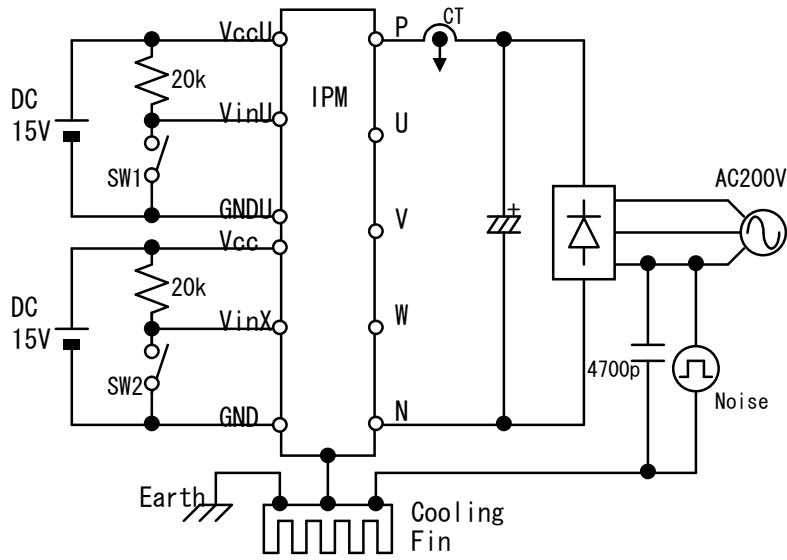

Figure 5. Noise Test Circuit

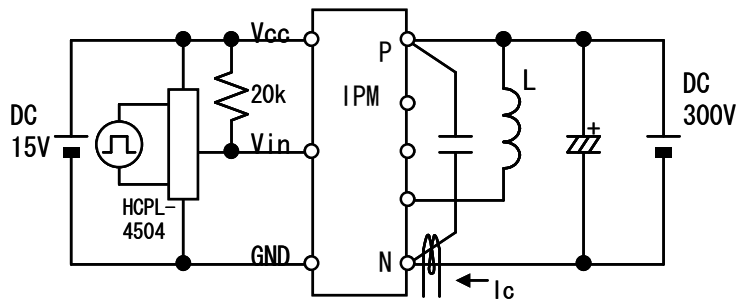

Figure 6. Switching Characteristics Test Circuit

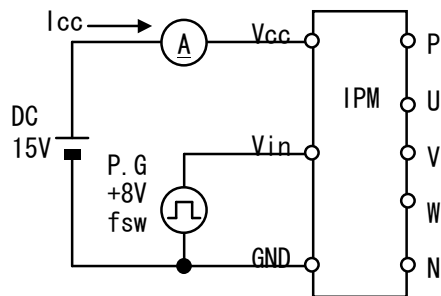

Figure 7. Icc Test Circuit

This material and the information herein is the property of Fuji Electric Co., Ltd. They shall be neither reproduced, copied, lent, or disclosed in any way whatsoever for the use of any third party nor used for the manufacturing purposes without the express written consent of Fuji Electric Co., Ltd.

10. Truth table

10.1 IGBT Control

The following table shows the IGBT ON/OFF status with respect to the input signal Vin.
The IGBT turn-on when Vin is at “Low” level under no alarm condition.

Input (Vin)	Output (IGBT)
Low	ON
High	OFF

10.2 Fault Detection

- (1) When a fault is detected at the high side, only the detected arm stops its output.
At that time the IPM doesn't any alarm.
- (2) When a fault is detected at the low side, all the lower arms stop their outputs and the IPM outputs an alarm of the low side.

	Fault	IGBT				Alarm Output			
		U-phase	V-phase	W-phase	Low side	ALM-U	ALM-V	ALM-W	ALM
High side U-phase	OC	OFF	*	*	*	L	H	H	H
	UV	OFF	*	*	*	L	H	H	H
	TjOH	OFF	*	*	*	L	H	H	H
High side V-phase	OC	*	OFF	*	*	H	L	H	H
	UV	*	OFF	*	*	H	L	H	H
	TjOH	*	OFF	*	*	H	L	H	H
High side W-phase	OC	*	*	OFF	*	H	H	L	H
	UV	*	*	OFF	*	H	H	L	H
	TjOH	*	*	OFF	*	H	H	L	H
Low side	OC	*	*	*	OFF	H	H	H	L
	UV	*	*	*	OFF	H	H	H	L
	TjOH	*	*	*	OFF	H	H	H	L
Case Temperature	TcOH	*	*	*	OFF	H	H	H	L

*: Depend on input logic.

11. Cautions for design and application

1. Trace routing layout should be designed with particular attention to least stray capacity between the primary and secondary sides of optical isolators by minimizing the wiring length between the optical isolators and the IPM input terminals as possible.
 フォトカプラとIPMの入力端子間の配線は極力短くし、フォトカプラの一次側と二次側の浮遊容量を小さくしたパターンレイアウトにしてください。
2. Mount a capacitor between Vcc and GND of each high-speed optical isolator as close to as possible.
 高速フォトカプラのVcc-GND間に、コンデンサを出来るだけ近接して取り付けて下さい。
3. For the high-speed optical isolator, use high-CMR type one with tpHL, tpLH \leq 0.8 μ s.
 高速フォトカプラは、tpHL, tpLH \leq 0.8 μ s、高CMRタイプをご使用ください。
4. For the alarm output circuit, use low-speed type optical isolators with CTR \geq 100%.
 アラーム出力回路は、低速フォトカプラCTR \geq 100%のタイプをご使用ください。
5. For the control power Vcc, use four power supplies isolated each. And they should be designed to reduce the voltage variations.
 制御電源Vccは、絶縁された4電源を使用してください。また、電圧変動を抑えた設計として下さい。
6. Suppress surge voltages as possible by reducing the inductance between the DC bus P and N, and connecting some capacitors between the P and N terminals.
 P-N間の直流母線は出来るだけ低インダクタンス化し、P-N端子間にコンデンサを接続するなどしてサージ電圧を低減して下さい。
7. To prevent noise intrusion from the AC lines, connect a capacitor of some 4700pF between the three-phase lines each and the ground.
 ACラインからのノイズ侵入を防ぐために、3相各線-アース間に4700pF程のコンデンサを接続して下さい。
8. At the external circuit, never connect the control terminal ①GNDU to the main terminal U-phase, ⑤GNDV to V-phase, ⑨GNDW to W-phase, and ⑬GND to N-phase. Otherwise, malfunctions may be caused.
 制御端子①GNDUと主端子U相、制御端子⑤GNDVと主端子V相、制御端子⑨GNDWと主端子W相、制御端子⑬GNDと主端子Nを外部回路で接続しないで下さい。誤動作の原因になります。
9. Take note that an optical isolator's response to the primary input signal becomes slow if a capacitor is connected between the input terminal and GND.
 入力端子-GND間にコンデンサを接続すると、フォトカプラ一次側入力信号に対する応答時間が長くなりますのでご注意ください。

This material and the information herein is the property of Fuji Electric Co.,Ltd. They shall be neither reproduced, copied, lent, or disclosed in any way whatsoever for the use of any third party nor used for the manufacturing purposes without the express written consent of Fuji Electric Co., Ltd.

10. Taking the used isolator's CTR into account, design with a sufficient allowance to decide the primary forward current of the optical isolator.

フォトカプラの一次側電流は、お使いのフォトカプラのCTRを考慮し十分に余裕をもった設計にしてください。

11. Apply thermal compound to the surfaces between the IPM and its heat sink to reduce the thermal contact resistance.

接触熱抵抗を小さくするために、IPMとヒートシンクの上にサーマルコンパウンドを塗布して下さい。

12. Finish the heat sink surface within roughness of 10 μ m and flatness (camber) between screw positions of 0 to +100 μ m. If the flatness is minus, the heat radiation becomes worse due to a gap between the heat sink and the IPM. And, if the flatness is over +100 μ m, there is a danger that the IPM copper base may be deformed and this may cause a dielectric breakdown.

ヒートシンク表面の仕上げは、粗さ10 μ m以下、ネジ位置間での平坦度(反り)は、0~100 μ mとして下さい。平坦度がマイナスの場合、ヒートシンクとIPMの間に隙間ができ放熱が悪化します。また、平坦度が+100 μ m以上の場合IPMの銅ベースが変形し絶縁破壊を起こす危険性があります。

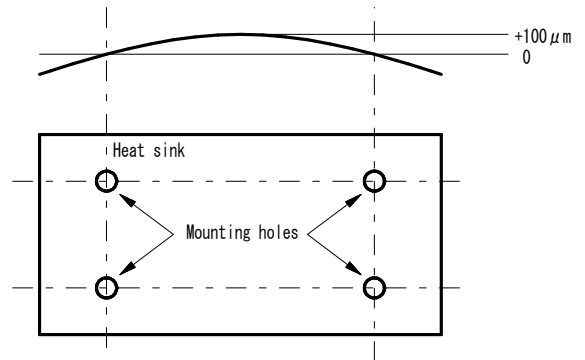

13. This product is designed on the assumption that it applies to an inverter use. Sufficient examination is required when applying to a converter use. Please contact Fuji Electric Co.,Ltd if you would like to applying to converter use.

本製品は、インバータ用途への適用を前提に設計されております。コンバータ用途へ適用される場合は、十分な検討が必要です。もし、コンバータへ適用される場合は御連絡ください。

14. Please see the 『Fuji IGBT-IPM R SERIES APPLICATION MANUAL』 and 『Fuji IGBT MODULES N SERIES APPLICATION MANUAL』.

『富士IGBT-IPM Rシリーズ アプリケーションマニュアル』及び『IGBTモジュール Nシリーズ アプリケーションマニュアル』を御参照ください。

12. Example of applied circuit 応用回路例

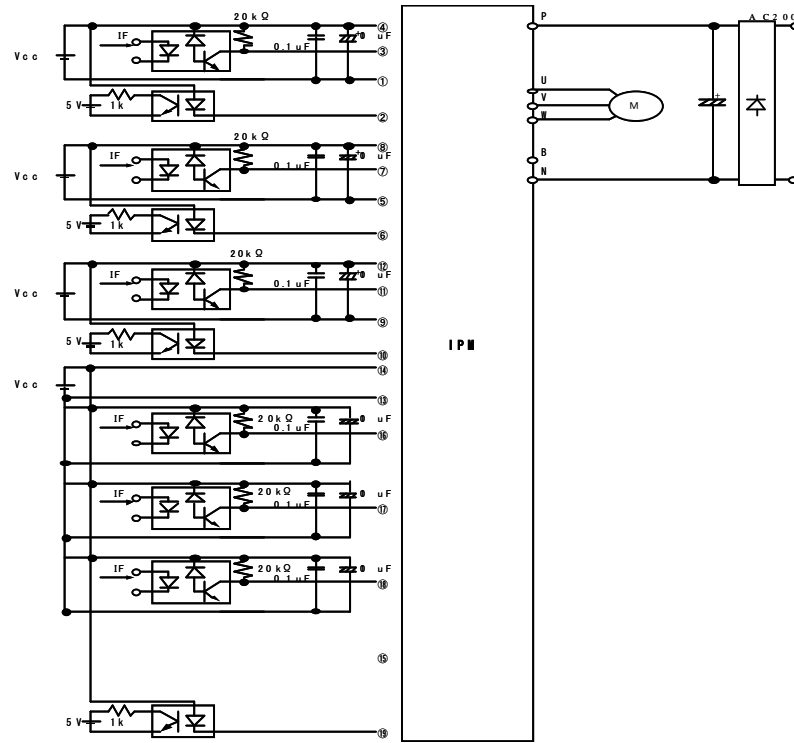

The alarm signal should be connected to Vcc when it is not used.
 不使用のアラーム端子は、制御電源 Vcc に接続して下さい。

13. Package and Marking 梱包仕様

Please see the MT6M4140 which is packing specification of P610 & P611 & P621 package.
 P610, 611, 621 梱包仕様書 MT6M4140を御参照ください。

14. Cautions for storage and transportation 保管、運搬上の注意

- Store the modules at the normal temperature and humidity (5 to 35°C, 45 to 75%).
 常温常湿(5~35°C、45~75%)で保存して下さい。
- Avoid a sudden change in ambient temperature to prevent condensation on the module surfaces.
 モジュールの表面が結露しないよう、急激な温度変化を避けて下さい。
- Avoid places where corrosive gas generates or much dust exists.
 腐食性ガスの発生場所、粉塵の多い場所は避けて下さい。
- Store the module terminals under unprocessed conditions
 モジュールの端子は未加工の状態での保管すること。
- Avoid physical shock or falls during the transportation.
 運搬時に衝撃を与えたり落下させないで下さい。

15. Scope of application 適用範囲

This specification is applied to the IGBT-IPM (type: 6MBP150RTJ060).
 本仕様書は、IGBT-IPM (型式: 6MBP150RTJ060)に適用する。

16. Based safety standards 準拠安全規格

UL1557

17.Characteristics

17-1.Control Circuit Characteristics(Respresentative)

Power supply current vs. Switching frequency
Tc=125°C

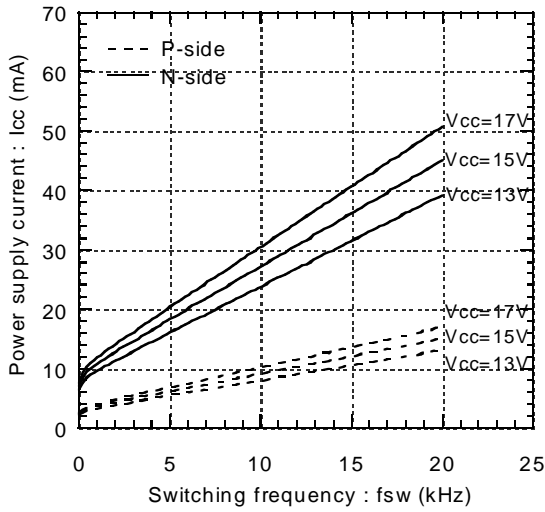

Input signal threshold voltage vs. Power supply voltage
— Tj=25°C
--- Tj=125°C

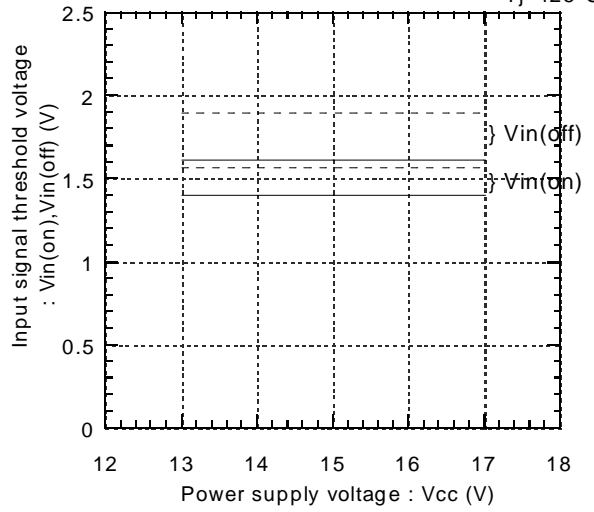

Under voltage vs. Junction temperature

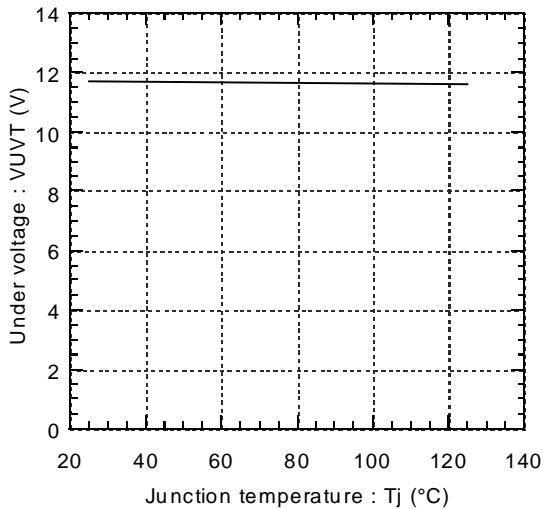

Under voltage hysteresis vs. Jnction temperature

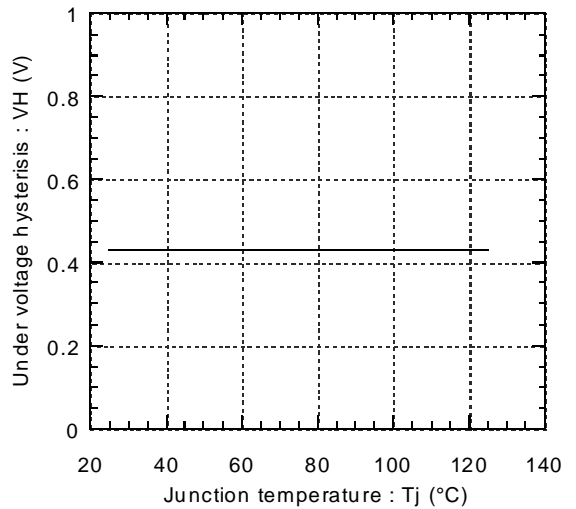

Alarm hold time vs. Power supply voltage

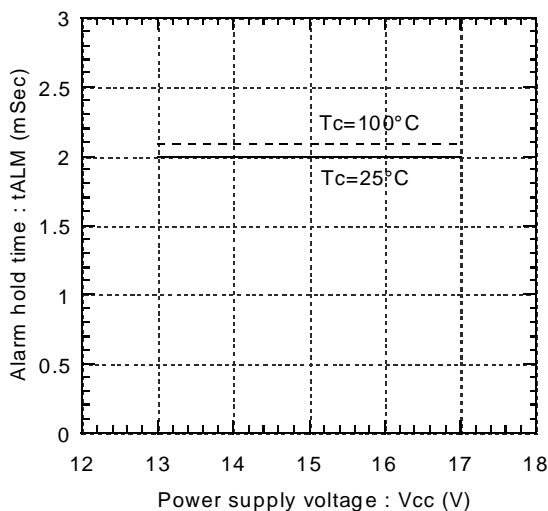

Over heating characteristics
TcOH, TjOH, TcH, TjH vs. Vcc

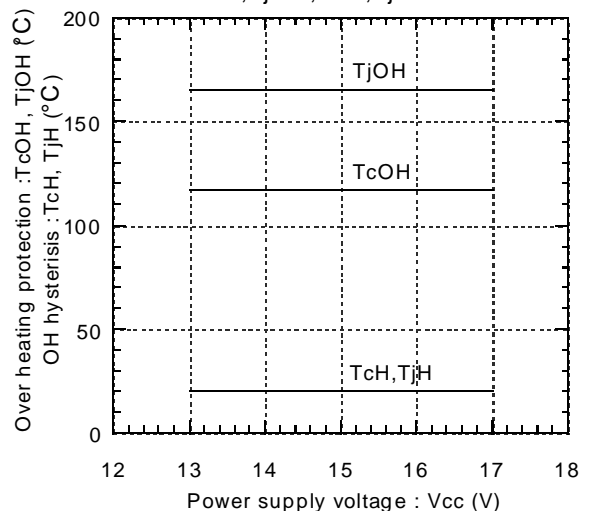

This material and the information herein is the property of Fuji Electric Co.Ltd. They shall be neither reproduced, copied, lent, or disclosed in any way whatsoever for the use of any third party nor used for the manufacturing purposes without the express written consent of Fuji Electric Co., Ltd.

17-2.Main Circuit Characteristics (Representative)

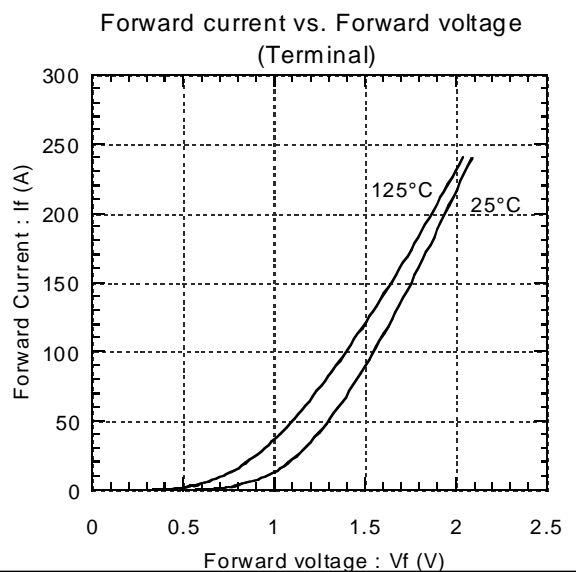
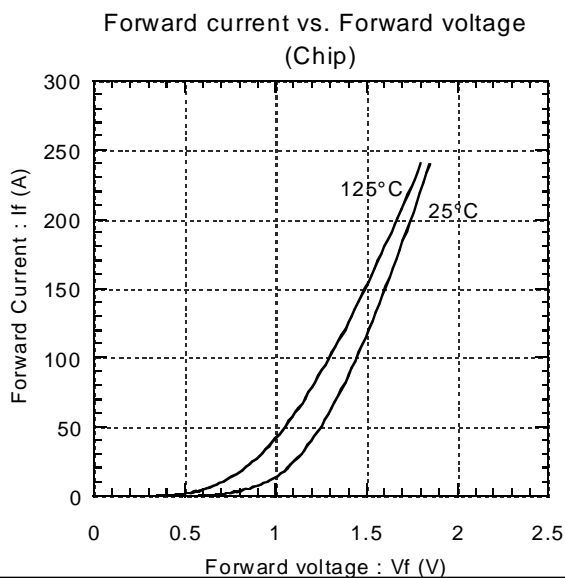
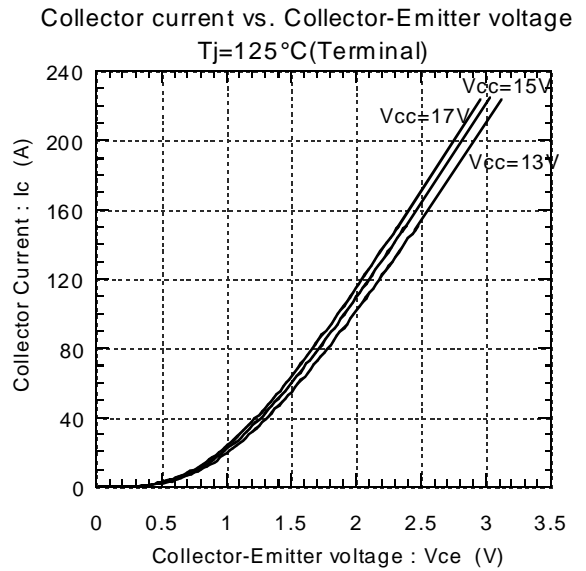
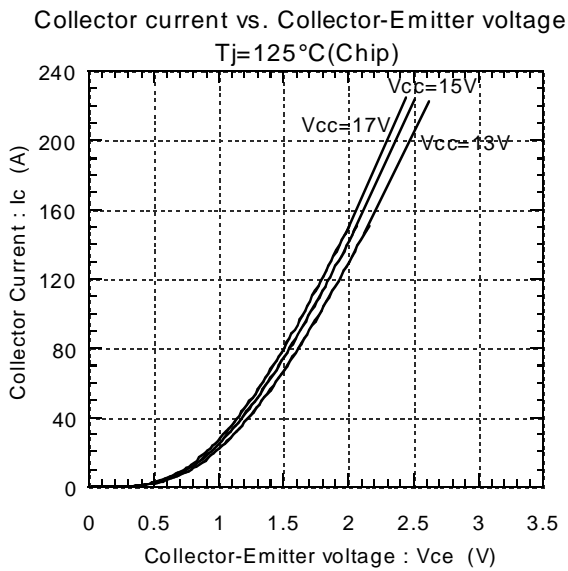
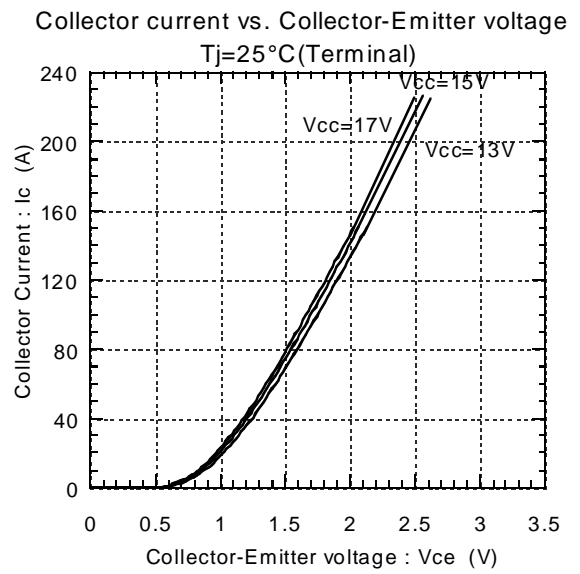
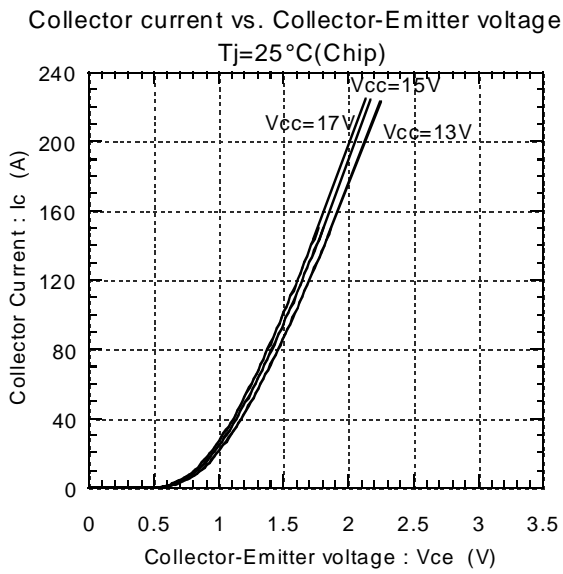

This material and the information herein is the property of Fuji Electric Co., Ltd. They shall be neither reproduced, copied, lent, or disclosed in any way whatsoever for the use of any third party nor used for the manufacturing purposes without the express written consent of Fuji Electric Co., Ltd.

This material and the information herein is the property of Fuji Electric Co., Ltd. They shall be neither reproduced, copied, lent, or disclosed in any way whatsoever for the use of any third party nor used for the manufacturing purposes without the express written consent of Fuji Electric Co., Ltd.

Switching Loss vs. Collector Current
 $E_{dc}=300V, V_{cc}=15V, T_j=25^\circ C$

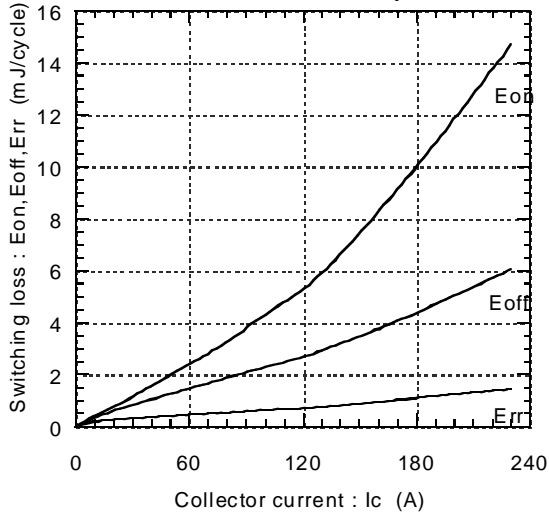

Switching Loss vs. Collector Current
 $E_{dc}=300V, V_{cc}=15V, T_j=125^\circ C$

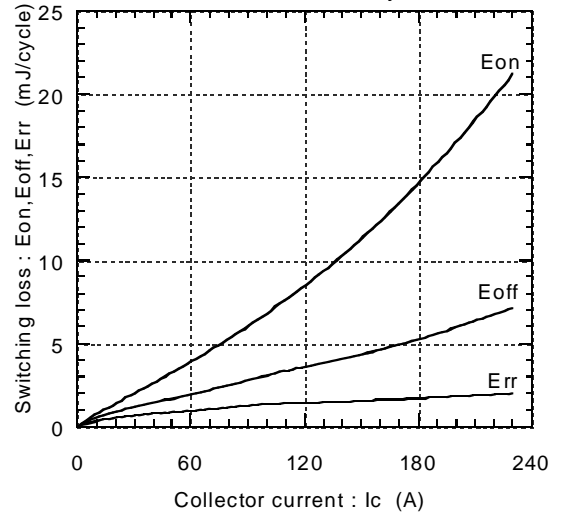

Reversed biased safe operating area
 $V_{cc}=15V, T_j \le 125^\circ C$

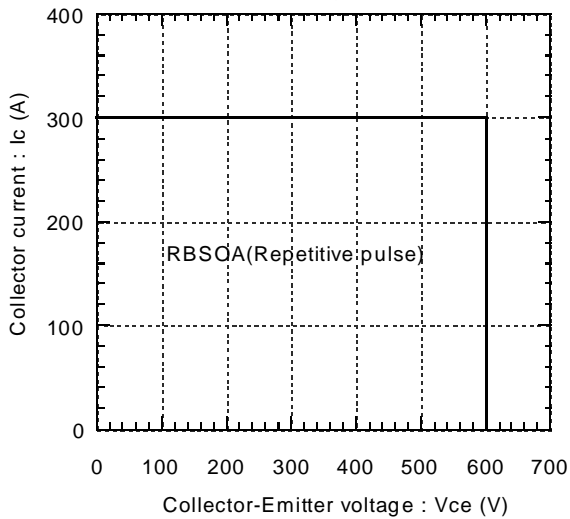

Transient thermal resistance

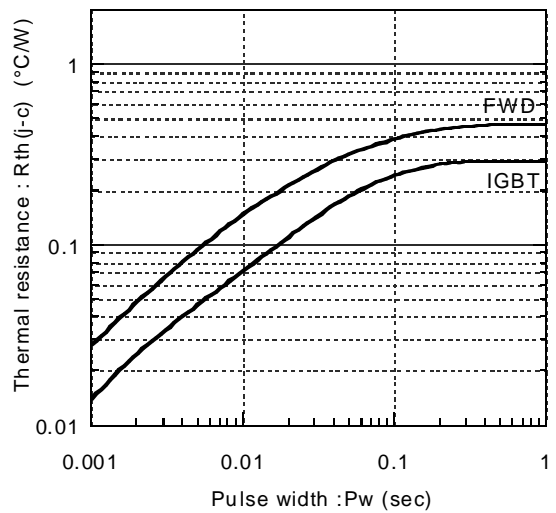

Power derating for IGBT
 (per device)

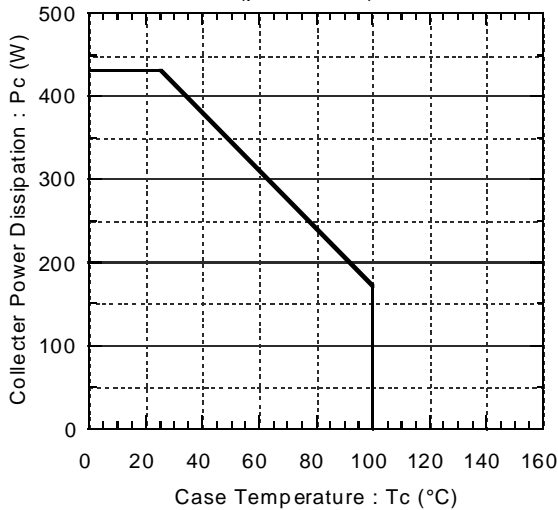

Power derating for FWD
 (per device)

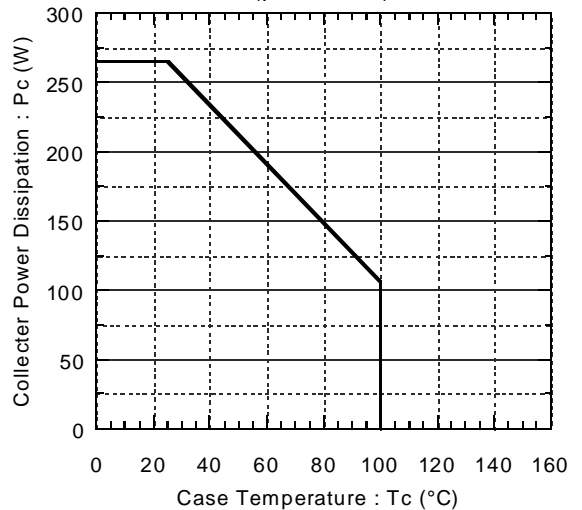

This material and the information herein is the property of Fuji Electric Co., Ltd. They shall be neither reproduced, copied, lent, or disclosed in any way whatsoever for the use of any third party nor used for the manufacturing purposes without the express written consent of Fuji Electric Co., Ltd.

Switching time vs. Collector current
 $E_{dc}=300V, V_{cc}=15V, T_j=25^\circ C$

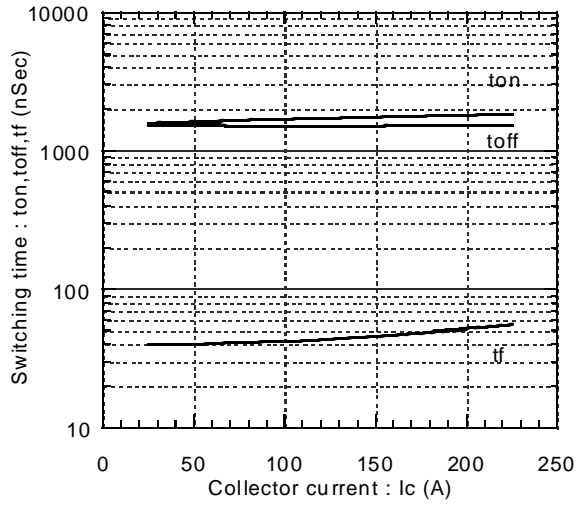

Switching time vs. Collector current
 $E_{dc}=300V, V_{cc}=15V, T_j=125^\circ C$

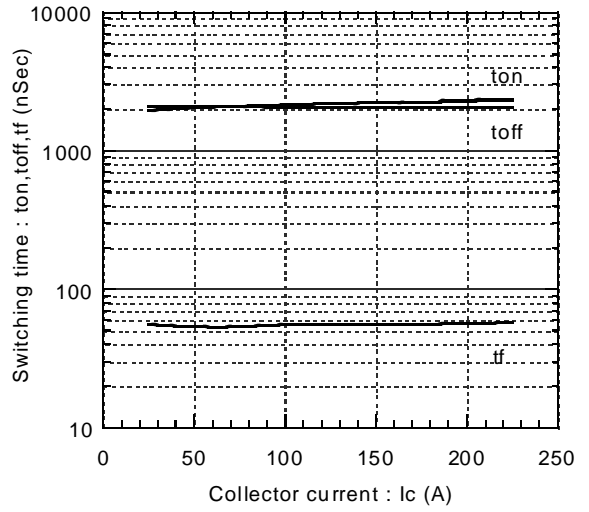

Reverse recovery characteristics
 t_{rr}, I_{rr} vs. I_F

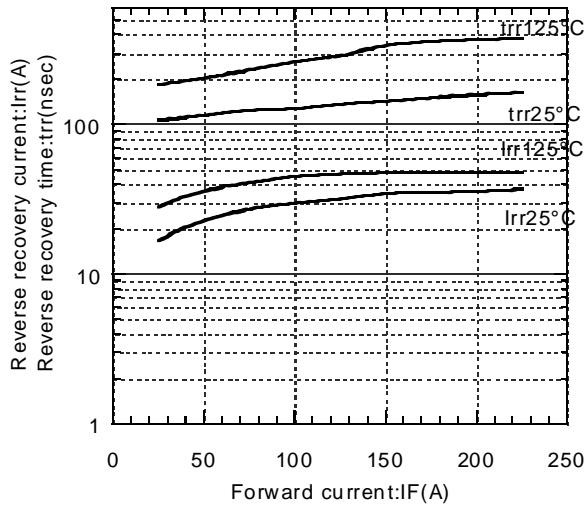

(a)

18. Reliability Test Items

Test categories	Test items	Test methods and conditions	Reference norms EIAJ ED-4701	Number of sample	Acceptance number
Mechanical Tests	1 Terminal strength 端子強度 (Pull test)	Pull force : 40 N (main terminal) 10 N (control terminal) Test time : 10 ±1 sec.	Test Method 401 Method I	5	(1 : 0)
	2 Mounting Strength 締付け強度	Screw torque : 2.5 ~ 3.5 N·m (M5) Test time : 10 ±1 sec.	Test Method 402 method II	5	(1 : 0)
	3 Vibration 振動	Range of frequency : 10~500 Hz Sweeping time : 15 min. Acceleration : 100 m/s ² Sweeping direction : Each X,Y,Z axis Test time : 6 hr. (2hr./direction)	Test Method 403 Condition code B	5	(1 : 0)
	4 Shock 衝撃	Maximum acceleration : 5000 m/s ² Pulse width : 1.0 ms Direction : Each X,Y,Z axis Test time : 3 times/direction	Test Method 404 Condition code B	5	(1 : 0)
	5 Solderability はんだ付け性	Solder temp. : 235 ±5 °C Immersion duration : 5.0 ±0.5 sec. Test time : 1 time Each terminal should be immersed in solder within 1~1.5mm from the body.	Test Method 303 Condition code A	5	(1 : 0)
	6 Resistance to soldering heat はんだ耐熱性	Solder temp. : 260 ±5 °C Immersion time : 10 ±1sec. Test time : 1 time Each terminal should be immersed in solder within 1~1.5mm from the body.	Test Method 302 Condition code A	5	(1 : 0)
Environment Tests	1 High temperature storage 高温保存	Storage temp. : 125 ±5 °C Test duration : 1000 hr.	Test Method 201	5	(1 : 0)
	2 Low temperature storage 低温保存	Storage temp. : -40 ±5 °C Test duration : 1000 hr.	Test Method 202	5	(1 : 0)
	3 Temperature humidity storage 高温高湿保存	Storage temp. : 85 ±2 °C Relative humidity : 85 ±5% Test duration : 1000hr.	Test Method 103 Test code C	5	(1 : 0)
	4 Unsaturated pressure cooker プレッシャークッカー	Test temp. : 120 ±2 °C Atmospheric pressure : 1.7x10 ⁵ Pa Test humidity : 85 ±5% Test duration : 96 hr.	Test Method 103 Test code E	5	(1 : 0)
	5 Temperature cycle 温度サイクル	Test temp. : Minimum storage temp. -40 ±5°C Maximum storage temp. 125 ±5°C Normal temp. 5 ~ 35°C Dwell time : Tmin ~ TN ~ Tmax ~ TN 1hr. 0.5hr. 1hr. 0.5hr. Number of cycles : 100 cycles	Test Method 105	5	(1 : 0)
	6 Thermal shock 熱衝撃	Test temp. : High temp. side 100 ⁺⁰ °C Low temp. side 0 ⁺⁵ °C Fluid used : Pure water (running water) Dipping time : 5 min. par each temp. Transfer time : 10 sec. Number of cycles : 10 cycles	Test Method 307 method I Condition code A	5	(1 : 0)

This material and the information herein is the property of Fuji Electric Co., Ltd. They shall be neither reproduced, copied, lent, or disclosed in any way whatsoever for the use of any third party nor used for the manufacturing purposes without the express written consent of Fuji Electric Co., Ltd.

Fuji Electric Co., Ltd.

DWG.NO.

MS6M 0677

19 / 22

a

H04-004-03

(a)

Test categories	Test items	Test methods and conditions	Reference norms EIAJ ED-4701	Number of sample	Acceptance number
Endurance Tests	1 High temperature reverse bias 高温逆バイアス	Test temp. : $T_a = 125 \pm 5^\circ\text{C}$ ($T_j \leq 150^\circ\text{C}$) Bias Voltage : $V_C = 0.8 \times V_{CES}$ Bias Method : Applied DC voltage to C-E $V_{cc} = 15\text{V}$ Test duration : 1000 hr.	Test Method 101	5	(1:0)
	2 Temperature humidity bias 高温高湿バイアス	Test temp. : $85 \pm 2^\circ\text{C}$ Relative humidity : $85 \pm 5\%$ Bias Voltage : $V_C = 0.8 \times V_{CES}$ $V_{cc} = 15\text{V}$ Bias Method : Applied DC voltage to C-E Test duration : 1000 hr.	Test Method 102 Condition code C	5	(1:0)
	3 Intermitted operating life (Power cycle) 断続動作	ON time : 2 sec. OFF time : 18 sec. Test temp. : $\Delta T_j = 100 \pm 5\text{deg}$ $T_j \leq 150^\circ\text{C}$, $T_a = 25 \pm 5^\circ\text{C}$ Number of cycles : 15000 cycles	Test Method 106	5	(1:0)

19. Failure Criteria

Item	Characteristic	Symbol	Failure criteria		Unit	Note	
			Lower limit	Upper limit			
Electrical characteristic	Leakage current	ICES	-	USLx2	mA		
	Saturation voltage	VCE(sat)	-	USLx1.2	V		
	Forward voltage	VF	-	USLx1.2	V		
	Thermal resistance	IGBT	Rth(j-c)	-	USLx1.2	$^\circ\text{C}/\text{W}$	
		FWD	Rth(j-c)	-	USLx1.2	$^\circ\text{C}/\text{W}$	
	Over Current Protection	Ioc	LSLx0.8	USLx1.2	A		
	Alarm signal hold time	tALM	LSLx0.8	USLx1.2	ms		
	Over heating Protection	TcOH	LSLx0.8	USLx1.2	$^\circ\text{C}$		
Isolation voltage	Viso	Broken insulation		-			
Visual inspection	Visual inspection	-	The visual sample		-		
	Peeling Plating and the others						

LSL : Lower specified limit.

USL : Upper specified limit.

Note : Each parameter measurement read-outs shall be made after stabilizing the components at room ambient for 2 hours minimum, 24 hours maximum after removal from the tests. And in case of the wetting tests, for example, moisture resistance tests, each component shall be made wipe or dry completely before the measurement.

Warnings

1. This product shall be used within its absolute maximum rating (voltage, current, and temperature).
This product may be broken in case of using beyond the ratings.
製品の絶対最大定格(電圧, 電流, 温度等)の範囲内で御使用下さい。絶対最大定格を超えて使用すると、素子が破壊する場合があります。

2. Connect adequate fuse or protector of circuit between three-phase line and this product to prevent the equipment from causing secondary destruction.
万一の不慮の事故で素子が破壊した場合を考慮し、商用電源と本製品の間に適切な容量のヒューズ又はブレーカーを必ず付けて2次破壊を防いでください。

3. When studying the device at a normal turn-off action, make sure that working paths of the turn-off voltage and current are within the RBSOA specification. And ,when studying the device duty at a short-circuit current non-repetitive interruption, make sure that the paths are also within the avalanche proof(PAV) specification which is calculated from the snubber inductance, the IPM inner inductance and the turn-off current. In case of use of IGBT-IPM over these specifications, it might be possible to be broken.
通常のターンオフ動作における素子責務の検討の際には、ターンオフ電圧・電流の動作軌跡がRBSOA仕様内にあることを確認して下さい。また、非繰返しの短絡電流遮断における素子責務の検討に際しては、スナバーインダクタンスとIPM内部インダクタンス及びターンオフ電流から算出されるアバランシェ耐量(PAV)仕様内である事を確認して下さい。これらの仕様を越えて使用すると、素子が破壊する場合があります。

4. Use this product after realizing enough working on environment and considering of product's reliability life. This product may be broken before target life of the system in case of using beyond the product's reliability life.
製品の使用環境を十分に把握し、製品の信頼性寿命が満足できるか検討の上、本製品を適用して下さい。製品の信頼性寿命を超えて使用した場合、装置の目標寿命より前に素子が破壊する場合があります。

5. If the product had been used in the environment with acid, organic matter, and corrosive gas (For example : hydrogen sulfide, sulfurous acid gas), the product's performance and appearance can not be ensured easily.
酸・有機物・腐食性ガス(硫化水素, 亜硫酸ガス等)を含む環境下で使用された場合、製品機能・外観などの保証は致しかねます。

6. The thermal stress generated from rise and fall of Tj restricts the product lifetime.
You should estimate the ΔT_j from power losses and thermal resistance, and design the inverter lifetime within the number of cycles provided from the power cycle curve. (Technical Rep. No.: MT6M4057)
製品の寿命は、接合温度の上昇と下降によって起こる熱ストレスで決まります。損失と熱抵抗から ΔT_j を推定し、パワーサイクル寿命カーブで決まるサイクル数以下で、インバータの寿命を設計して下さい(技術資料No.: MT6M4057)。

7. Never add mechanical stress to deform the main or control terminal.
The deformed terminal may cause poor contact problem.
主端子及び制御端子に応力を与えて変形させないで下さい。 端子の変形により、接触不良などを引き起こす場合があります。

This material and the information herein is the property of Fuji Electric Co., Ltd. They shall be neither reproduced, copied, lent, or disclosed in any way whatsoever for the use of any third party nor used for the manufacturing purposes without the express written consent of Fuji Electric Co., Ltd.

Fuji Electric Co.,Ltd.	DWG.NO.	MS6M 0677	21 — 22	a
-------------------------------	---------	-----------	---------------	---

This material and the information herein is the property of Fuji Electric Co., Ltd. They shall be neither reproduced, copied, lent, or disclosed in any way whatsoever for the use of any third party nor used for the manufacturing purposes without the express written consent of Fuji Electric Co., Ltd.

8. Never add mechanical stress to deform the main or control terminal.
 The deformed terminal may cause poor contact problem.
 主端子及び制御端子に応力を与えて変形させないで下さい。端子の変形により、接触不良などを引き起こす場合があります。
9. If excessive static electricity is applied to the control terminals, the devices can be broken.
 Implement some countermeasures against static electricity.
 制御端子に過大な静電気が印加された場合、素子が破壊する場合があります。取り扱い時は静電気対策を実施して下さい。

Caution

1. Fuji Electric is constantly making every endeavor to improve the product quality and reliability. However, semiconductor products may rarely happen to fail or malfunction. To prevent accidents causing injury or death, damage to property like by fire, and other social damage resulted from a failure or malfunction of the Fuji Electric semiconductor products, take some measures to keep safety such as redundant design, spread-fire-preventive design, and malfunction-protective design.
 富士電機は絶えず製品の品質と信頼性の向上に努めています。しかし、半導体製品は故障が発生したり、誤動作する場合があります。富士電機製半導体製品の故障または誤動作が、結果として人身事故・火災等による財産に対する損害や社会的な損害を起こさないように冗長設計・延焼防止設計・誤動作防止設計など安全確保のための手段を講じて下さい。
2. The application examples described in this specification only explain typical ones that used the Fuji Electric products. This specification never ensure to enforce the industrial property and other rights, nor license the enforcement rights.
 本仕様書に記載してある応用例は、富士電機製品を使用した代表的な応用例を説明するものであり、本仕様書によって工業所有権、その他権利の実施に対する保障または実施権の許諾を行うものではありません。
3. The product described in this specification is not designed nor made for being applied to the equipment or systems used under life-threatening situations. When you consider applying the product of this specification to particular used, such as vehicle-mounted units, shipboard equipment, aerospace equipment, medical devices, atomic control systems and submarine relaying equipment or systems, please apply after confirmation of this product to be satisfied about system construction and required reliability.
 本仕様書に記載された製品は、人命にかかわるような状況下で使用される機器あるいはシステムに用いられることを目的として設計・製造されたものではありません。本仕様書の製品を車両機器、船舶、航空宇宙、医療機器、原子力制御、海底中継機器あるいはシステムなど、特殊用途へのご利用をご検討の際は、システム構成及び要求品質に満足することをご確認の上、ご利用下さい。

If there is any unclear matter in this specification, please contact Fuji Electric Co., Ltd.

Fuji Electric Co.,Ltd.	DWG.NO.	MS6M 0677	22 / 22	a
-------------------------------	---------	-----------	------------	---