

# 6MBP300RA060

## IGBT-IPM R series

600V / 300A 6 in one-package

### Features

- Temperature protection provided by directly detecting the junction temperature of the IGBTs
- Low power loss and soft switching
- High performance and high reliability IGBT with overheating protection
- Higher reliability because of a big decrease in number of parts in built-in control circuit

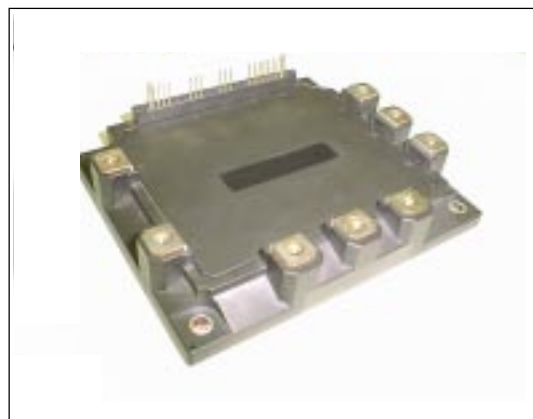

### Maximum ratings and characteristics

- Absolute maximum ratings(at  $T_c=25^\circ\text{C}$  unless otherwise specified)

Item	Symbol	Rating		Unit	
		Min.	Max.		
DC bus voltage	V <sub>DC</sub>	0	450	V	
DC bus voltage (surge)	V <sub>DC(surge)</sub>	0	500	V	
DC bus voltage (short operating)	V <sub>SC</sub>	200	400	V	
Collector-Emitter voltage	V <sub>CES</sub>	0	600	V	
INV Collector current	DC	I <sub>C</sub>	-	300	A
		I <sub>CP</sub>	-	600	A
		-I <sub>C</sub>	-	300	A
	Duty=55.5%	-I <sub>C</sub>	-	300	A
Collector power dissipation	One transistor	P <sub>C</sub>	-	1040	W
Junction temperature	T <sub>j</sub>	-	150	°C	
Input voltage of power supply for Pre-Driver	V <sub>CC</sub> *1	0	20	V	
Input signal voltage	V <sub>in</sub> *2	0	V <sub>Z</sub>	V	
Input signal current	I <sub>in</sub>	-	1	mA	
Alarm signal voltage	V <sub>ALM</sub> *3	0	V <sub>CC</sub>	V	
Alarm signal current	I <sub>ALM</sub> *4	-	15	mA	
Storage temperature	T <sub>stg</sub>	-40	125	°C	
Operating case temperature	T <sub>op</sub>	-20	100	°C	
Isolating voltage (Case-Terminal)	V <sub>iso</sub> *5	-	AC2.5	kV	
Screw torque	Mounting (M5)	-	3.5 *6	N·m	
	Terminal (M5)	-	3.5 *6	N·m	

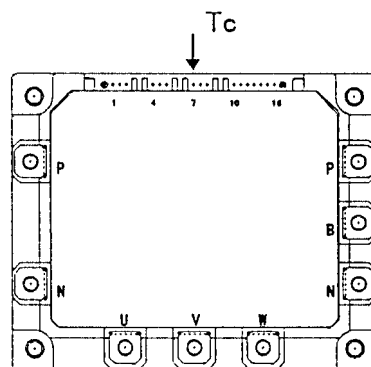

Fig.1 Measurement of case temperature

\*1 Apply V<sub>CC</sub> between terminal No. 3 and 1, 6 and 4, 9 and 7, 11 and 10.

\*2 Apply V<sub>in</sub> between terminal No. 2 and 1, 5 and 4, 8 and 7, 13,14,15 and 10.

\*3 Apply V<sub>ALM</sub> between terminal No. 16 and 10.

\*4 Apply I<sub>ALM</sub> to terminal No. 16.

\*5 50Hz/60Hz sine wave 1 minute.

\*6 Recommendable Value : 2.5 to 3.0 N·m

- Electrical characteristics of power circuit (at  $T_c=T_j=25^\circ\text{C}$ , V<sub>CC</sub>=15V)

Item	Symbol	Condition	Min.	Typ.	Max.	Unit	
INV	Collector current at off signal input	I <sub>CES</sub>	V <sub>CE</sub> =600V input terminal open	-	-	1.0	mA
	Collector-Emitter saturation voltage	V <sub>CE(sat)</sub>	I <sub>C</sub> =300A	-	-	2.8	V
	Forward voltage of FWD	V <sub>F</sub>	-I <sub>C</sub> =300A	-	-	3.0	V

● Electrical characteristics of control circuit(at Tc=Tj=25°C, Vcc=15V)

Item	Symbol	Condition	Min.	Typ.	Max.	Unit
Power supply current of P-line side Pre-driver(one unit)	I <sub>ccp</sub>	fsw=0 to 15kHz Tc=-20 to 100°C *7	6	-	32	mA
Power supply current of N-line side three Pre-driver	I <sub>ccn</sub>	fsw=0 to 15kHz Tc=-20 to 100°C *7	18	-	96	mA
Input signal threshold voltage (on/off)	V <sub>in(th)</sub>	ON	1.00	1.35	1.70	V
		OFF	1.70	2.05	2.40	V
Input zener voltage	V <sub>z</sub>	R <sub>in</sub> =20k ohm	-	8.0	-	V
Over heating protection temperature level	T <sub>COH</sub>	VDC=0V, I <sub>c</sub> =0A, Case temperature, Fig.1	110	-	125	°C
Hysteresis	T <sub>CH</sub>		-	20	-	°C
IGBT chips over heating protection temperature level	T <sub>JOH</sub>	surface of IGBT chips	150	-	-	°C
Hysteresis	T <sub>JH</sub>		-	20	-	°C
Collector current protection level	INV	I <sub>oc</sub>	T <sub>j</sub> =125°C	450	-	A
Over current protection delay time	t <sub>DOC</sub>	T <sub>j</sub> =25°C Fig.2	-	10	-	μs
Under voltage protection level	V <sub>UV</sub>		11.0	-	12.5	V
Hysteresis	V <sub>H</sub>		0.2	-	-	V
Alarm signal hold time	t <sub>ALM</sub>		1.5	2	-	ms
SC protection delay time	t <sub>SC</sub>	T <sub>j</sub> =25°C Fig.3	-	-	12	μs
Limiting resistor for alarm	R <sub>ALM</sub>		1425	1500	1575	ohm

\*7 Switching frequency of IPM

● Dynamic characteristics(at Tc=Tj=125°C, Vcc=15V)

Item	Symbol	Condition	Min.	Typ.	Max.	Unit
Switching time (IGBT)	t <sub>on</sub>	I <sub>C</sub> =300A, VDC=300V	0.3	-	-	μs
	t <sub>off</sub>					
Switching time (FWD)	t <sub>rr</sub>	I <sub>F</sub> =300A, VDC=300V	-	-	0.4	μs

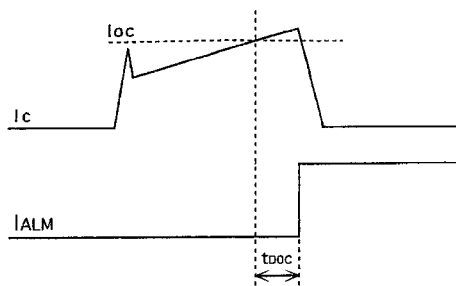

Fig.2 Definition of OC delay time

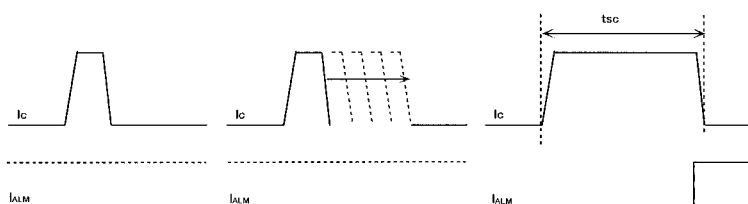

Fig.3 Definition of tsc

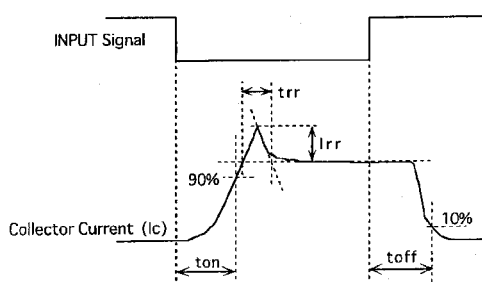

Fig.4 Definition of switching time

● Thermal characteristics( Tc=25°C)

Item	Symbol	Typ.	Max.	Unit
Junction to Case thermal resistance	INV	R <sub>th(j-c)</sub>	0.12	°C/W
	IGBT			
Case to fin thermal resistance with compound	INV	R <sub>th(j-c)</sub>	0.25	°C/W
	FWD			
	R <sub>th(c-f)</sub>	0.05	-	°C/W

● Recommendable value

Item	Symbol	Min.	Typ.	Max.	Unit	
DC bus voltage	VDC	200	-	400	V	
Operating power supply voltage range of Pre-driver	VCC	13.5	15	16.5	V	
Switching frequency of IPM	fsw	1	-	20	kHz	
Screw torque	Mounting (M5)	-	2.5	-	3.0	N·m
	Terminal (M5)	-	2.5	-	3.0	N·m

Block diagram

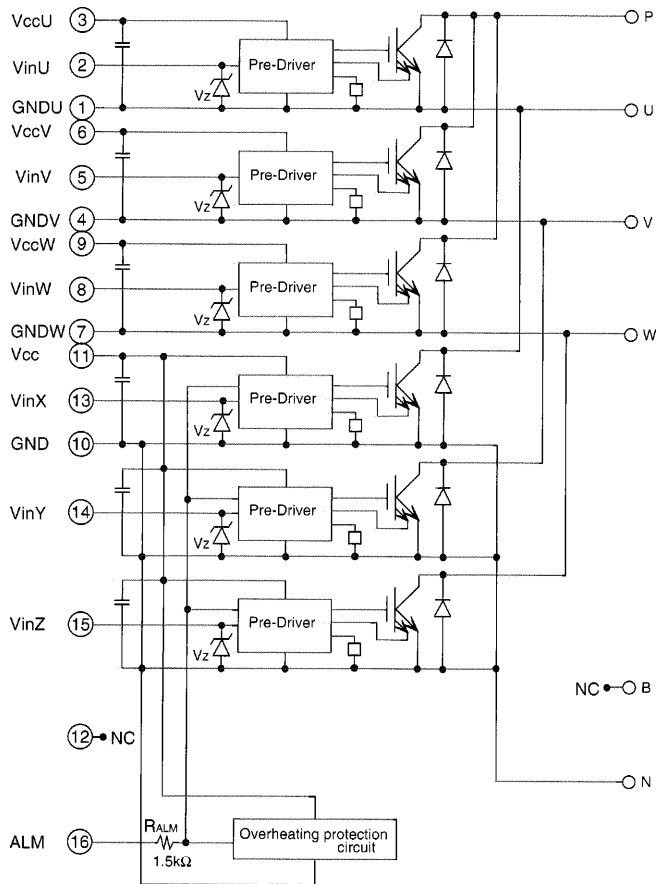

- Pre-drivers include following functions
- a) Amplifier for driver
  - b) Short circuit protection
  - c) Undervoltage lockout circuit
  - d) Over current protection
  - e) IGBT chip over heating protection

Outline drawings, mm

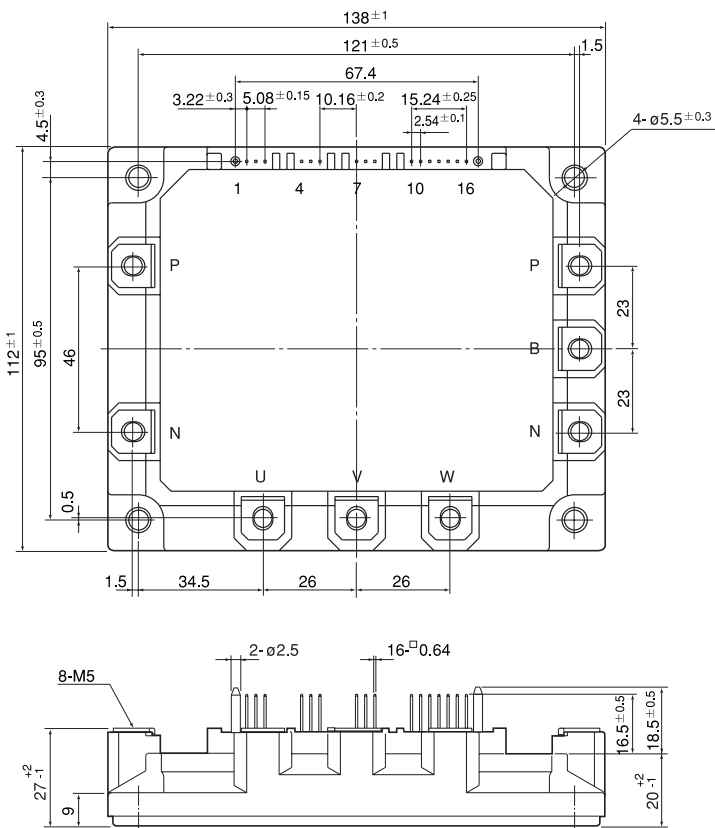

Mass : 920g

■ Characteristics (Representative)

● Control circuit

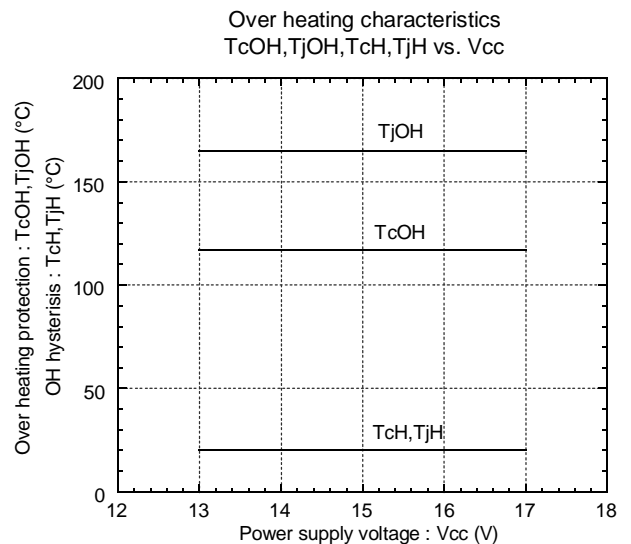
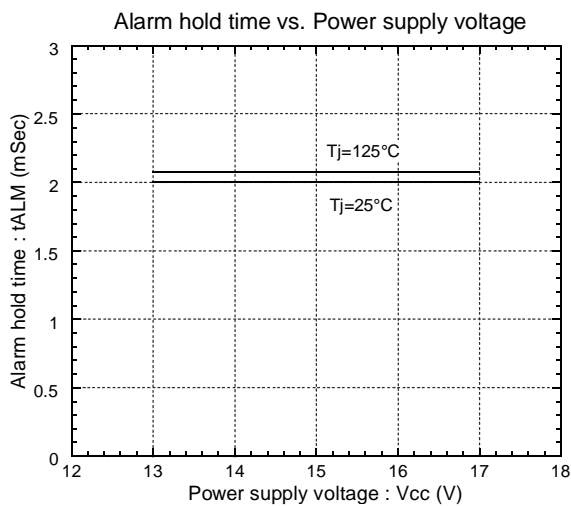
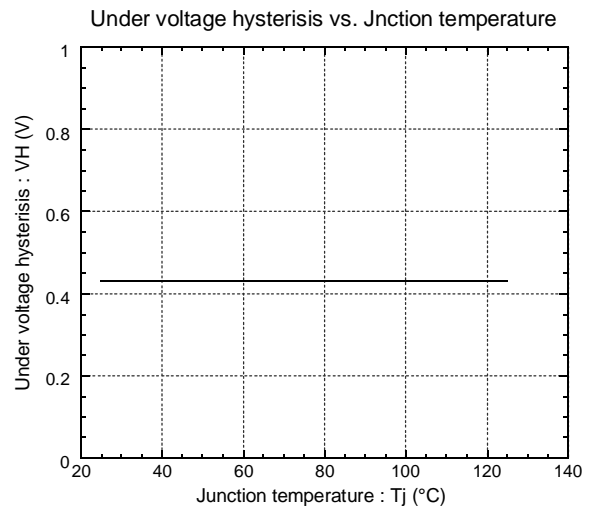
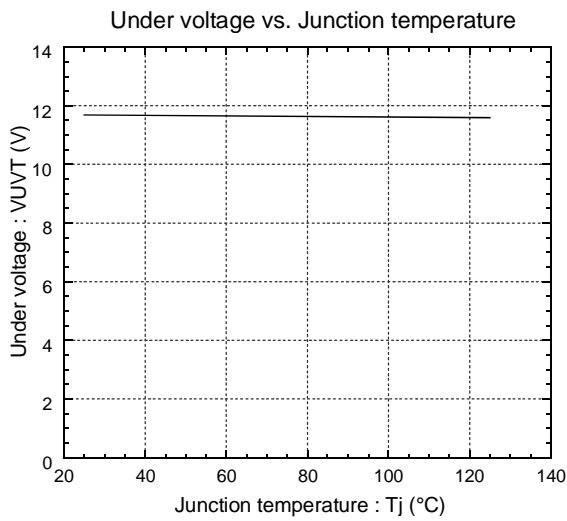
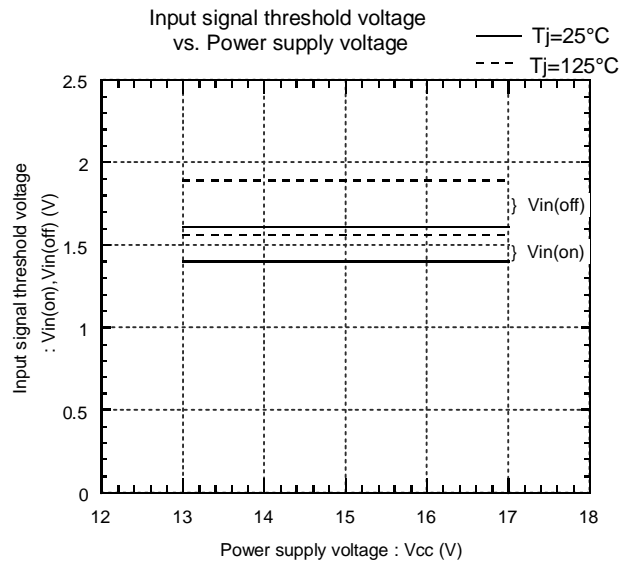
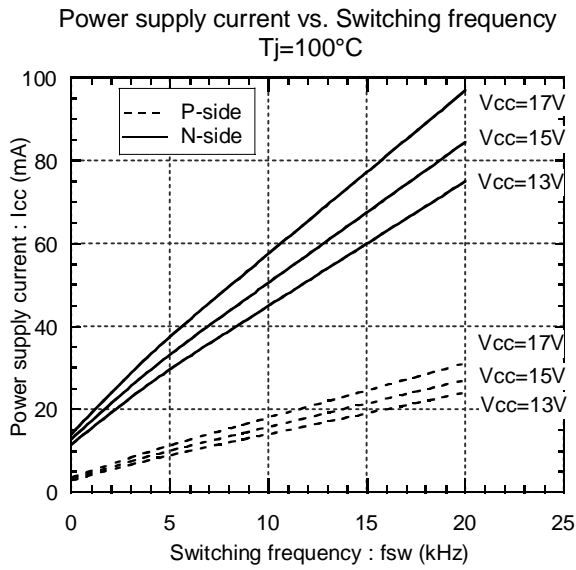

● Inverter

Collector current vs. Collector-Emmitter voltage  
T<sub>j</sub>=25°C

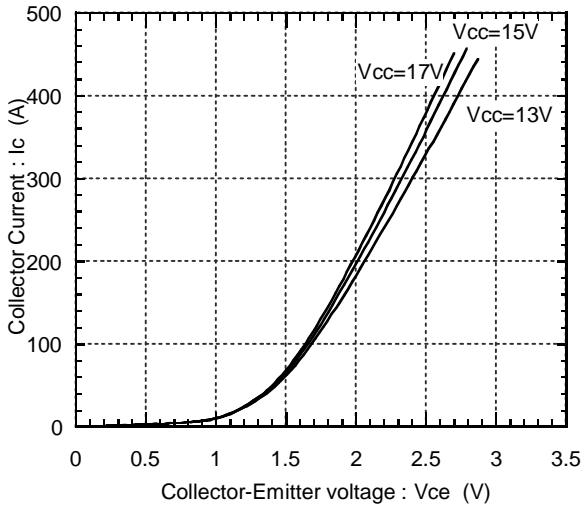

Collector current vs. Collector-Emmitter voltage  
T<sub>j</sub>=125°C

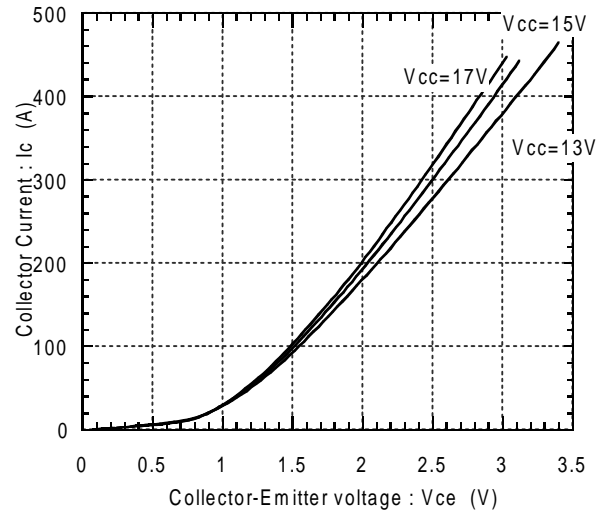

Switching time vs. Collector current  
E<sub>dc</sub>=300V, V<sub>cc</sub>=15V, T<sub>j</sub>=25°C

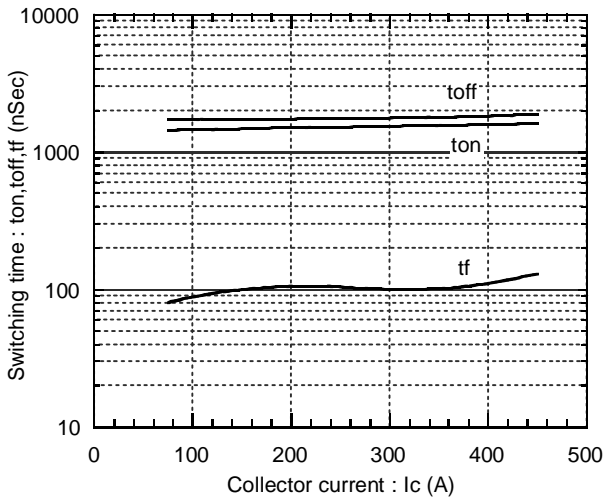

Switching time vs. Collector current  
E<sub>dc</sub>=300V, V<sub>cc</sub>=15V, T<sub>j</sub>=125°C

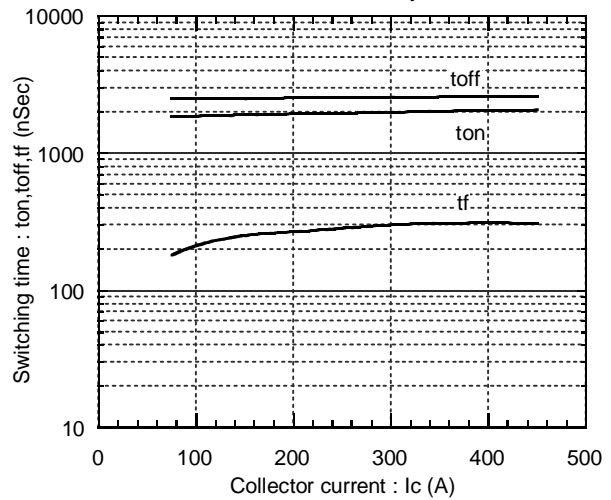

Forward current vs. Forward voltage

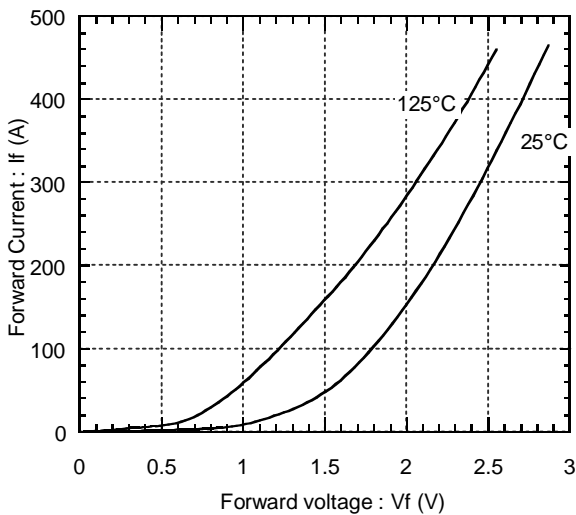

Reverse recovery characteristics  
trr, Irr vs. IF

