

MITSUBISHI IGBT MODULES
CM150DY-24A

HIGH POWER SWITCHING USE

CM150DY-24A



- IC 150A
- VCES 1200V
- Insulated Type
- 2-elements in a pack

APPLICATION

AC drive inverters & Servo controls, etc

OUTLINE DRAWING & CIRCUIT DIAGRAM

Dimensions in mm

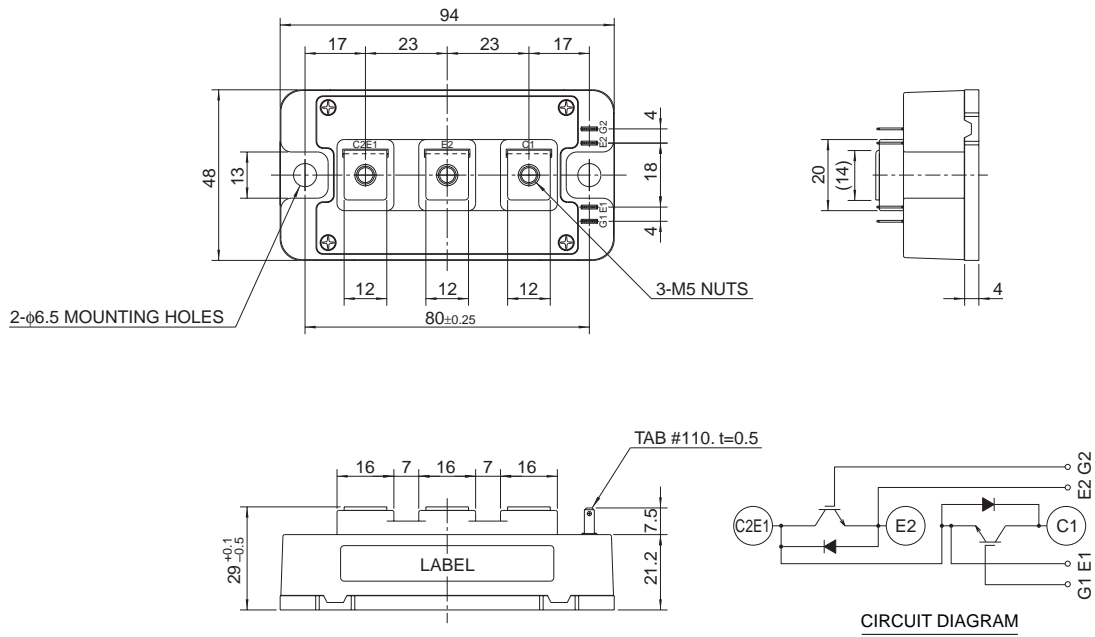

ABSOLUTE MAXIMUM RATINGS (T_j = 25°C)

Symbol	Parameter	Conditions	Ratings	Unit
V _{CE}	Collector-emitter voltage	G-E Short	1200	V
V _{GE}	Gate-emitter voltage	C-E Short	±20	V
I _C	Collector current	DC, T _c = 81°C ^{*1}	150	A
I _{CM}		Pulse (Note 2)	300	
I _E (Note 1)	Emitter current		150	A
I _{EM} (Note 1)		Pulse (Note 2)	300	
P _C (Note 3)	Maximum collector dissipation	T _c = 25°C ^{*1}	960	W
T _j	Junction temperature		-40 ~ +150	°C
T _{stg}	Storage temperature		-40 ~ +125	°C
V _{iso}	Isolation voltage	Main terminal to base plate, AC 1 min.	2500	V
—	Torque strength	Main terminal M5	2.5 ~ 3.5	N • m
—		Mounting holes M6	3.5 ~ 4.5	
—	Weight	Typical value	310	g

ELECTRICAL CHARACTERISTICS (T_j = 25°C)

Symbol	Parameter	Test conditions	Limits			Unit
			Min.	Typ.	Max.	
I _{CE}	Collector cutoff current	V _{CE} = V _{CE} , V _{GE} = 0V	—	—	1	mA
V _{GE(th)}	Gate-emitter threshold voltage	I _C = 15mA, V _{CE} = 10V	6	7	8	V
I _{GE}	Gate leakage current	V _{GE} = V _{GE} , V _{CE} = 0V	—	—	0.5	μA
V _{CE(sat)}	Collector-emitter saturation voltage	T _j = 25°C	—	2.1	3.0	V
		T _j = 125°C	I _C = 150A, V _{GE} = 15V	—	2.4	
C _{ies}	Input capacitance	V _{CE} = 10V V _{GE} = 0V	—	—	23	nF
C _{oes}	Output capacitance		—	—	2	
C _{res}	Reverse transfer capacitance		—	—	0.45	
Q _G	Total gate charge	V _{CC} = 600V, I _C = 150A, V _{GE} = 15V	—	675	—	nC
t _{d(on)}	Turn-on delay time	V _{CC} = 600V, I _C = 150A V _{GE1} = V _{GE2} = 15V R _G = 2.1Ω, Inductive load switching operation I _E = 150A	—	—	130	ns
t _r	Turn-on rise time		—	—	100	
t _{d(off)}	Turn-off delay time		—	—	450	
t _f	Turn-off fall time		—	—	350	
t _{rr} (Note 1)	Reverse recovery time		—	—	150	
Q _{rr} (Note 1)	Reverse recovery charge		—	6.0	—	μC
V _{EC} (Note 1)	Emitter-collector voltage	I _E = 150A, V _{GE} = 0V	—	—	3.8	V
R _{th(j-c)Q}	Thermal resistance	IGBT part (1/2 module) ^{*1}	—	—	0.13	°C/W
R _{th(j-c)R}		FWDi part (1/2 module) ^{*1}	—	—	0.23	
R _{th(c-f)}	Contact thermal resistance	Case to fin, Thermal compound Applied (1/2 module) ^{*1,*2}	—	0.022	—	
R _G	External gate resistance		2.1	—	31	Ω

*1 : T_c, T_f measured point is just under the chips.

*2 : Typical value is measured by using Shin-etsu Silicone "G-746".

Note 1. I_E, V_{EC}, t_{rr} & Q_{rr} represent characteristics of the anti-parallel, emitter to collector free-wheel diode (FWDi).

2. Pulse width and repetition rate should be such that the device junction temp. (T_j) does not exceed T_{jmax} rating.

3. Junction temperature (T_j) should not increase beyond 150°C.

CM150DY-24A

HIGH POWER SWITCHING USE

PERFORMANCE CURVES

OUTPUT CHARACTERISTICS (TYPICAL)

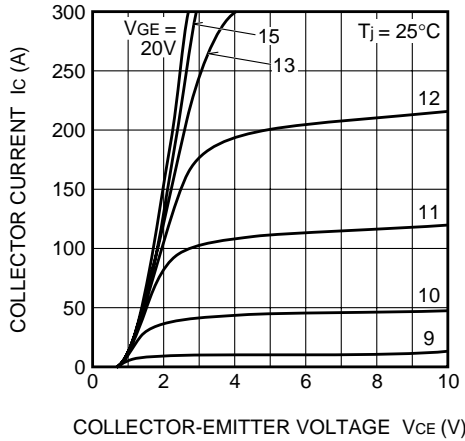

COLLECTOR-EMITTER SATURATION VOLTAGE CHARACTERISTICS (TYPICAL)

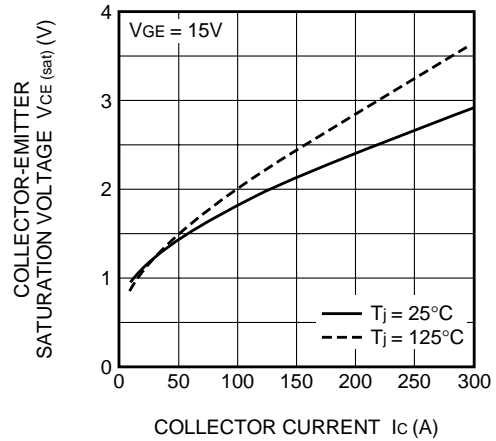

COLLECTOR-EMITTER SATURATION VOLTAGE CHARACTERISTICS (TYPICAL)

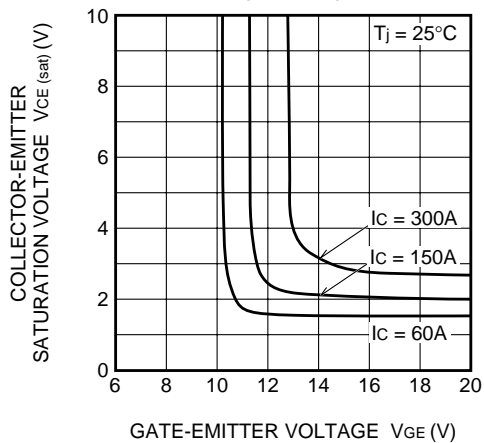

FREE-WHEEL DIODE FORWARD CHARACTERISTICS (TYPICAL)

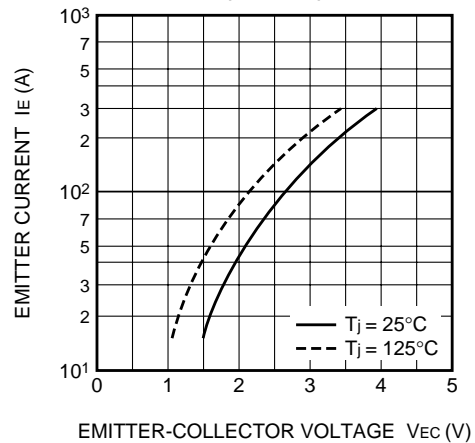

CAPACITANCE-VCE CHARACTERISTICS (TYPICAL)

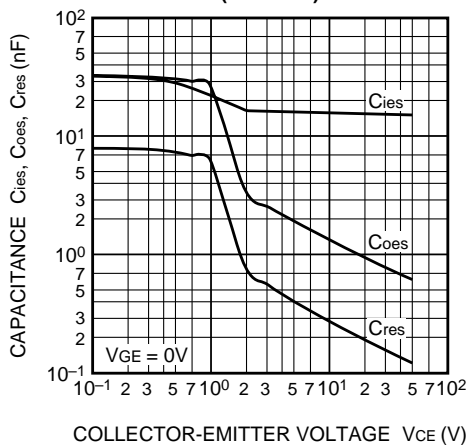

HALF-BRIDGE SWITCHING CHARACTERISTICS (TYPICAL)

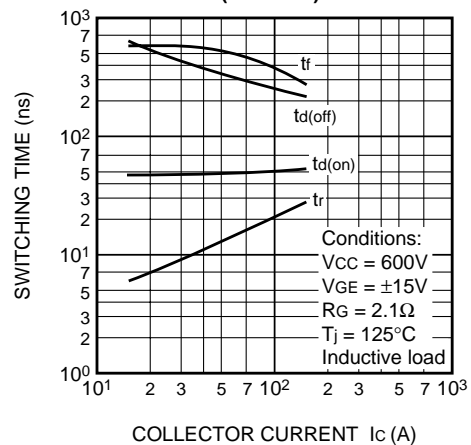

REVERSE RECOVERY CHARACTERISTICS OF FREE-WHEEL DIODE (TYPICAL)

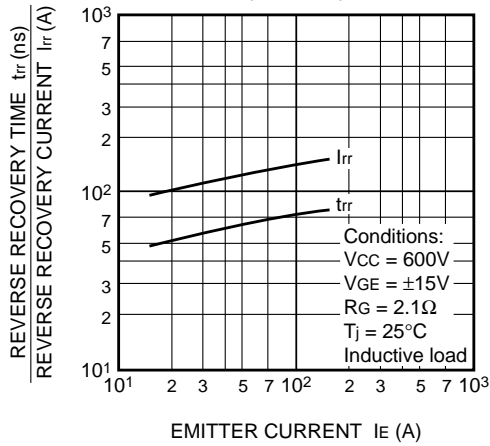

TRANSIENT THERMAL IMPEDANCE CHARACTERISTICS (IGBT part & FWDi part)

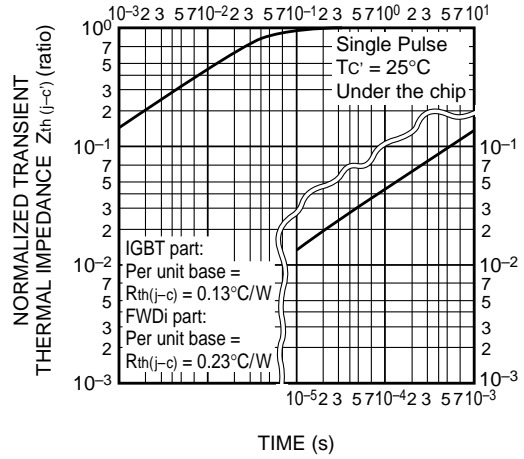

SWITCHING LOSS vs. COLLECTOR CURRENT (TYPICAL)

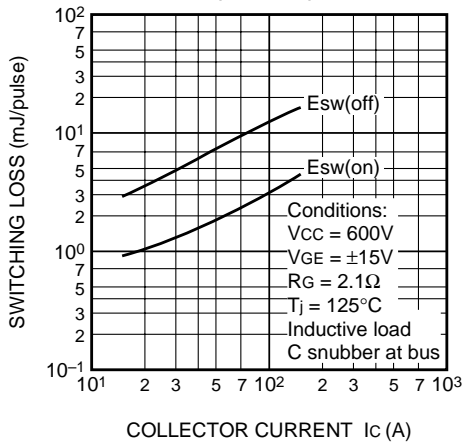

SWITCHING LOSS vs. GATE RESISTANCE (TYPICAL)

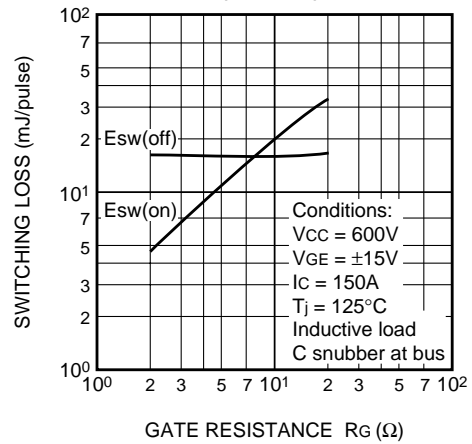

RECOVERY LOSS vs. IE (TYPICAL)

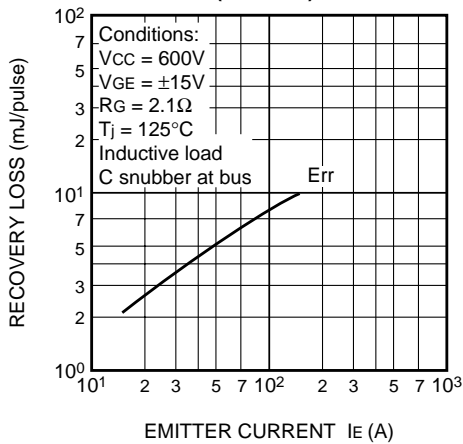

RECOVERY LOSS vs. GATE RESISTANCE (TYPICAL)

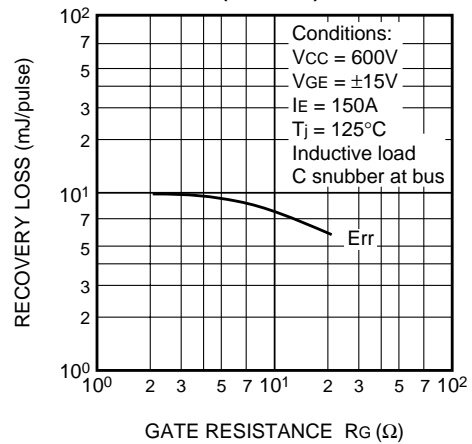

CM150DY-24A

HIGH POWER SWITCHING USE

