

Dual IGBTMOD™ H-Series Module 150 Amperes/1400 Volts

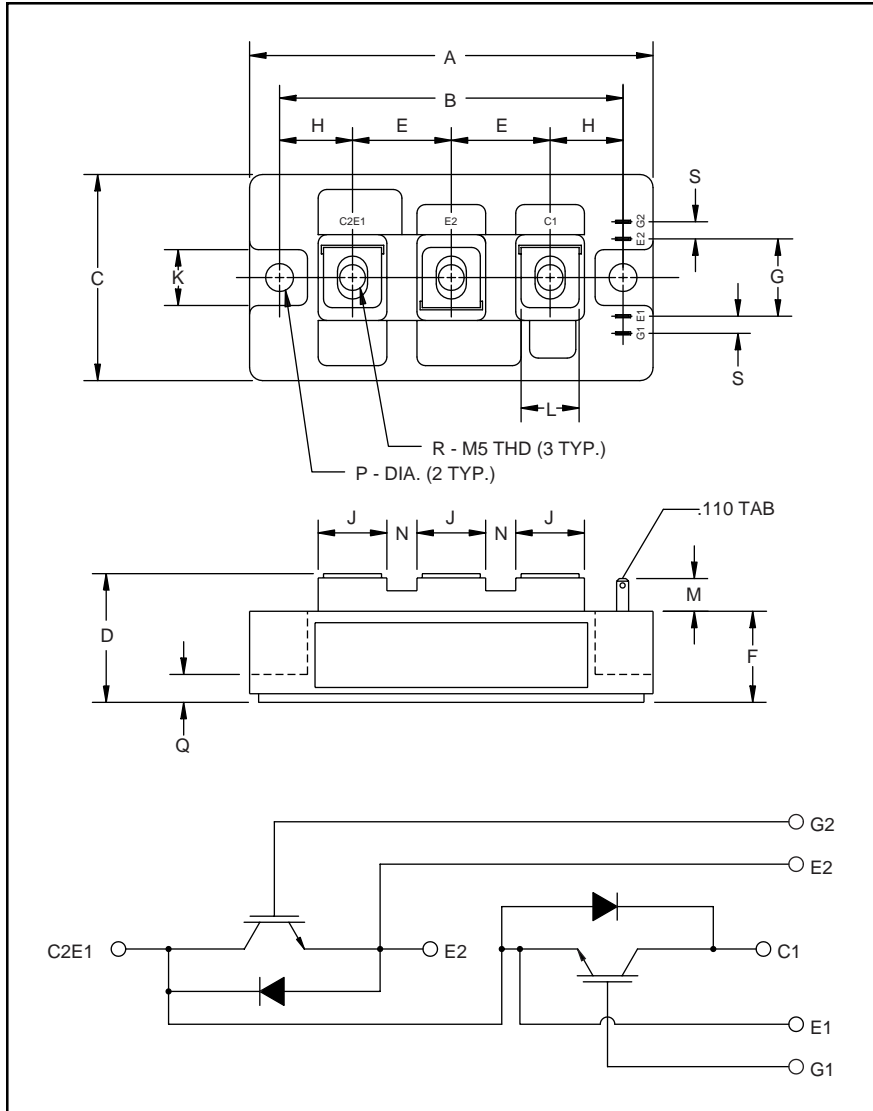

Outline Drawing and Circuit Diagram

Dimensions	Inches	Millimeters
A	3.70	94.0
B	3.150±0.01	80.0±0.25
C	1.89	48.0
D	1.18 Max.	30.0 Max.
E	0.90	23.0
F	0.83	21.2
G	0.71	18.0
H	0.67	17.0
J	0.63	16.0

Dimensions	Inches	Millimeters
K	0.51	13.0
L	0.47	12.0
M	0.30	7.5
N	0.28	7.0
P	0.256 Dia.	Dia. 6.5
Q	0.26	6.5
R	M5 Metric	M5
S	0.16	4.0



Description:

Powerex IGBTMOD™ Modules are designed for use in switching applications. Each module consists of two IGBT transistors in a half-bridge configuration with each transistor having a reverse-connected super-fast recovery free-wheel diode. All components and interconnects are isolated from the heat sinking baseplate, offering simplified system assembly and thermal management.

Features:

- Low Drive Power
- Low $V_{CE(sat)}$
- Discrete Super-Fast Recovery (135ns) Free Wheel Diode
- High Frequency Operation (20-25kHz)
- Isolated Baseplate for Easy Heat Sinking

Applications:

- AC Motor Control
- Motion/Servo Control
- UPS
- Welding Power Supplies
- Laser Power Supplies

Ordering Information:

Example: Select the complete part module number you desire from the table below -i.e. CM150DY-28H is a 1400V (V_{CES}), 150 Ampere Dual IGBTMOD™ Power Module.

Type	Current Rating Amperes	V_{CES} Volts (x 50)
CM	150	28



Powerex, Inc., 200 Hillis Street, Youngwood, Pennsylvania 15697-1800 (724) 925-7272

CM150DY-28H
Dual IGBTMOD™ H-Series Module
 150 Amperes/1400 Volts

Absolute Maximum Ratings, $T_j = 25\text{ }^\circ\text{C}$ unless otherwise specified

Ratings	Symbol	CM150DY-28H	Units
Junction Temperature	T_j	-40 to 150	$^\circ\text{C}$
Storage Temperature	T_{stg}	-40 to 125	$^\circ\text{C}$
Collector-Emitter Voltage (G-E SHORT)	V_{CES}	1400	Volts
Gate-Emitter Voltage (C-E SHORT)	V_{GES}	± 20	Volts
Collector Current	I_C	150	Amperes
Peak Collector Current	I_{CM}	300**	Amperes
Emitter Current	I_E^*	150	Amperes
Emitter Current-Pulse	I_{EM}^*	300**	Amperes
Maximum Collector Dissipation	P_C	1100***	Watts
Max. Mounting Torque M5 Terminal Screws	-	17	in-lb
Max. Mounting Torque M6 Mounting Screws	-	26	in-lb
Module Weight (Typical)	-	270	Grams
V Isolation	V_{RMS}	2500	Volts

* I_E , V_{EC} , T_{rr} , Q_{rr} & di_E/dt represent characteristics of the anti-parallel, emitter to collector free-wheel diode (FWDi).
 ** Pulse width and repetition rate should be such that the device junction temp. (T_j) does not exceed $T_{j(max)}$ rating.
 *** Junction temperature (T_j) should not increase beyond 150°C .

Static Electrical Characteristics, $T_j = 25\text{ }^\circ\text{C}$ unless otherwise specified

Characteristics	Symbol	Test Conditions	Min.	Typ.	Max.	Units
Collector-Cutoff Current	I_{CES}	$V_{CE} = V_{CES}$, $V_{GE} = 0V$	-	-	1.0	mA
Gate Leakage Current	I_{GES}	$V_{GE} = V_{GES}$, $V_{CE} = 0V$	-	-	0.5	μA
Gate-Emitter Threshold Voltage	$V_{GE(th)}$	$I_C = 15\text{mA}$, $V_{CE} = 10V$	5.0	6.5	8.0	Volts
Collector-Emitter Saturation Voltage	$V_{CE(sat)}$	$I_C = 150\text{A}$, $V_{GE} = 15V$	-	3.1	4.2*	Volts
		$I_C = 150\text{A}$, $V_{GE} = 15V$, $T_j = 125^\circ\text{C}$	-	2.95	-	Volts
Total Gate Charge	Q_G	$V_{CC} = 800V$, $I_C = 150\text{A}$, $V_{GE} = 15V$	-	765	-	nC

* Pulse width and repetition rate should be such that device junction temperature rise is negligible.

Dynamic Electrical Characteristics, $T_j = 25\text{ }^\circ\text{C}$ unless otherwise specified

Characteristics	Symbol	Test Conditions	Min.	Typ.	Max.	Units	
Input Capacitance	C_{ies}		-	-	30	nF	
Output Capacitance	C_{Oes}	$V_{GE} = 0V$, $V_{CE} = 10V$	-	-	10.5	nF	
Reverse Transfer Capacitance	C_{res}		-	-	6	nF	
Resistive	Turn-on Delay Time	$V_{CC} = 800V$, $I_C = 150\text{A}$, $V_{GE1} = V_{GE2} = 15V$, $R_G = 2.1\Omega$	-	-	250	ns	
Load	Rise Time		t_r	-	-	400	ns
Switching	Turn-off Delay Time		$t_{d(off)}$	-	-	300	ns
Times	Fall Time		-	-	500	ns	
Diode Reverse Recovery Time	t_{rr}	$I_E = 150\text{A}$, $di_E/dt = -300\text{A}/\mu\text{s}$	-	-	300	ns	
Emitter-Collector Voltage	V_{EC}	$I_E = 150\text{A}$, $V_{GE} = 0V$	-	-	3.8	V	
Diode Reverse Recovery Charge	Q_{rr}	$I_E = 150\text{A}$, $di_E/dt = -300\text{A}/\mu\text{s}$	-	1.5	-	μC	

Thermal and Mechanical Characteristics, $T_j = 25\text{ }^\circ\text{C}$ unless otherwise specified

Characteristics	Symbol	Test Conditions	Min.	Typ.	Max.	Units
Thermal Resistance, Junction to Case	$R_{th(j-c)}$	Per IGBT	-	-	0.11	$^\circ\text{C}/\text{W}$
Thermal Resistance, Junction to Case	$R_{th(j-c)}$	Per FWDi	-	-	0.24	$^\circ\text{C}/\text{W}$
Contact Thermal Resistance	$R_{th(c-f)}$	Per Module, Thermal Grease Applied	-	-	0.13	$^\circ\text{C}/\text{W}$

CM150DY-28H
Dual IGBTMOD™ H-Series Module
 150 Amperes/1400 Volts

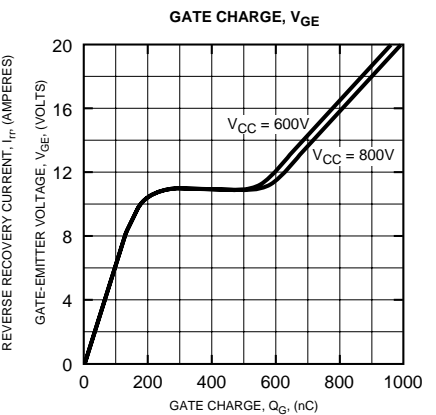
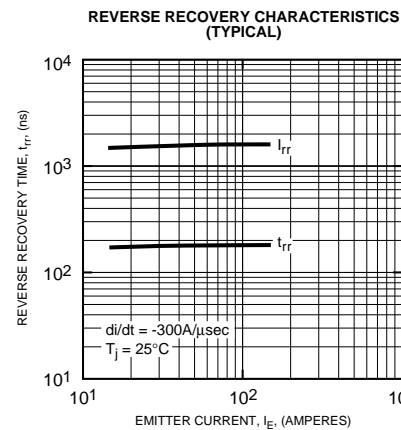
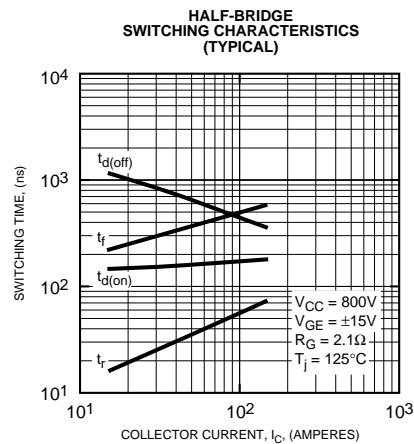
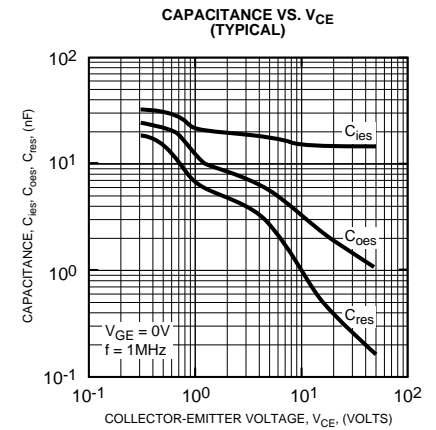
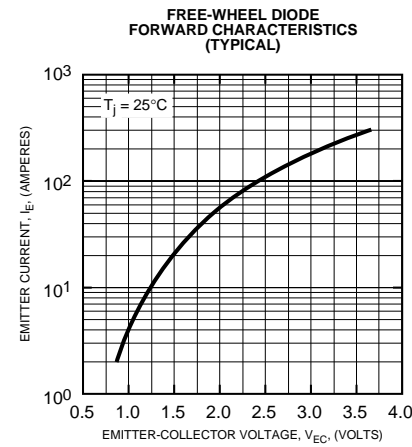
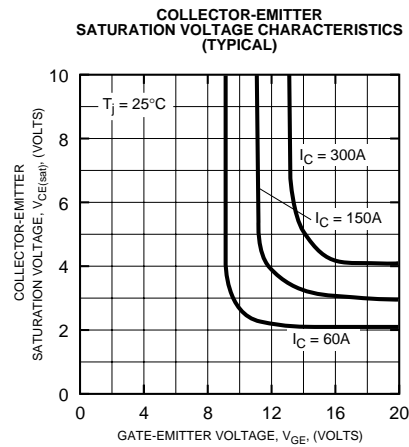
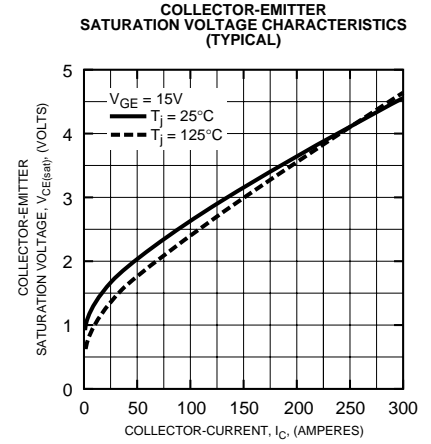
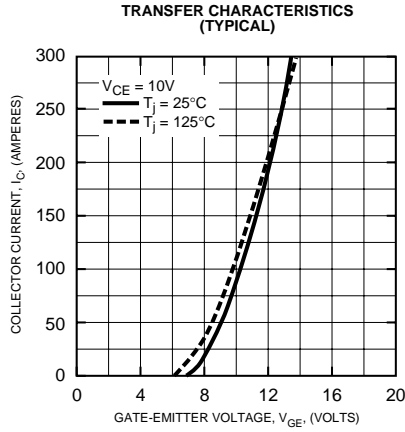
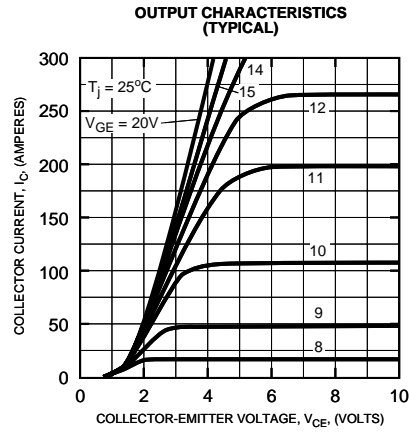



Powerex, Inc., 200 Hillis Street, Youngwood, Pennsylvania 15697-1800 (724) 925-7272

CM150DY-28H
Dual IGBTMOD™ H-Series Module
150 Amperes/1400 Volts

