

CT30SM-12

GENERAL INVERTER • UPS USE

CT30SM-12



- VCES 600V
- IC 30A
- High Speed Switching
- Low VCE Saturation Voltage

OUTLINE DRAWING

Dimensions in mm

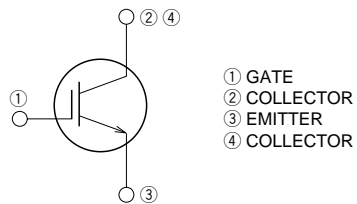
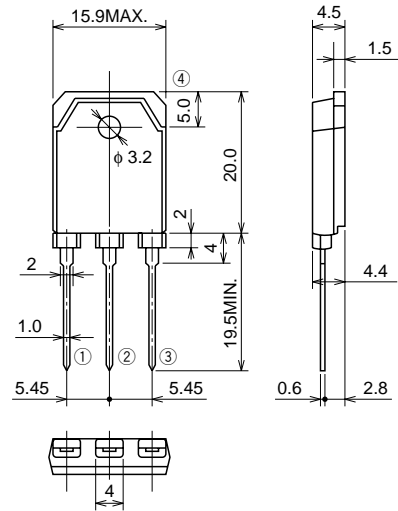

TO-3P

APPLICATION

AC & DC motor controls, General purpose inverters, UPS, Power supply switching, Servo controls, etc.

MAXIMUM RATINGS (Tc = 25°C)

Symbol	Parameter	Conditions	Ratings	Unit
V _{CE} S	Collector-emitter voltage	V _{GE} = 0V	600	V
V _{GES}	Gate-emitter voltage	V _{CE} = 0V	±20	V
V _{GEM}	Peak gate-emitter voltage	V _{CE} = 0V	±30	V
I _C	Collector current		30	A
I _{CM}	Collector current (Pulsed)		60	A
P _C	Maximum power dissipation		250	W
T _j	Junction temperature		-40 ~ +150	°C
T _{stg}	Storage temperature		-40 ~ +150	°C
—	Weight	Typical value	4.8	g

ELECTRICAL CHARACTERISTICS ($T_j = 25^\circ\text{C}$)

Symbol	Parameter	Test conditions	Limits			Unit
			Min.	Typ.	Max.	
V (BR) CES	Collector-emitter breakdown voltage	$I_C = 1\text{mA}, V_{GE} = 0\text{V}$	600	—	—	V
IGES	Collector-emitter leakage current	$V_{GE} = \pm 30\text{V}, V_{CE} = 0\text{V}$	—	—	± 0.5	μA
ICES	Gate-emitter leakage current	$V_{CE} = 600\text{V}, V_{GE} = 0\text{V}$	—	—	1	mA
$V_{GE(th)}$	Gate-emitter threshold voltage	$I_C = 3.0\text{mA}, V_{CE} = 10\text{V}$	4.5	6.0	7.5	V
$V_{CE(sat)}$	Collector-emitter saturation voltage	$I_C = 30\text{A}, V_{GE} = 15\text{V}$	—	2.5	3.0	V
C_{ies}	Input capacitance	$V_{CE} = 25\text{V}, V_{GE} = 0\text{V}, f = 1\text{MHz}$	—	1480	—	pF
C_{oes}	Output capacitance		—	180	—	pF
C_{res}	Reverse transfer capacitance		—	54	—	pF
$t_d(on)$	Turn-on delay time	$V_{CC} = 300\text{V}, \text{Resistance load}, I_C = 30\text{A}, V_{GE} = 15\text{V}, R_{GE} = 20\Omega$	—	30	—	ns
t_r	Rise time		—	135	—	ns
$t_d(off)$	Turn-off delay time		—	135	—	ns
t_f	Fall time		—	250	—	ns
$R_{th(j-c)}$	Thermal resistance	Junction to case	—	—	0.50	$^\circ\text{C/W}$

PERFORMANCE CURVES

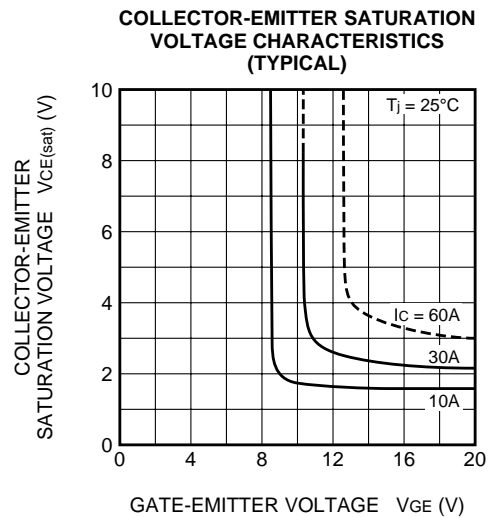
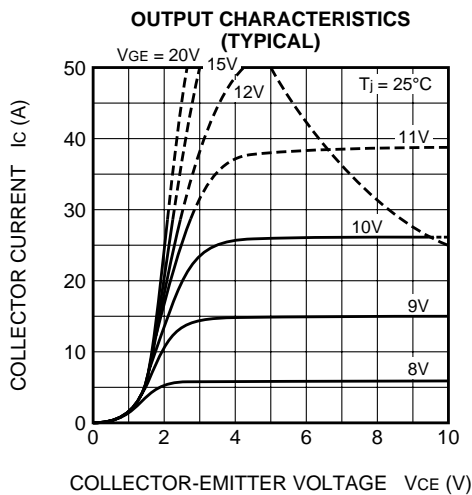

COLLECTOR-EMITTER SATURATION VOLTAGE CHARACTERISTICS (TYPICAL)

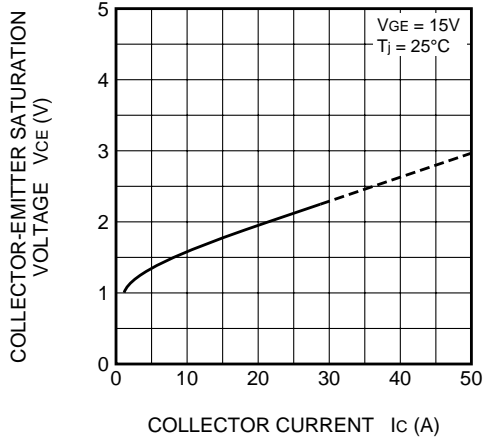

COLLECTOR CURRENT VS. GATE-EMITTER VOLTAGE CHARACTERISTIC (TYPICAL)

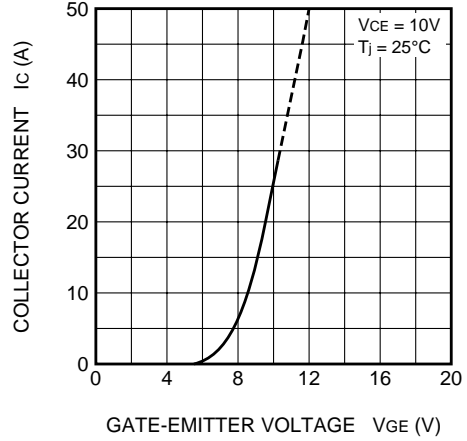

CAPACITANCE VS. COLLECTOR-EMITTER VOLTAGE CHARACTERISTIC (TYPICAL)

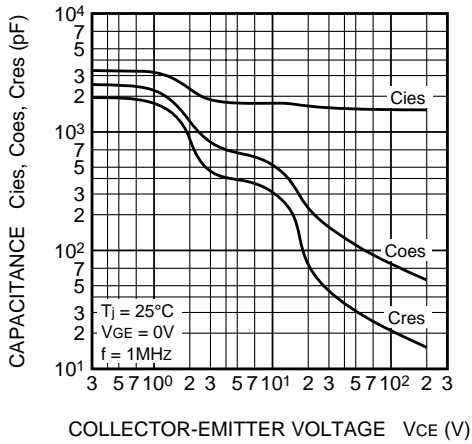

SWITCHING TIME-COLLECTOR CURRENT CHARACTERISTIC (TYPICAL)

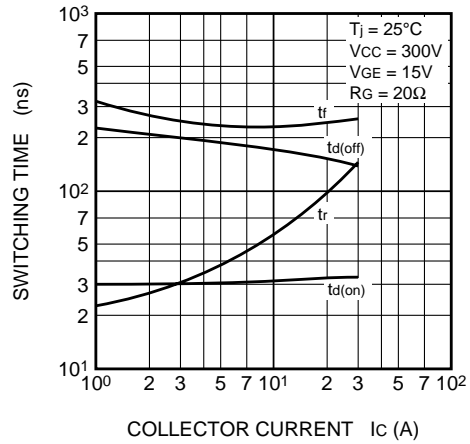

GATE-EMITTER VOLTAGE VS. GATE CHARGE CHARACTERISTIC (TYPICAL)

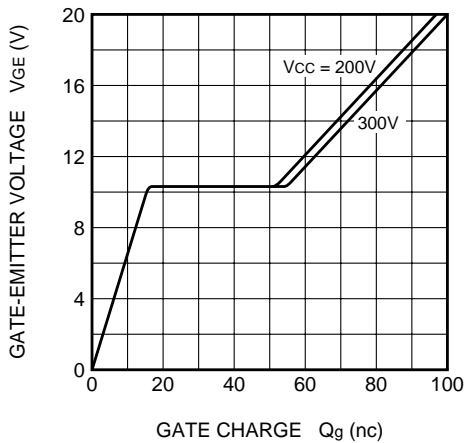

TRANSIENT THERMAL IMPEDANCE CHARACTERISTICS (TYPICAL)

