



# HIGH POWER NPN POWER DARLINGTON TRANSISTORS

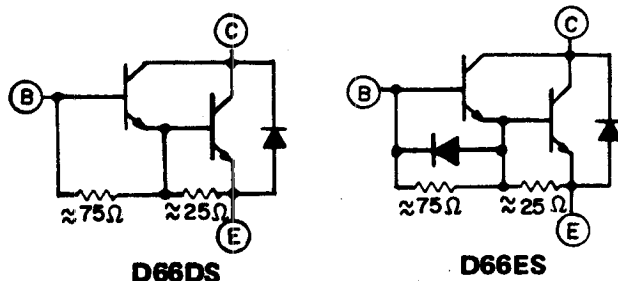
**D66DS5,6,7  
D66ES5,6,7**

**500-700 VOLTS  
20 AMP, 62.5 WATTS**

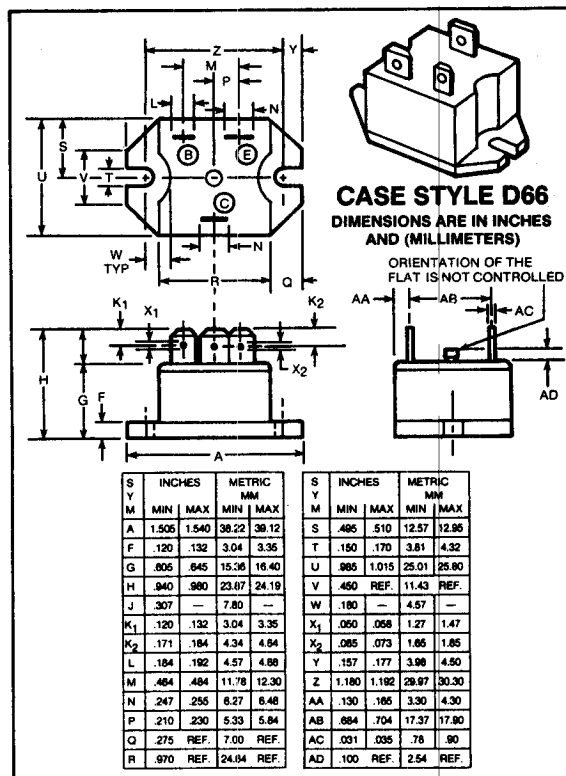
The General Electric D66DS/D66ES are high current power darlington transistors. They feature collector isolation from the heat sink, an internal construction designed for stress-free operation at temperature extremes and quick connect electrical terminals. The devices are designed to meet UL creep, strike and isolation voltage. Major applications are for motor controls, switching power supplies, and UPS systems. The D66ES has a speed-up diode, the D66DS does not.

### Features:

- High Voltage: 400-500 V<sub>CEO</sub>
- High Current: 30 Amperes, I<sub>C</sub> (Peak)
- High Gain: h<sub>FE</sub> 40 Minimum @ 20 Amperes, I<sub>C</sub>



**DEVICE CIRCUIT**



maximum ratings (T<sub>C</sub> = 25° C) (unless otherwise noted)

RATING	SYMBOL	D66DS5/ES5	D66DS6/ES6	D66DS7/ES7	UNITS
Collector-Emitter Voltage	V <sub>CEV</sub>	500	600	700	Volts
Collector-Emitter Voltage	V <sub>CEO</sub>	400	450	500	Volts
Emitter Base Voltage	V <sub>EBO</sub>	8	8	8	Volts
		5	5	5	
Collector Current — Continuous	I <sub>C</sub>	20	20	20	A
Peak (Repetitive)	I <sub>CM</sub>	30	30	30	
Peak (Non-Repetitive)	I <sub>CSM</sub>	50	50	50	
Base Current — Continuous	I <sub>B</sub>	5	5	5	A
Peak (Non-Repetitive)	I <sub>BM</sub>	10	10	10	
Total Power Dissipation @ T <sub>C</sub> = 25° C	P <sub>D</sub>	62.5	62.5	62.5	Watts
Operating and Storage Junction Temperature Range	T <sub>J</sub> , T <sub>STG</sub>	-40 to +150	-40 to +150	-40 to +150	°C
Isolation Voltage	V <sub>ISOL</sub>	2500	2500	2500	V <sub>(rms)</sub>

### thermal characteristics

Thermal Resistance, Junction to Case	R <sub>θJC</sub>	2	2	2	°C/W
--------------------------------------	------------------	---	---	---	------

See page 845 for mounting and handling considerations.

electrical characteristics ( $T_C = 25^\circ\text{C}$ ) (unless otherwise specified)

CHARACTERISTIC	SYMBOL	MIN	TYP	MAX	UNIT
----------------	--------	-----	-----	-----	------

off characteristics

Collector-Emitter Sustaining Voltage ( $I_C = .5\text{A}$ ) ( $V_{\text{clamp}} = V_{\text{CEO Rated}}$ )	D66DS5/ES5 D66DS6/ES6 D66DS7/ES7	$V_{\text{CEO(sus)}}$	400 450 500	— — —	— — —	Volts
Collector Cutoff Current ( $V_{\text{CE}} = \text{Rated Value}$ , $V_{\text{BE}} = -1.5\text{V}$ )	$T_J = 25^\circ\text{C}$ $T_J = 150^\circ\text{C}$	$I_{\text{CEV}}$	— —	— —	1.0 2.5	mA
Emitter Cutoff Current ( $V_{\text{EB}} = 4.5\text{V}$ , $I_C = 0$ ) ( $V_{\text{EB}} = 1.5\text{V}$ , $I_C = 0$ )	D66DS D66ES	$I_{\text{EBO}}$	— —	— —	200 200	mA

second breakdown

Second Breakdown with Base Forward Biased	FBSOA	SEE FIGURE 26
---	-------	---------------

on characteristics

DC Current Gain ( $I_C = 30\text{A}$ , $V_{\text{CE}} = 5\text{V}$ ) ( $I_C = 20\text{A}$ , $V_{\text{CE}} = 5\text{V}$ ) ( $I_C = 10\text{A}$ , $V_{\text{CE}} = 5\text{V}$ )	$h_{\text{FE}}$	20 40 100	35 85 160	— — —	—
Collector-Emitter Saturation Voltage ( $I_C = 30\text{A}$ , $I_B = 3\text{A}$ ) ( $I_C = 20\text{A}$ , $I_B = 2\text{A}$ ) ( $I_C = 10\text{A}$ , $I_B = 1\text{A}$ )	$V_{\text{CE(sat)}}$	— — —	2.1 1.6 1.2	3.5 2.5 1.7	V
Base-Emitter Saturation Voltage ( $I_C = 30\text{A}$ , $I_B = 3\text{A}$ ) ( $I_C = 20\text{A}$ , $I_B = 2\text{A}$ ) ( $I_C = 10\text{A}$ , $I_B = 1\text{A}$ )	$V_{\text{BE(sat)}}$	— — —	2.65 2.30 1.80	4 3 2.5	V

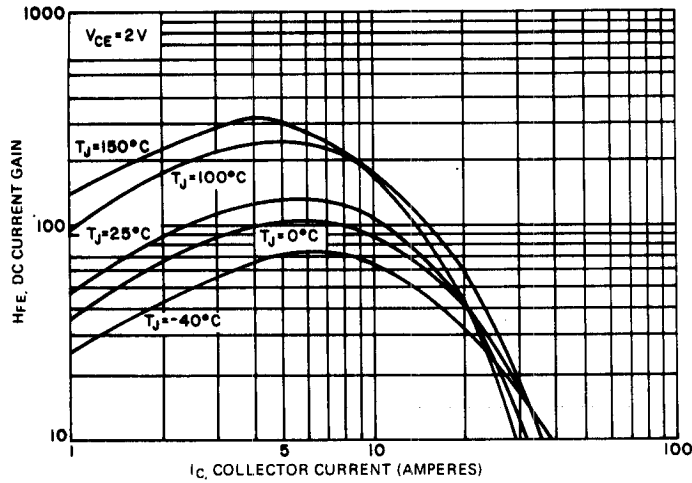
switching characteristics

		TYP.		MAX.		
Resistive Load		DS	ES	DS	ES	
Delay Time	$V_{\text{CC}} = 250\text{V}$	—	.05	.05	0.5	$\mu\text{s}$
Rise Time	$I_C = 20\text{A}$	—	.4	.4	1	
Storage Time	$I_{\text{B1}} = 1\text{A}$ , $I_{\text{B2}} = 2\text{A}$	—	2.2	1.8	5	
Fall Time	$t_p = 50 \mu\text{sec}$	—	1.6	.45	3	

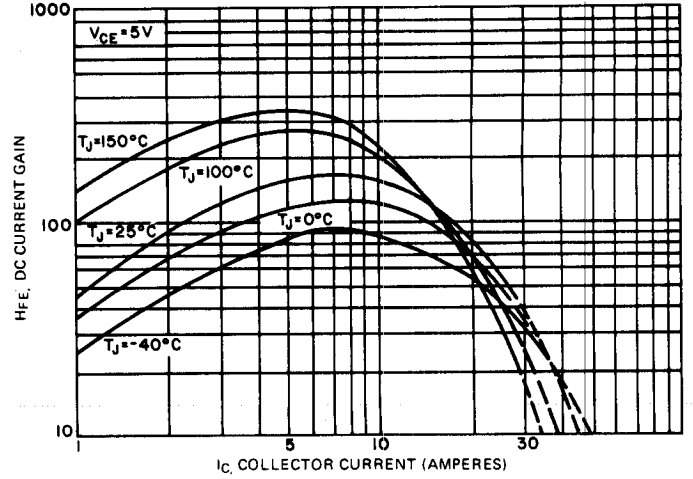
emitter-collector diode characteristics

Power Dissipation ( $I_{\text{B1}} = 0$ )	$P_D$	—	—	62.5	Watts
Forward Voltage ( $I_F = 10\text{A}$ ) ( $I_P = 25\text{A}$ ) ( $I_F = 25\text{A}$ , $T_J = 150^\circ\text{C}$ )	$V_F$ $V_F$ $V_F$	— — —	1.95 2.80 2.75	3.20 4.00 4.00	Volts Volts Volts
Reverse Recovery Time ( $I_F = 25\text{A}$ , $di/dt = 10\text{A}/\mu\text{sec}$ , $R_{\text{B1E}} = .25\Omega$ )	$T_{\text{rr}}$	—	3.85	10	$\mu\text{sec}$
Forward Turn-On Time ( $I_F = 25\text{A}$ , $di/dt = 50\text{A}/\mu\text{sec}$ )	$T_{\text{ON}}$	—	0.42	1.0	$\mu\text{sec}$
Single Cycle Surge Current (60Hz)	$I_{\text{FSM}}$	—	—	50	Amps
Thermal Resistance	$R_{\theta\text{JC}}$	—	—	2.0	$^\circ\text{C}/\text{Watt}$

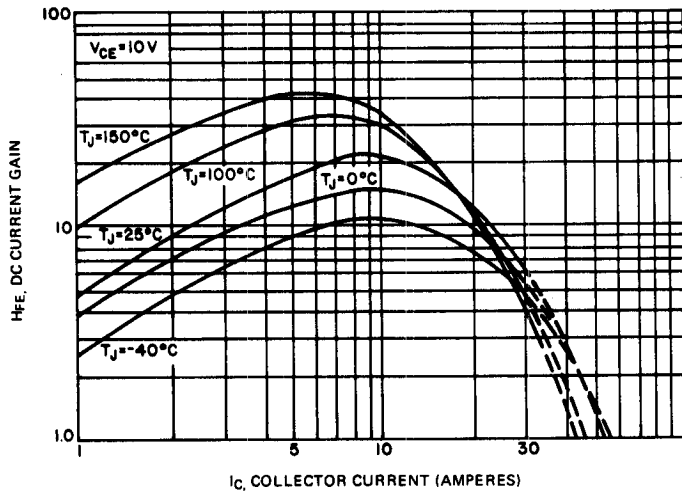
## TYPICAL CHARACTERISTICS



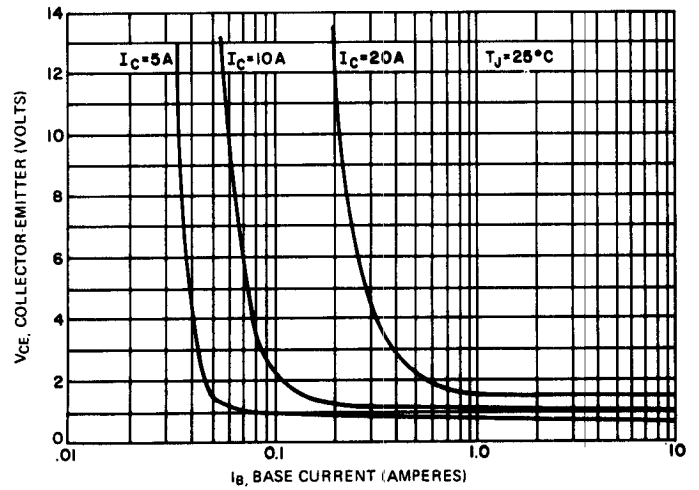
**FIGURE 1. DC CURRENT GAIN ( $V_{CE} = 2V$ )**



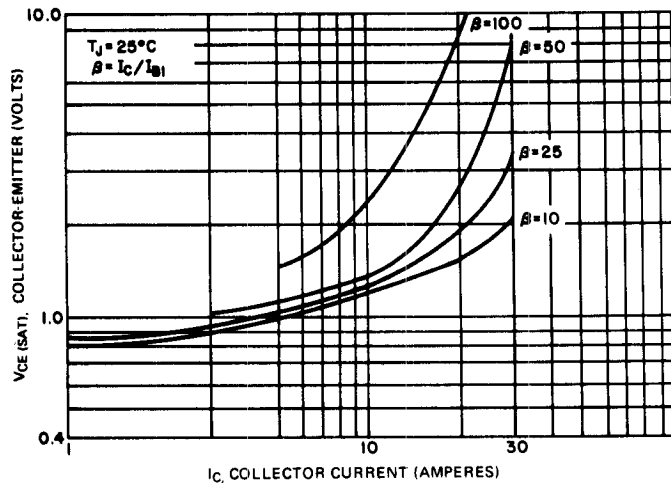
**FIGURE 2. DC CURRENT GAIN ( $V_{CE} = 5V$ )**



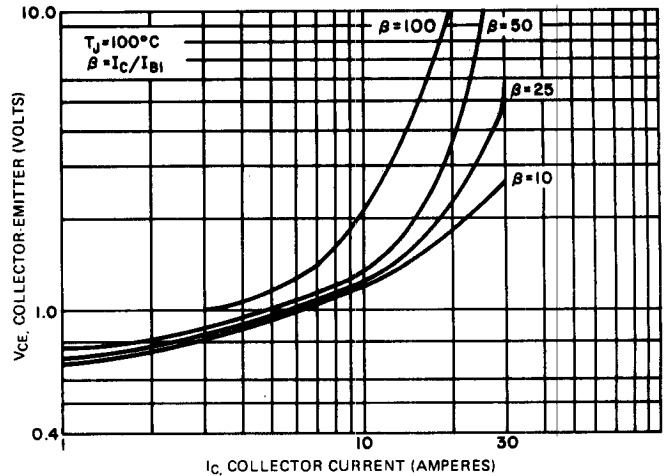
**FIGURE 3. DC CURRENT GAIN ( $V_{CE} = 10V$ )**



**FIGURE 4. COLLECTOR SATURATION REGION**



**FIGURE 5.  $V_{CE(SAT)}$  VS.  $I_C$ ,  $T_J = 25^\circ C$**



**FIGURE 6.  $V_{CE(SAT)}$  VS.  $I_C$ ,  $T_J = 100^\circ C$**

# TYPICAL CHARACTERISTICS

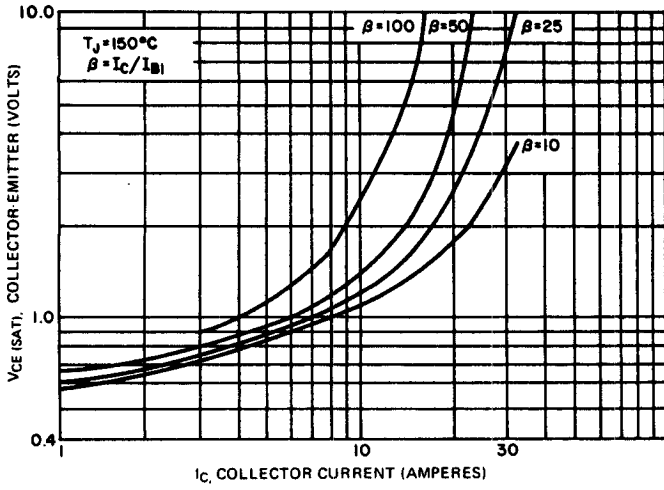


FIGURE 7.  $V_{CE(SAT)}$  VS.  $I_C$ ,  $T_J = 150^\circ\text{C}$

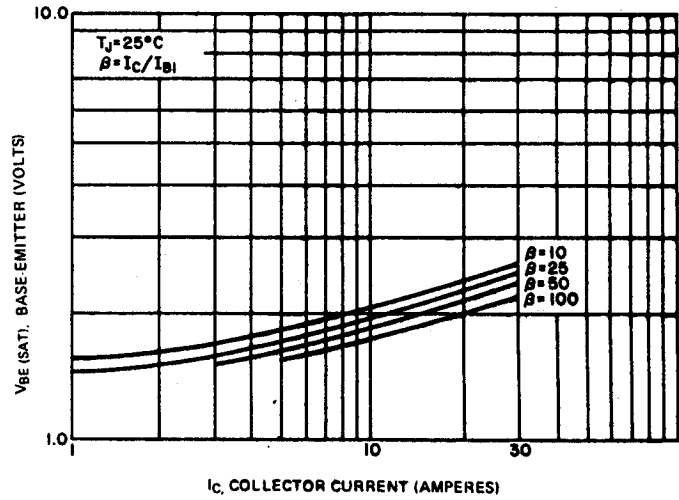


FIGURE 8.  $V_{BE(SAT)}$  VS.  $I_C$ ,  $T_J = 25^\circ\text{C}$

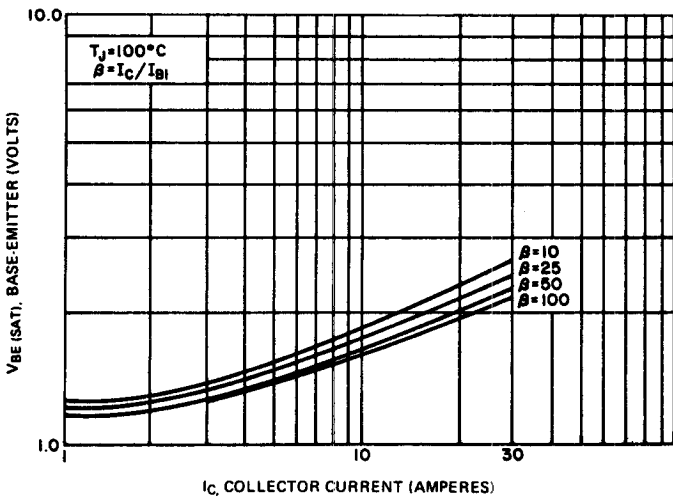


FIGURE 9.  $V_{BE(SAT)}$  VS.  $I_C$ ,  $T_J = 100^\circ\text{C}$

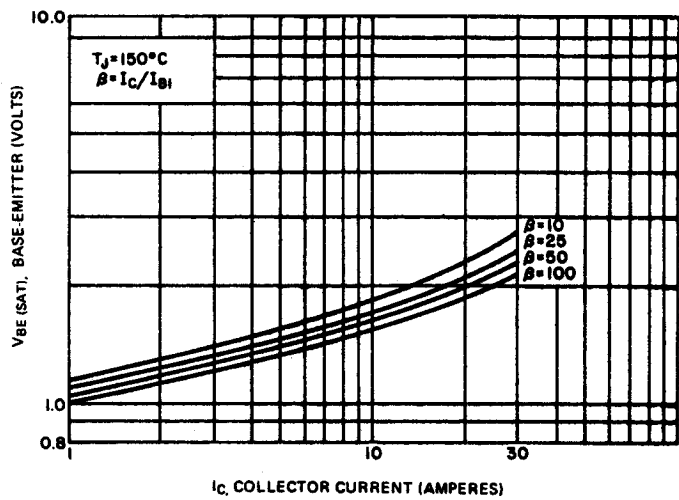


FIGURE 10.  $V_{BE(SAT)}$  VS.  $I_C$ ,  $T_J = 150^\circ\text{C}$

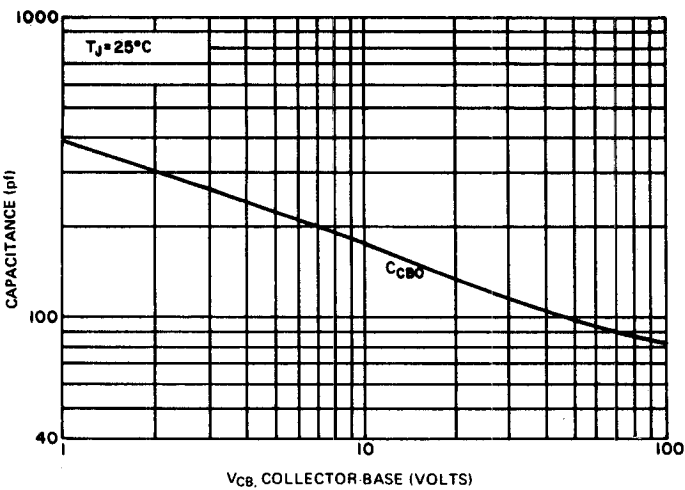


FIGURE 11. CAPACITANCE ( $C_{CB0}$ )

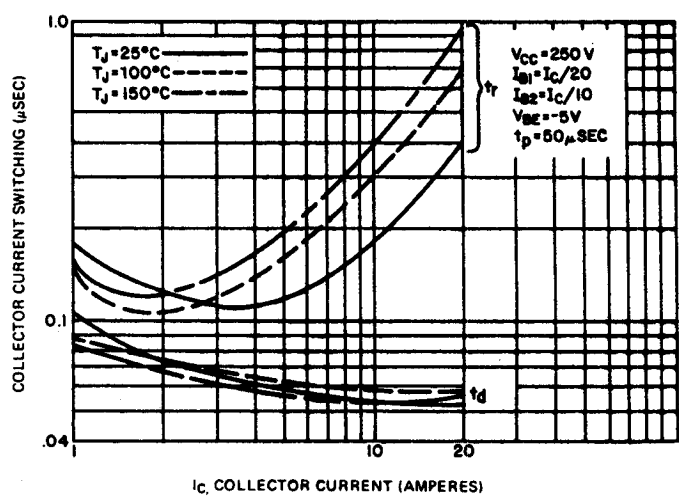
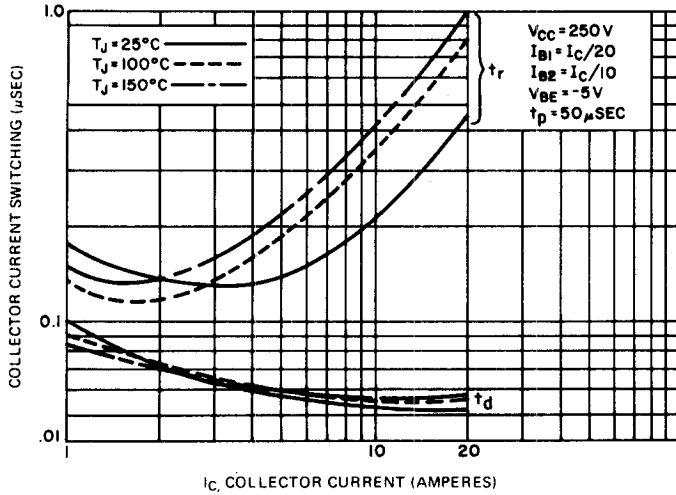
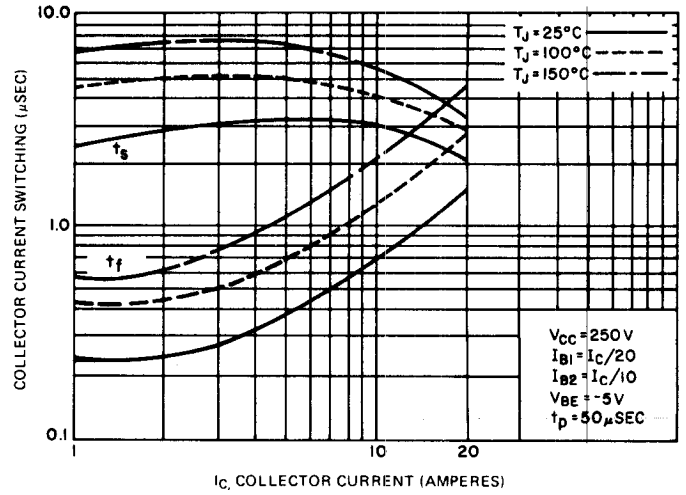


FIGURE 12. TURN-ON TIME (RESISTIVE LOAD) (D66DS ONLY)

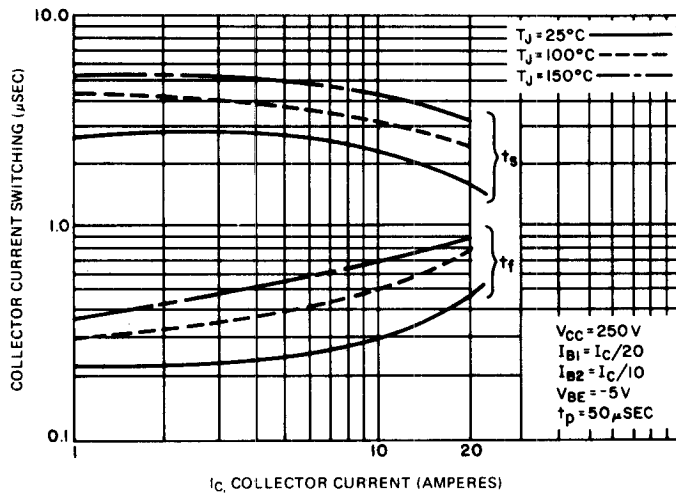
## TYPICAL CHARACTERISTICS



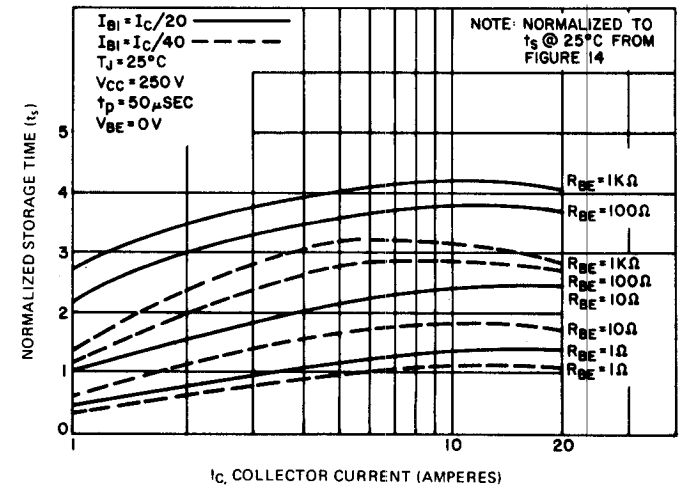
**FIGURE 13. TURN-ON TIME (RESISTIVE)  
(D66ES ONLY)**



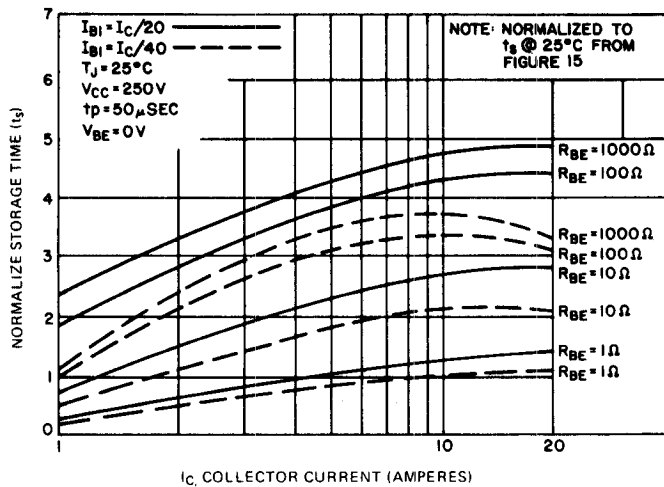
**FIGURE 14. TURN-OFF TIME (RESISTIVE)  
(D66DS ONLY)**



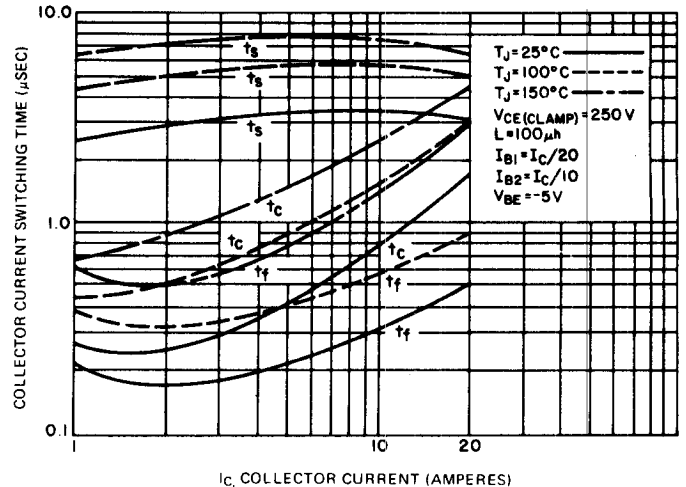
**FIGURE 15. TURN-OFF TIME (RESISTIVE)  
(D66ES ONLY)**



**FIGURE 16. NORMALIZED RESISTIVE  
SWITCHING STORAGE TIME ( $R_{BE}$  VARIATIONS)  
VS. COLLECTOR CURRENT  
(D66DS ONLY)**

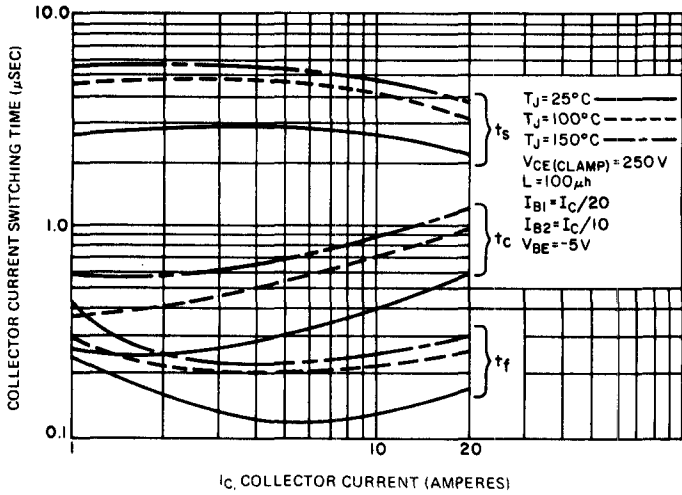


**FIGURE 17. NORMALIZED RESISTIVE  
SWITCHING STORAGE TIME ( $R_{BE}$  VARIATIONS)  
VS. COLLECTOR CURRENT  
(D66ES ONLY)**

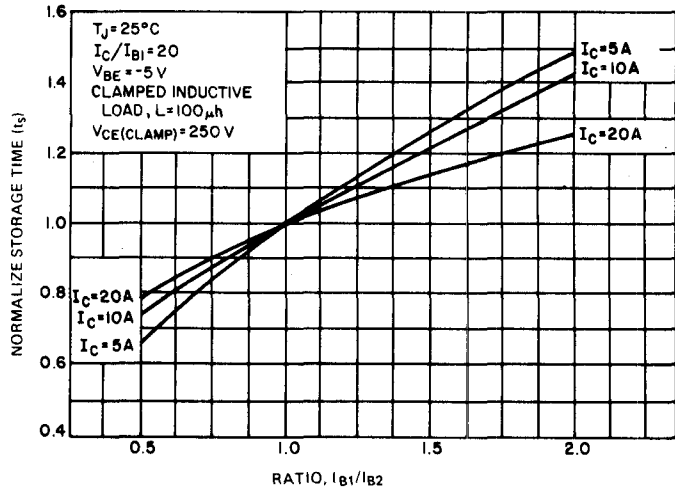


**FIGURE 18. CLAMPED INDUCTIVE  
TURN-OFF TIME  
(D66DS ONLY)**

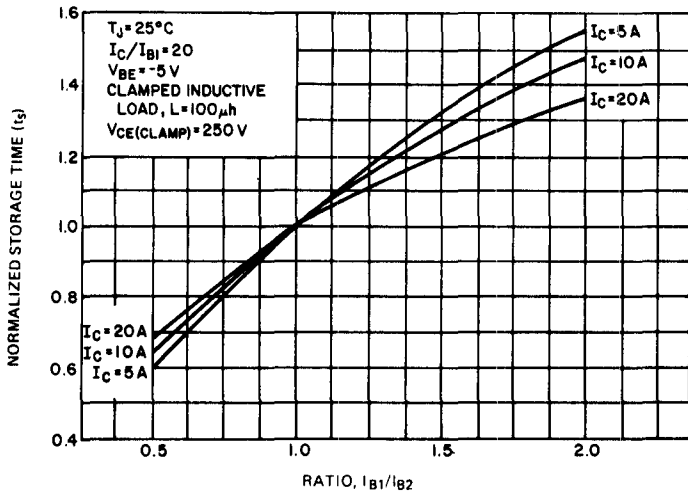
## TYPICAL CHARACTERISTICS



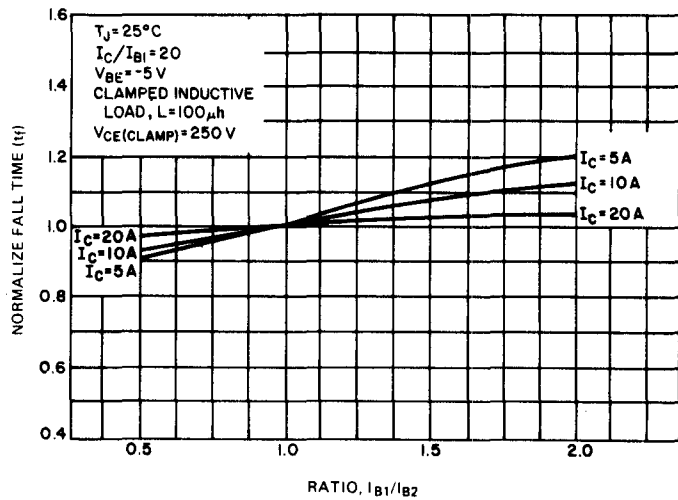
**FIGURE 19. CLAMPED INDUCTIVE TURN-OFF TIME (D66ES ONLY)**



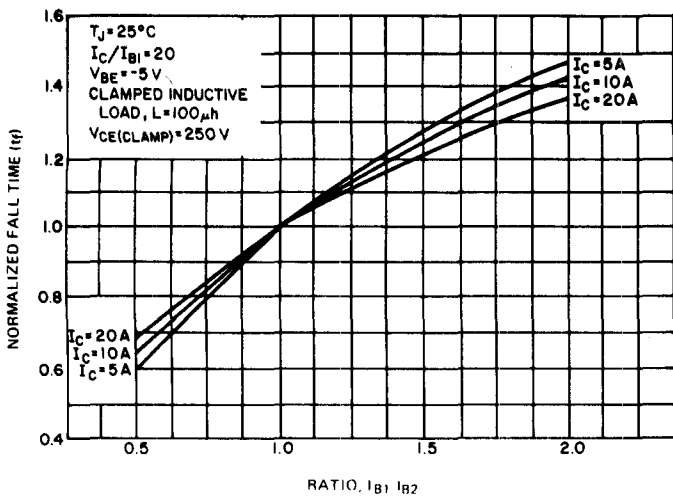
**FIGURE 20. STORAGE TIME VARIATION WITH  $I_{B2}$  (D66DS ONLY)**



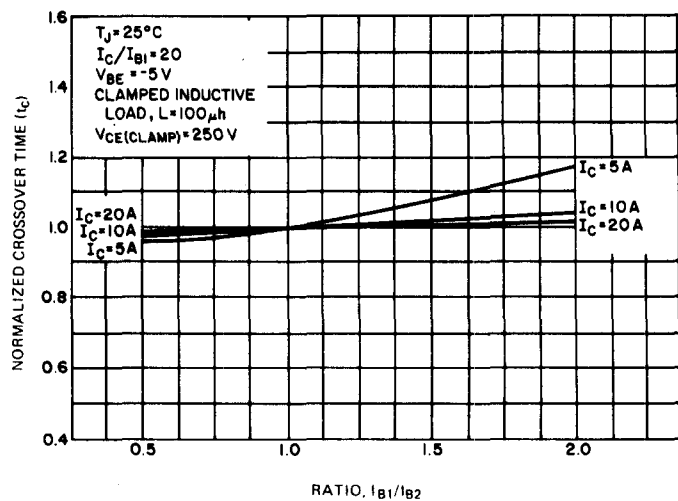
**FIGURE 21. STORAGE TIME VARIATION WITH  $I_{B2}$  (D66ES ONLY)**



**FIGURE 22. FALL TIME VARIATION WITH  $I_{B2}$  (D66DS ONLY)**

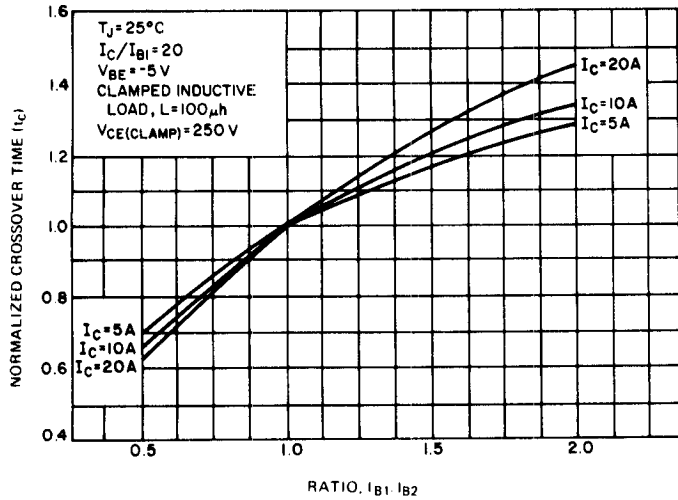


**FIGURE 23. FALL TIME VARIATION WITH  $I_{B2}$  (D66ES ONLY)**

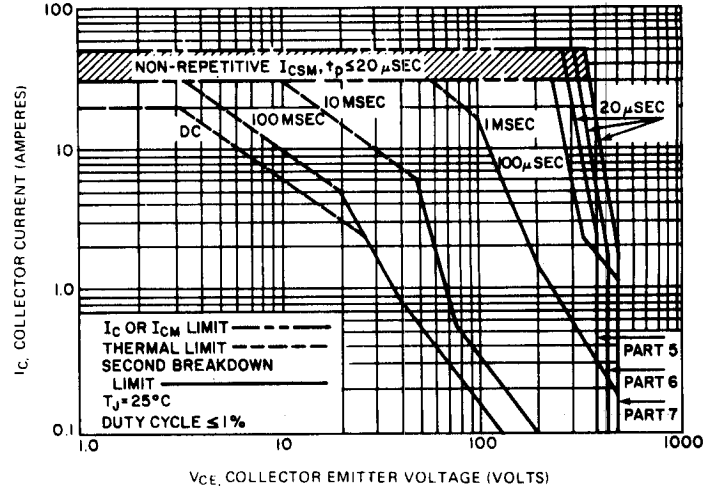


**FIGURE 24. CROSS-OVER TIME VARIATION WITH  $I_{B2}$  (D66DS ONLY)**

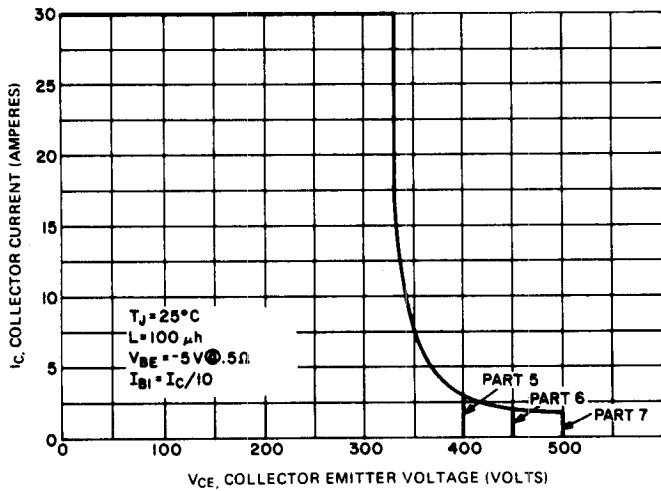
## TYPICAL CHARACTERISTICS



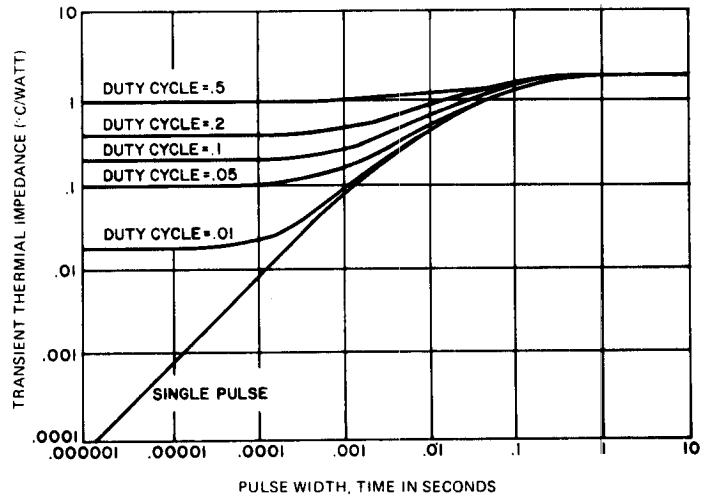
**FIGURE 25. CROSS-OVER TIME VARIATION WITH  $I_{B2}$  (D66ES ONLY)**



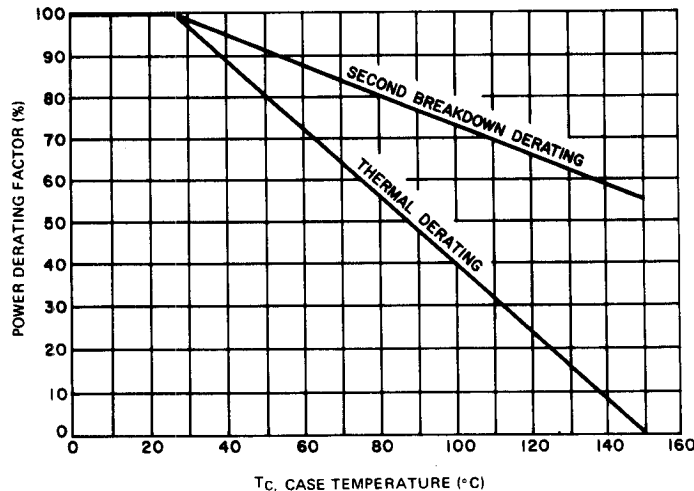
**FIGURE 26. FORWARD BIAS SAFE OPERATING AREA**



**FIGURE 27. REVERSE BIAS SAFE OPERATING AREA**



**FIGURE 28. TRANSIENT THERMAL RESPONSE**



**FIGURE 29. POWER DERATING**

# TYPICAL CHARACTERISTICS

## DIODE CHARACTERISTICS

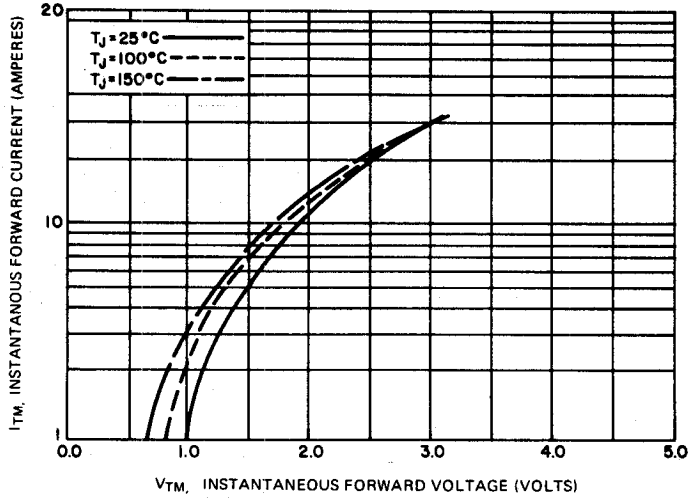


FIGURE 30. FORWARD CHARACTERISTICS

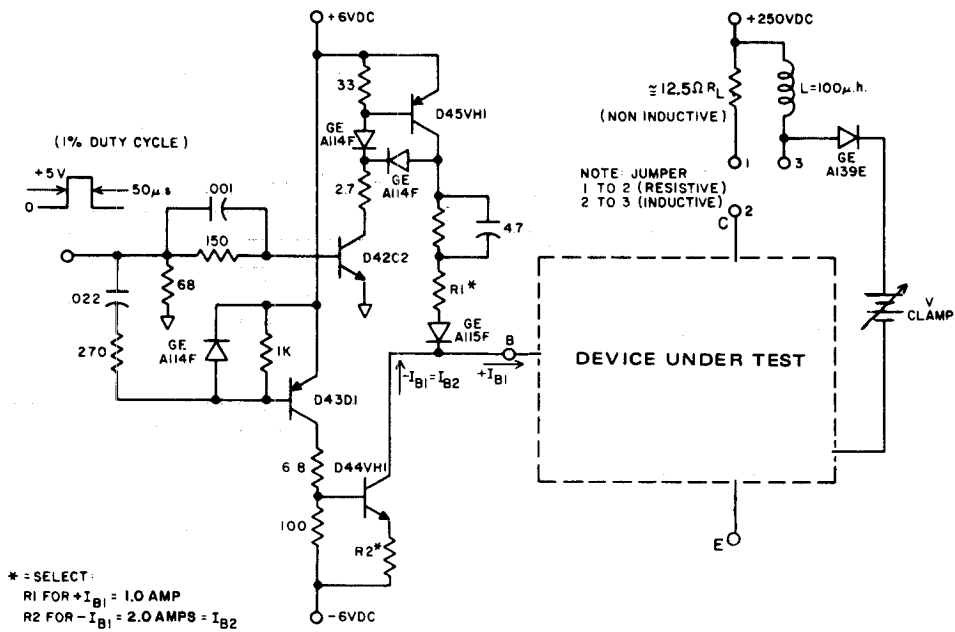


FIGURE 31. SWITCHING TIME TEST CIRCUIT