

DIODE MODULE (F.R.D.)

FDF60BA50/60



UL;E76102 (M)

Power Diode Module **FDF60BA** is designed for single phase full wave rectification, which has four fast recovery diodes connected in a single phase bridge configuration. **FDF60BA** is suitable for high frequency application requiring low loss and high speed control.

- High Speed $t_{rr} \leq 100\text{ns}$
- Output Current, DC60A
- Isolated Mounting base.

(Applications)

Switching Power Supply, Inverter Welding Power Supply
Power Supply for Telecommunication

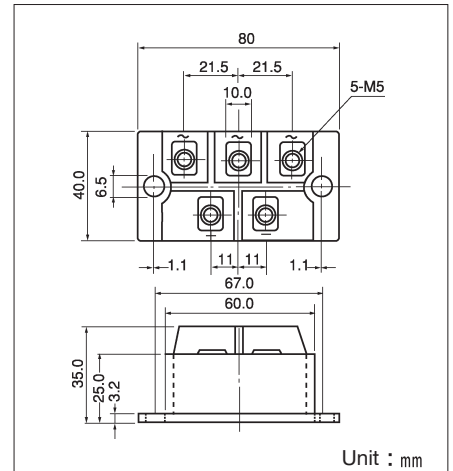
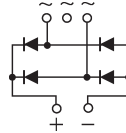

Maximum Ratings

($T_j = 25^\circ\text{C}$)

Symbol	Item	Ratings		Unit
		FDF60BA50	FDF60BA60	
V_{RRM}	Repetitive Peak Reverse Voltage	500	600	V
$V_{R(DC)}$	D.C. Reverse Voltage	400	480	V

Symbol	Item	Conditions	Ratings	Unit	
I_D	Output current	D.C. $T_c : 80^\circ\text{C}$	60	A	
I_{FSM}	Surge Forward Current	$1/2$ cycle, 60Hz, peak value, non-repetitive	600	A	
I^2t	I^2t	Value for one cycle of surge current	1490	A^2S	
T_j	Operating Junction Temperature		$-40 \sim +150$	$^\circ\text{C}$	
T_{stg}	Storage Temperature		$-40 \sim +125$	$^\circ\text{C}$	
V_{ISO}	Isolation Breakdown Voltage (R.M.S.)	A.C. 1 minute	2500	V	
	Mounting Torque	Mounting (M6)	Recommended Value 2.5~3.9 (25~40)	4.7 (48)	$\text{N} \cdot \text{m}$ ($\text{kgf} \cdot \text{cm}$)
		Terminal (M5)	Recommended Value 1.5~2.5 (15~25)	2.7 (28)	
	Mass	Typical Value	200	g	

Electrical Characteristics

Symbol	Item	Conditions	Ratings		Unit
			Typ.	Max.	
I_{RRM}	Repetitive Peak Reverse Current	$V_R = V_{RRM}$, $T_j = 125^\circ\text{C}$		60	mA
V_{FM}	Forward Voltage Drop	$I_{FM} = 60\text{A}$, Inst. measurement	1.40	1.60	V
t_{rr}	Reverse Recovery Time	$I_F = 60\text{A}$, $-di/dt = 100\text{A}/\mu\text{s}$	85	100	ns
$R_{th(j-c)}$	Thermal Impedance	Junction to case (a module)		0.36	$^\circ\text{C}/\text{W}$

Forward Characteristics

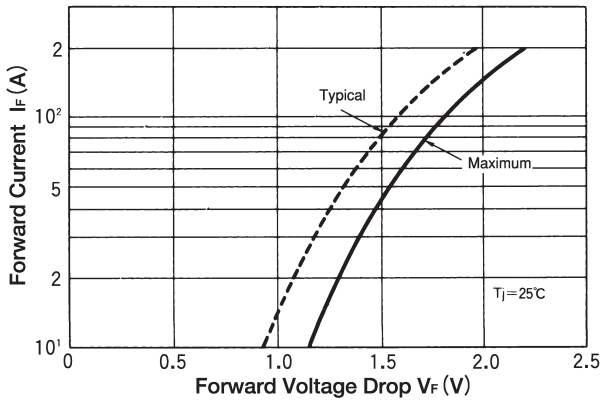

Cycle Surge Forward Current Rating (Non-Repetitive)

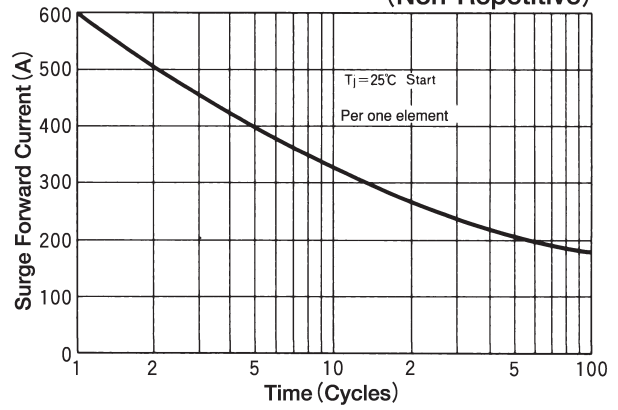

Transient Thermal Impedance

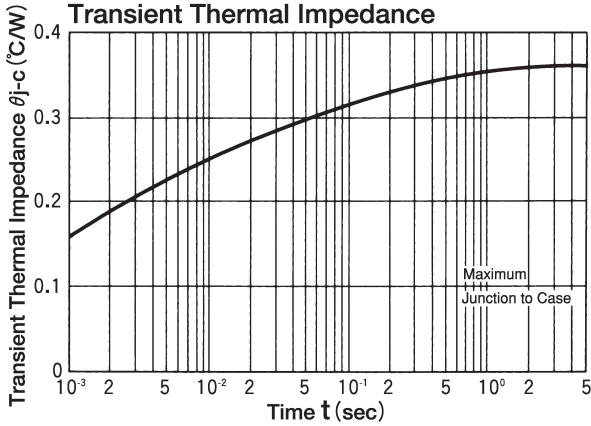

Reverse Recovery Characteristics

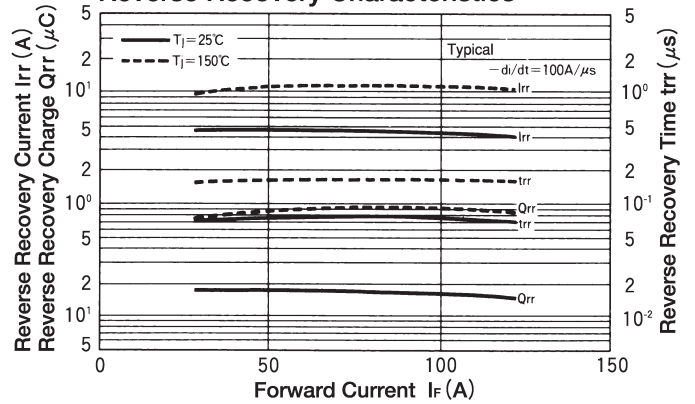

Reverse Characteristics

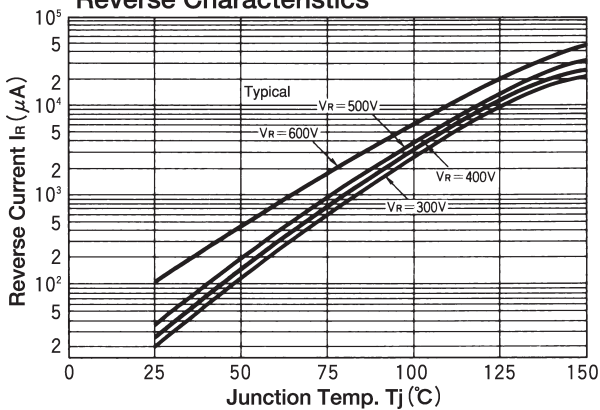

Reverse Recovery Characteristics

