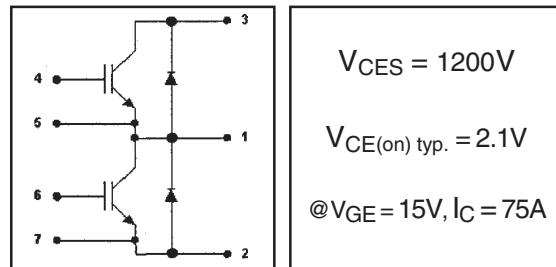


**Features**

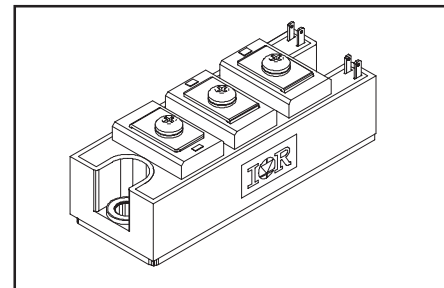
- Generation 4 IGBT technology
- UltraFast: Optimized for high operating frequencies 8-40 kHz in hard switching, >200 kHz in resonant mode
- Very low conduction and switching losses
- HEXFRED™ antiparallel diodes with ultra- soft recovery
- Industry standard package
- UL approved

**Benefits**

- Increased operating efficiency
- Direct mounting to heatsink
- Performance optimized for power conversion: UPS, SMPS, Welding
- Lower EMI, requires less snubbing



$V_{CES} = 1200V$   
 $V_{CE(on) typ.} = 2.1V$   
@  $V_{GE} = 15V, I_C = 75A$



**Absolute Maximum Ratings**

	Parameter	Max.	Units
$V_{CES}$	Collector-to-Emitter Voltage	1200	V
$I_C @ T_C = 25^\circ C$	Continuous Collector Current	75	A
$I_{CM}$	Pulsed Collector Current ①	150	
$I_{LM}$	Peak Switching Current ②	150	
$I_{FM}$	Peak Diode Forward Current	150	
$V_{GE}$	Gate-to-Emitter Voltage	$\pm 20$	
$V_{ISOL}$	RMS Isolation Voltage, Any Terminal To Case, t = 1 min	2500	W
$P_D @ T_C = 25^\circ C$	Maximum Power Dissipation	390	
$P_D @ T_C = 85^\circ C$	Maximum Power Dissipation	200	
$T_J$	Operating Junction Temperature Range	-40 to +150	°C
$T_{STG}$	Storage Temperature Range	-40 to +125	

**Thermal / Mechanical Characteristics**

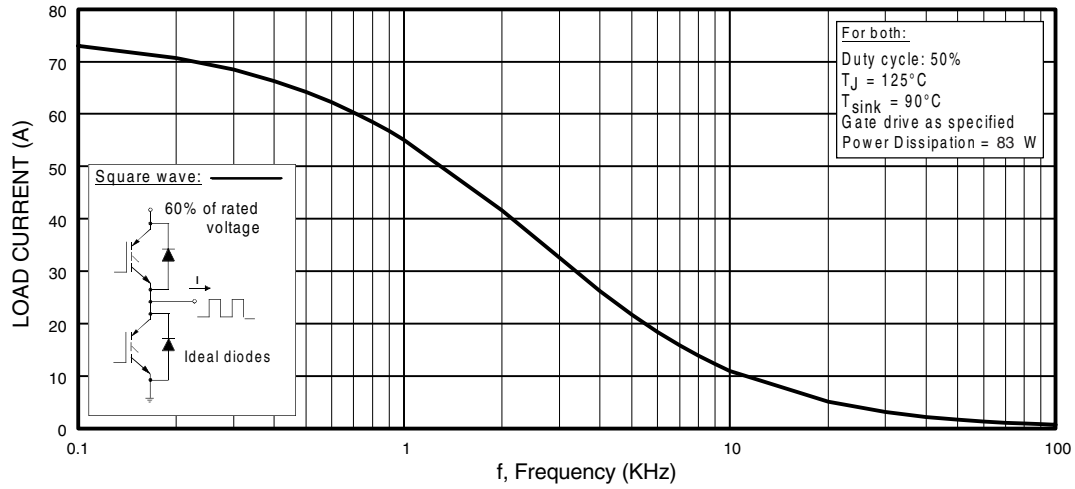
	Parameter	Typ.	Max.	Units
$R_{\theta JC}$	Thermal Resistance, Junction-to-Case - IGBT	—	0.32	°C/W
$R_{\theta JC}$	Thermal Resistance, Junction-to-Case - Diode	—	0.35	
$R_{\theta CS}$	Thermal Resistance, Case-to-Sink - Module	0.1	—	N·m
	Mounting Torque, Case-to-Heatsink	—	4.0	
	Mounting Torque, Case-to-Terminal 1, 2 & 3 ③	—	3.0	
	Weight of Module	200	—	g

## Electrical Characteristics @ $T_J = 25^\circ\text{C}$ (unless otherwise specified)

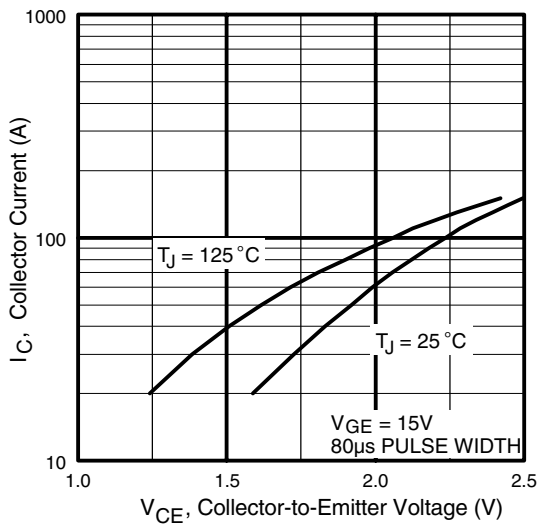
	Parameter	Min.	Typ.	Max.	Units	Conditions
$V_{(BR)CES}$	Collector-to-Emitter Breakdown Voltage	1200	—	—	V	$V_{GE} = 0V, I_C = 1mA$
$V_{CE(on)}$	Collector-to-Emitter Voltage	—	2.1	3.1		$V_{GE} = 15V, I_C = 75A$
		—	1.9	—		$V_{GE} = 15V, I_C = 75A, T_J = 125^\circ\text{C}$
$V_{GE(th)}$	Gate Threshold Voltage	3.0	—	6.0		$V_{CE} = 6.0V, I_C = 750\mu A$
$\Delta V_{GE(th)}/\Delta T_J$	Temperature Coeff. of Threshold Voltage	—	-11	—	mV/ $^\circ\text{C}$	$V_{CE} = 6.0V, I_C = 750\mu A$
$g_{fe}$	Forward Transconductance ④	—	107	—	S	$V_{CE} = 25V, I_C = 75A$
$I_{CES}$	Collector-to-Emitter Leaking Current	—	—	1.0	mA	$V_{GE} = 0V, V_{CE} = 1200V$
		—	—	10		$V_{GE} = 0V, V_{CE} = 1200V, T_J = 125^\circ\text{C}$
$V_{FM}$	Diode Forward Voltage - Maximum	—	2.3	3.3	V	$I_F = 75A, V_{GE} = 0V$
		—	2.1	—		$I_F = 75A, V_{GE} = 0V, T_J = 125^\circ\text{C}$
$I_{GES}$	Gate-to-Emitter Leakage Current	—	—	250	nA	$V_{GE} = \pm 20V$

## Dynamic Characteristics - $T_J = 125^\circ\text{C}$ (unless otherwise specified)

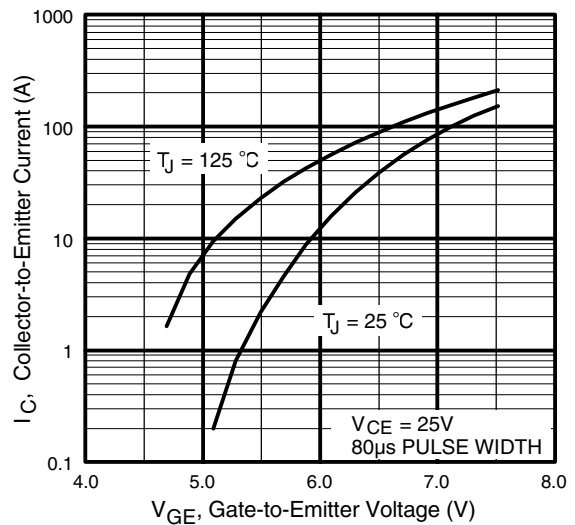
	Parameter	Min.	Typ.	Max.	Units	Conditions
$Q_g$	Total Gate Charge (turn-on)	—	570	854	nC	$V_{CC} = 400V$
$Q_{ge}$	Gate - Emitter Charge (turn-on)	—	96	144		$I_C = 85A$
$Q_{gc}$	Gate - Collector Charge (turn-on)	—	189	283		$T_J = 25^\circ\text{C}$
$t_{d(on)}$	Turn-On Delay Time	—	109	—	ns	$R_{G1} = 15\Omega, R_{G2} = 0\Omega,$
$t_r$	Rise Time	—	119	—		$I_C = 75A$
$t_{d(off)}$	Turn-Off Delay Time	—	392	—		$V_{CC} = 720V$
$t_f$	Fall Time	—	402	—		$V_{GE} = \pm 15V$
$E_{on}$	Turn-On Switching Energy	—	11	—	mJ	Inductor load
$E_{off(1)}$	Turn-Off Switching Energy	—	20	—		
$E_{ts(1)}$	Total Switching Energy	—	31	45		
$C_{ies}$	Input Capacitance	—	12815	—	pF	$V_{GE} = 0V$
$C_{oes}$	Output Capacitance	—	570	—		$V_{CC} = 30V$
$C_{res}$	Reverse Transfer Capacitance	—	110	—		$f = 1\text{ MHz}$
$t_{rr}$	Diode Reverse Recovery Time	—	174	—	ns	$I_C = 75A$
$I_{rr}$	Diode Peak Reverse Current	—	107	—		$R_{G1} = 15\Omega$
$Q_{rr}$	Diode Recovery Charge	—	9367	—		$R_{G2} = 0\Omega$
$di_{(rec)}/dt$	Diode Peak Rate of Fall of Recovery During $t_b$	—	1491	—		$V_{CC} = 720V$ $di/dt = 1300A/\mu s$



**Fig. 1** - Typical Load Current vs. Frequency  
 (Load Current =  $I_{\text{RMS}}$  of fundamental)

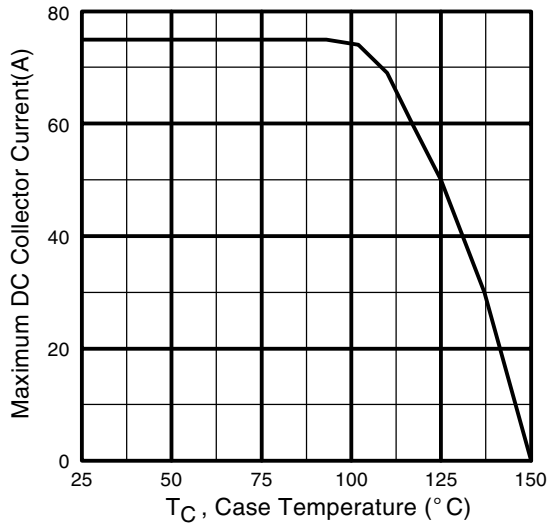


**Fig. 2** - Typical Output Characteristics

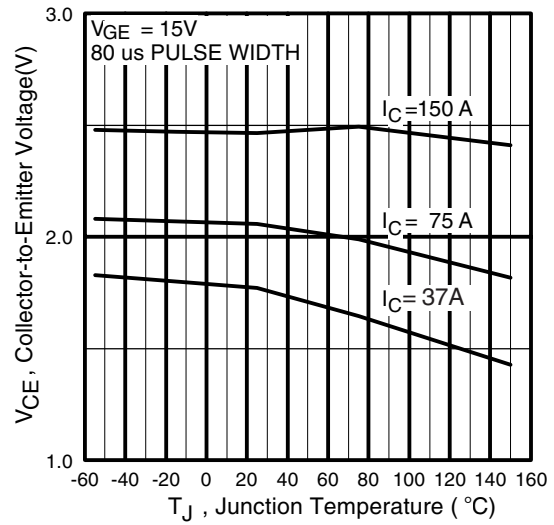


**Fig. 3** - Typical Transfer Characteristics

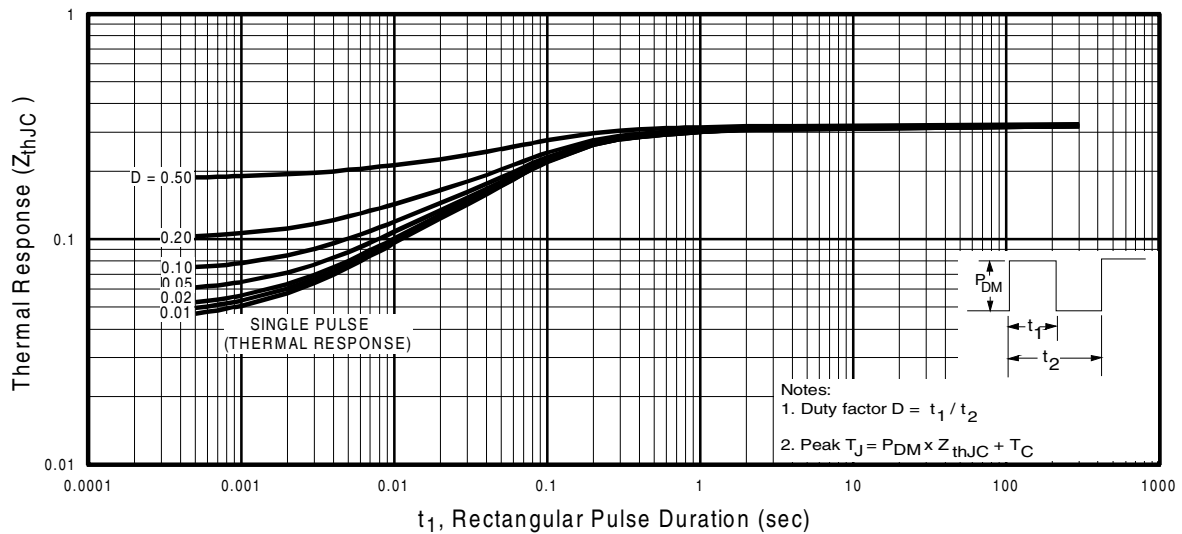
# GA75TS120U



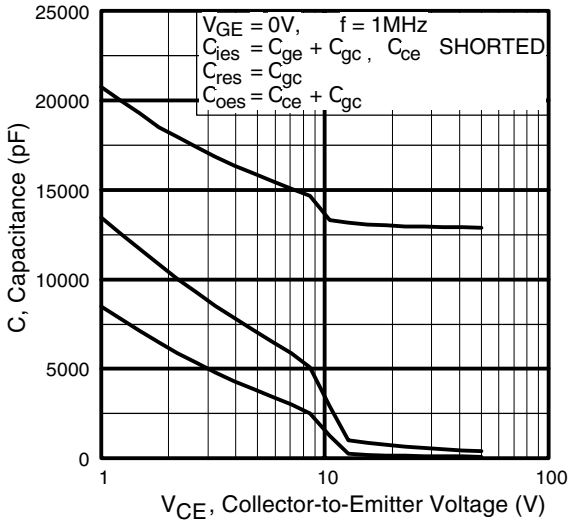
**Fig. 4** - Maximum Collector Current vs. Case Temperature



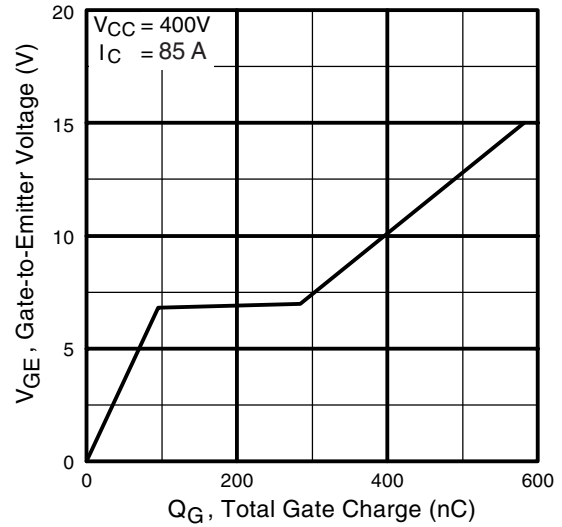
**Fig. 5** - Typical Collector-to-Emitter Voltage vs. Junction Temperature



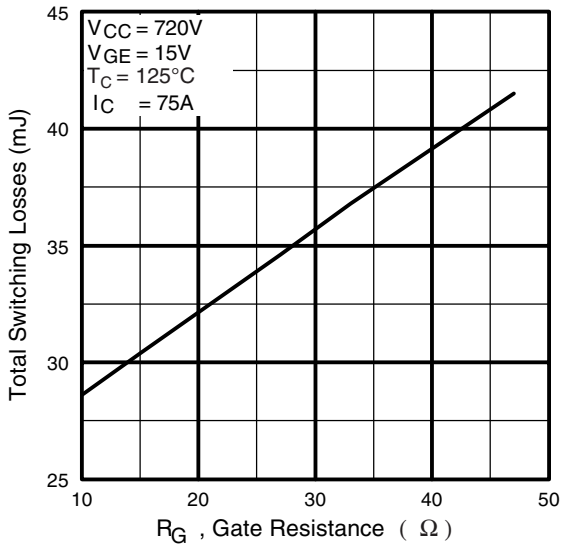
**Fig. 6** - Maximum Effective Transient Thermal Impedance, Junction-to-Case



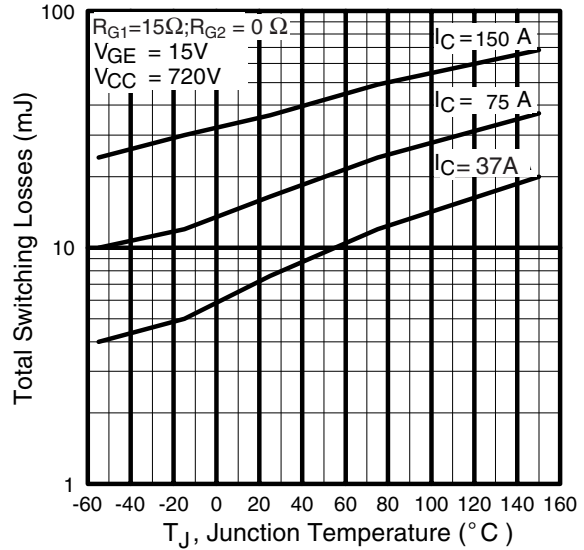
**Fig. 7** - Typical Capacitance vs. Collector-to-Emitter Voltage



**Fig. 8** - Typical Gate Charge vs. Gate-to-Emitter Voltage

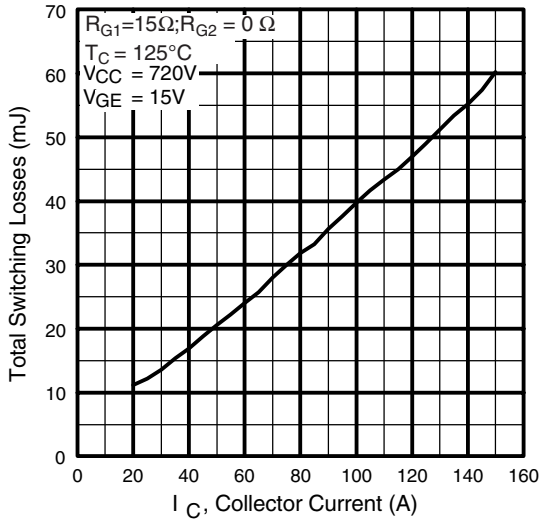


**Fig. 9** - Typical Switching Losses vs. Gate Resistance

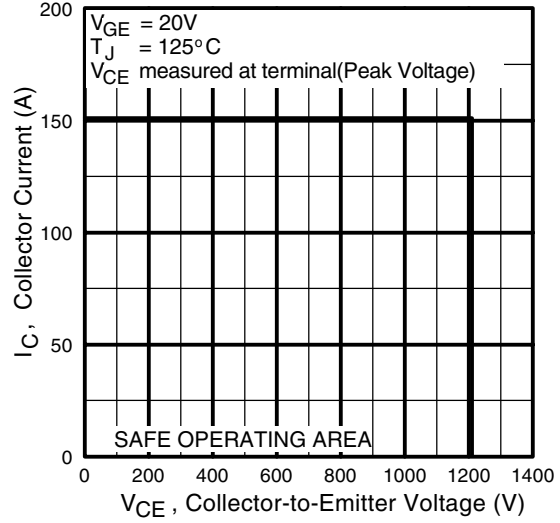


**Fig. 10** - Typical Switching Losses vs. Junction Temperature

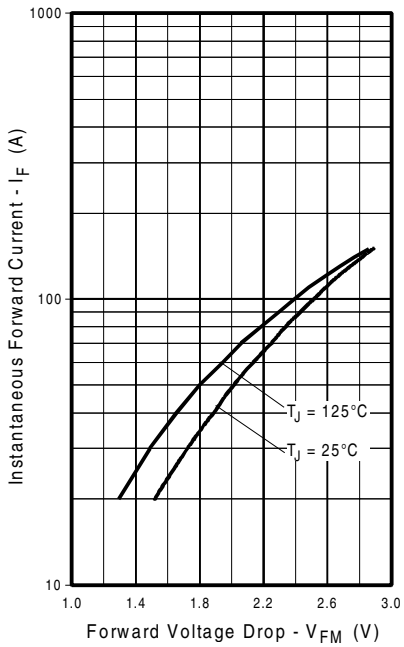
# GA75TS120U



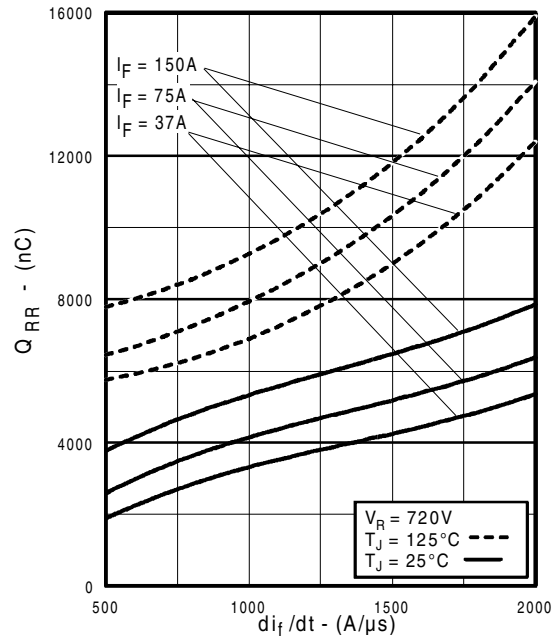
**Fig. 11** - Typical Switching Losses vs. Collector-to-Emitter Current



**Fig. 12** - Reverse Bias SOA



**Fig. 13** - Typical Forward Voltage Drop vs. Instantaneous Forward Current



**Fig. 14** - Typical Stored Charge vs.  $di/dt$

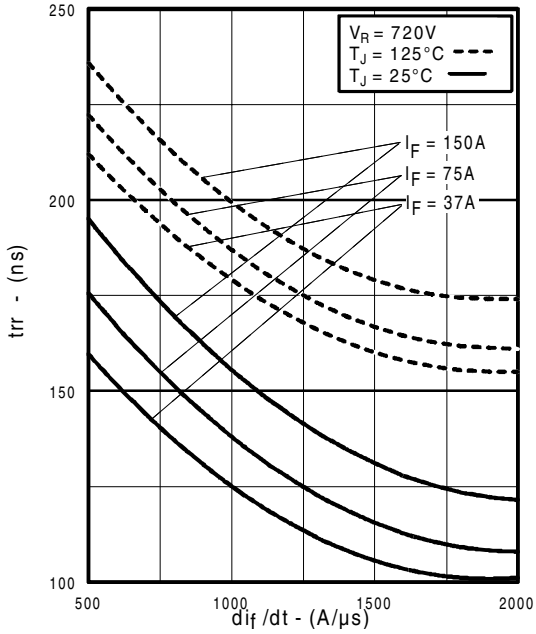


Fig. 15 - Typical Reverse Recovery vs.  $dI_f/dt$

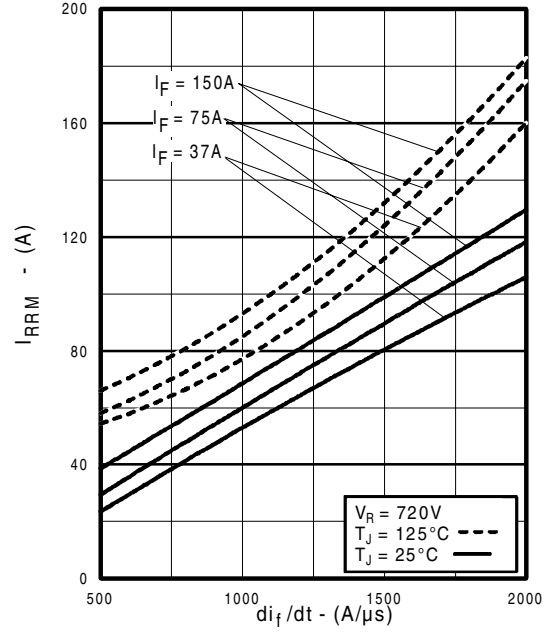
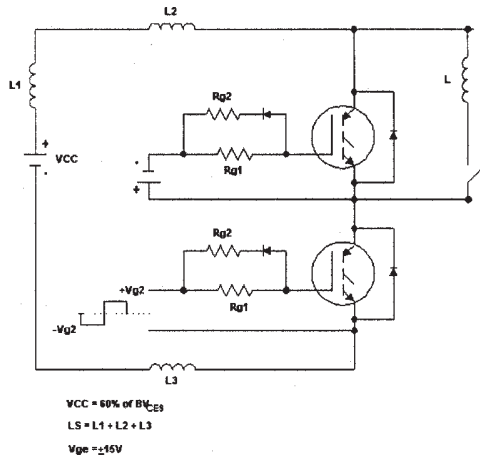
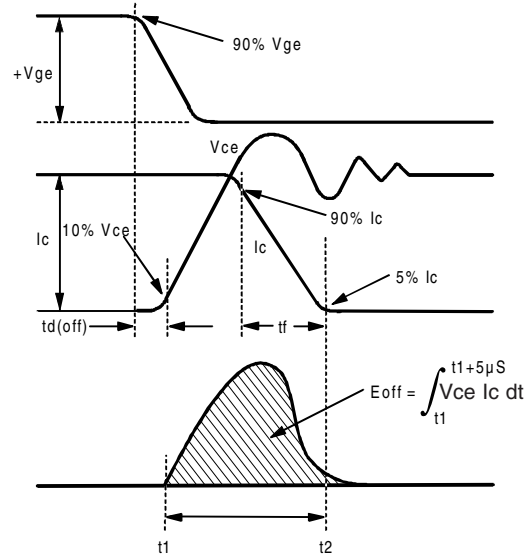


Fig. 16 - Typical Recovery Current vs.  $dI_f/dt$

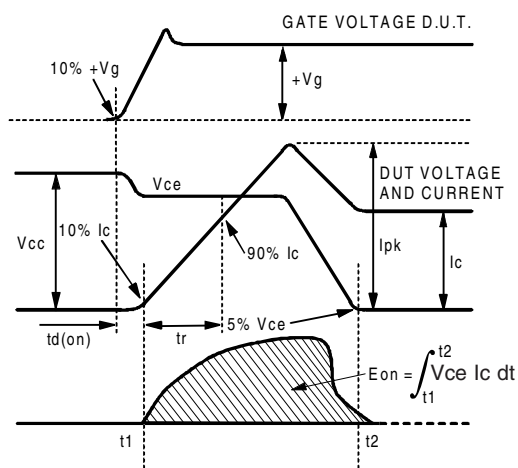
# GA75TS120U



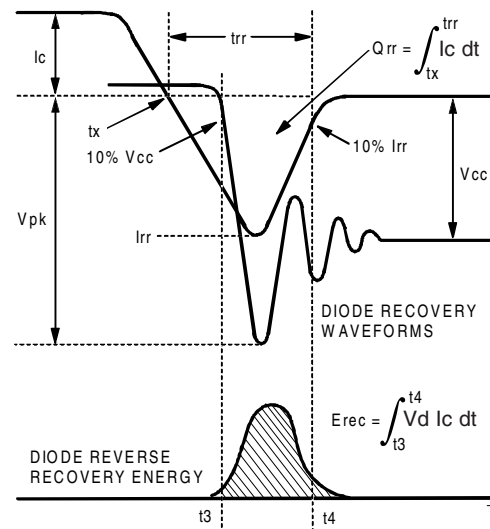
**Fig. 17a** - Test Circuit for Measurement of  $I_{LM}$ ,  $E_{on}$ ,  $E_{off}(\text{diode})$ ,  $t_{rr}$ ,  $Q_{rr}$ ,  $I_{rr}$ ,  $t_{d(on)}$ ,  $t_r$ ,  $t_{d(off)}$ ,  $t_f$



**Fig. 17b** - Test Waveforms for Circuit of Fig. 18a, Defining  $E_{off}$ ,  $t_{d(off)}$ ,  $t_f$



**Fig. 17c** - Test Waveforms for Circuit of Fig. 18a, Defining  $E_{on}$ ,  $t_{d(on)}$ ,  $t_r$



**Fig. 17d** - Test Waveforms for Circuit of Fig. 18a, Defining  $E_{rec}$ ,  $t_{rr}$ ,  $Q_{rr}$ ,  $I_{rr}$



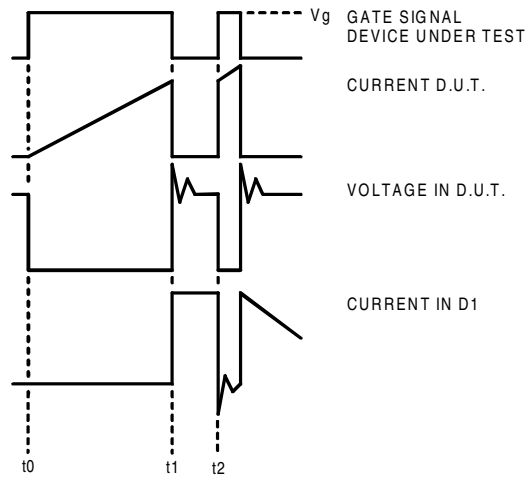


Figure 17e. Macro Waveforms for Figure 18a's Test Circuit

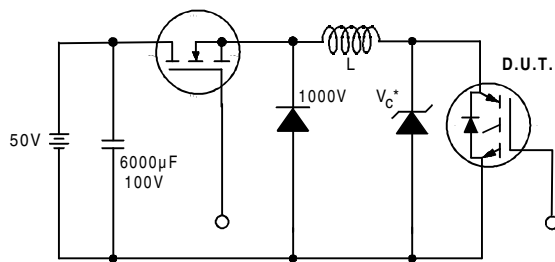


Figure 18. Clamped Inductive Load Test Circuit

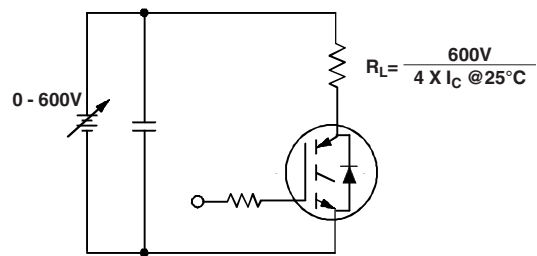


Figure 19. Pulsed Collector Current Test Circuit

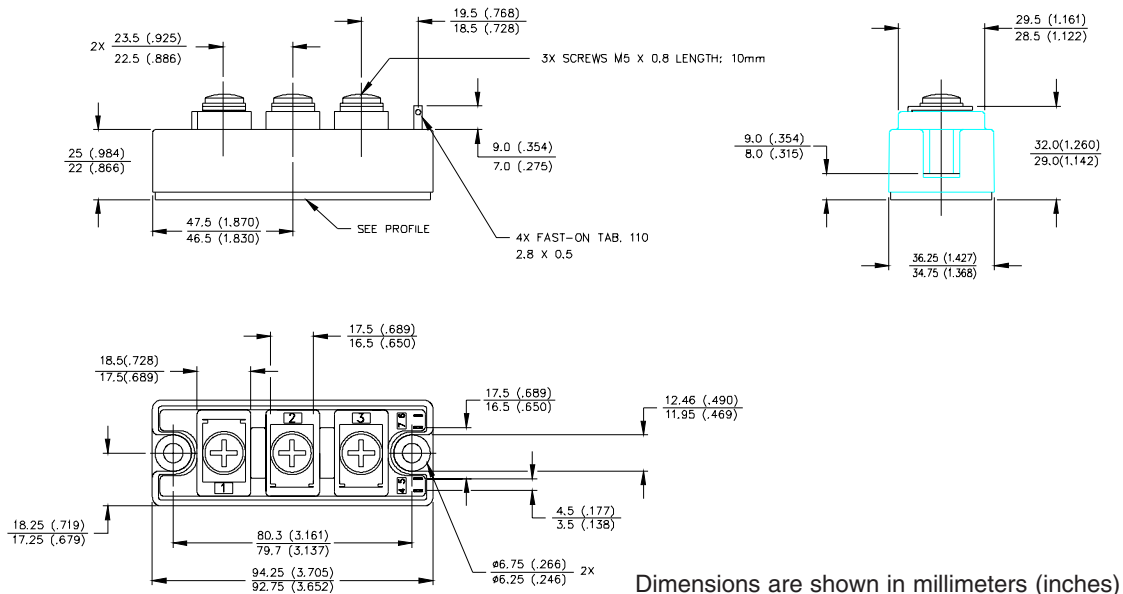
# GA75TS120U

International  
**IR** Rectifier

## Notes:

- ① Repetitive rating;  $V_{GE} = 20V$ , pulse width limited by max. junction temperature.
- ② See fig. 17
- ③ For screws M5x0.8
- ④ Pulse width 50 $\mu$ s; single shot.

## Case Outline — INT-A-PAK



International  
**IR** Rectifier

**IR WORLD HEADQUARTERS:** 233 Kansas St., El Segundo, California 90245, USA Tel: (310) 252-7105  
**IR EUROPEAN REGIONAL CENTRE:** 439/445 Godstone Rd, Whyteleafe, Surrey CR3 OBL, UK Tel: ++ 44 (0)20 8645 8000  
**IR CANADA:** 15 Lincoln Court, Brampton, Ontario L6T3Z2, Tel: (905) 453 2200  
**IR GERMANY:** Saalburgstrasse 157, 61350 Bad Homburg Tel: ++ 49 (0) 6172 96590  
**IR ITALY:** Via Liguria 49, 10071 Borgaro, Torino Tel: ++ 39 011 451 0111  
**IR JAPAN:** K&H Bldg., 2F, 30-4 Nishi-Ikebukuro 3-Chome, Toshima-Ku, Tokyo 171 Tel: 81 (0)3 3983 0086  
**IR SOUTHEAST ASIA:** 1 Kim Seng Promenade, Great World City West Tower, 13-11, Singapore 237994 Tel: ++ 65 (0)838 4630  
**IR TAIWAN:** 16 Fl. Suite D. 207, Sec. 2, Tun Haw South Road, Taipei, 10673 Tel: 886-(0)2 2377 9936  
*Data and specifications subject to change without notice. 4/00*