

IRF540PbF

HEXFET® Power MOSFET

- Dynamic dv/dt Rating
- Repetitive Avalanche Rated
- 175°C Operating Temperature
- Fast Switching
- Ease of Paralleling
- Simple Drive Requirements
- Lead-Free

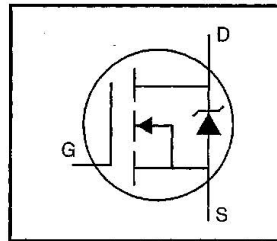

$$V_{DSS} = 100V$$

$$R_{DS(on)} = 0.077\Omega$$

$$I_D = 28A$$

Description

Third Generation HEXFETs from International Rectifier provide the designer with the best combination of fast switching, ruggedized device design, low on-resistance and cost-effectiveness.

The TO-220 package is universally preferred for all commercial-industrial applications at power dissipation levels to approximately 50 watts. The low thermal resistance and low package cost of the TO-220 contribute to its wide acceptance throughout the industry.

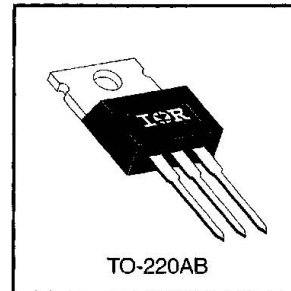

Absolute Maximum Ratings

	Parameter	Max.	Units
I_D @ $T_C = 25^\circ C$	Continuous Drain Current, V_{GS} @ 10 V	28	A
I_D @ $T_C = 100^\circ C$	Continuous Drain Current, V_{GS} @ 10 V	20	
I_{DM}	Pulsed Drain Current ①	110	
P_D @ $T_C = 25^\circ C$	Power Dissipation	150	W
	Linear Derating Factor	1.0	W/°C
V_{GS}	Gate-to-Source Voltage	±20	V
E_{AS}	Single Pulse Avalanche Energy ②	230	mJ
I_{AR}	Avalanche Current ①	28	A
E_{AR}	Repetitive Avalanche Energy ①	15	mJ
dv/dt	Peak Diode Recovery dv/dt ③	5.5	V/ns
T_J T_{STG}	Operating Junction and Storage Temperature Range	-55 to +175	°C
	Soldering Temperature, for 10 seconds	300 (1.6mm from case)	
	Mounting Torque, 6-32 or M3 screw	10 lbf•in (1.1 N•m)	

Thermal Resistance

	Parameter	Min.	Typ.	Max.	Units
$R_{\theta JC}$	Junction-to-Case	—	—	1.0	°C/W
$R_{\theta CS}$	Case-to-Sink, Flat, Greased Surface	—	0.50	—	
$R_{\theta JA}$	Junction-to-Ambient	—	—	62	

Electrical Characteristics @ $T_J = 25^\circ\text{C}$ (unless otherwise specified)

	Parameter	Min.	Typ.	Max.	Units	Test Conditions
$V_{(BR)DSS}$	Drain-to-Source Breakdown Voltage	100	—	—	V	$V_{GS}=0V, I_D=250\mu A$
$\Delta V_{(BR)DSS}/\Delta T_J$	Breakdown Voltage Temp. Coefficient	—	0.13	—	V/°C	Reference to $25^\circ\text{C}, I_D=1\text{mA}$
$R_{DS(on)}$	Static Drain-to-Source On-Resistance	—	—	0.077	Ω	$V_{GS}=10V, I_D=17A$ ④
$V_{GS(th)}$	Gate Threshold Voltage	2.0	—	4.0	V	$V_{DS}=V_{GS}, I_D=250\mu A$
g_{fs}	Forward Transconductance	8.7	—	—	S	$V_{DS}=50V, I_D=17A$ ④
I_{DSS}	Drain-to-Source Leakage Current	—	—	25	μA	$V_{DS}=100V, V_{GS}=0V$
		—	—	250		$V_{DS}=80V, V_{GS}=0V, T_J=150^\circ\text{C}$
I_{GSS}	Gate-to-Source Forward Leakage	—	—	100	nA	$V_{GS}=20V$
	Gate-to-Source Reverse Leakage	—	—	-100		$V_{GS}=-20V$
Q_g	Total Gate Charge	—	—	72	nC	$I_D=17A$ $V_{DS}=80V$ $V_{GS}=10V$ See Fig. 6 and 13 ④
Q_{gs}	Gate-to-Source Charge	—	—	11		
Q_{gd}	Gate-to-Drain ("Miller") Charge	—	—	32		
$t_{d(on)}$	Turn-On Delay Time	—	11	—		
t_r	Rise Time	—	44	—	ns	$V_{DD}=50V$ $I_D=17A$ $R_G=9.1\Omega$ $R_D=2.9\Omega$ See Figure 10 ④
$t_{d(off)}$	Turn-Off Delay Time	—	53	—		
t_f	Fall Time	—	43	—		
L_D	Internal Drain Inductance	—	4.5	—	nH	Between lead, 6 mm (0.25in.) from package and center of die contact 
L_S	Internal Source Inductance	—	7.5	—		
C_{iss}	Input Capacitance	—	1700	—	pF	$V_{GS}=0V$ $V_{DS}=25V$ $f=1.0\text{MHz}$ See Figure 5
C_{oss}	Output Capacitance	—	560	—		
C_{rss}	Reverse Transfer Capacitance	—	120	—		

Source-Drain Ratings and Characteristics

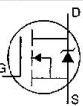
	Parameter	Min.	Typ.	Max.	Units	Test Conditions
I_S	Continuous Source Current (Body Diode)	—	—	28	A	MOSFET symbol showing the integral reverse p-n junction diode. 
I_{SM}	Pulsed Source Current (Body Diode) ①	—	—	110		
V_{SD}	Diode Forward Voltage	—	—	2.5	V	$T_J=25^\circ\text{C}, I_S=28A, V_{GS}=0V$ ④
t_{rr}	Reverse Recovery Time	—	180	360	ns	$T_J=25^\circ\text{C}, I_F=17A$
Q_{rr}	Reverse Recovery Charge	—	1.3	2.8	μC	$di/dt=100A/\mu s$ ④
t_{on}	Forward Turn-On Time	Intrinsic turn-on time is negligible (turn-on is dominated by L_S+L_D)				

Notes:

- ① Repetitive rating; pulse width limited by max. junction temperature (See Figure 11)
- ② $V_{DD}=25V$, starting $T_J=25^\circ\text{C}$, $L=440\mu H$, $R_G=25\Omega$, $I_{AS}=28A$ (See Figure 12)
- ③ $I_{SD}\leq 28A$, $di/dt\leq 170A/\mu s$, $V_{DD}\leq V_{(BR)DSS}$, $T_J\leq 175^\circ\text{C}$
- ④ Pulse width $\leq 300\mu s$; duty cycle $\leq 2\%$.

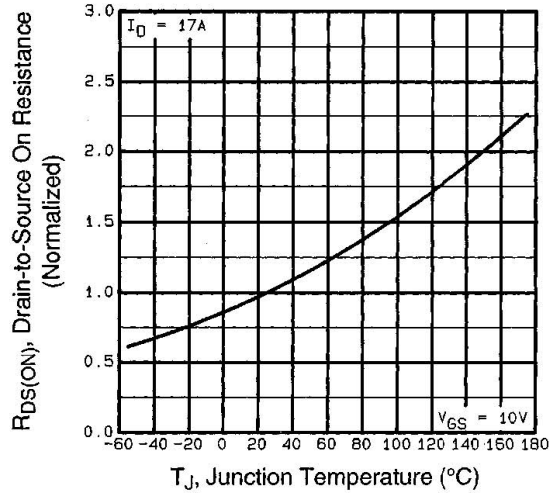
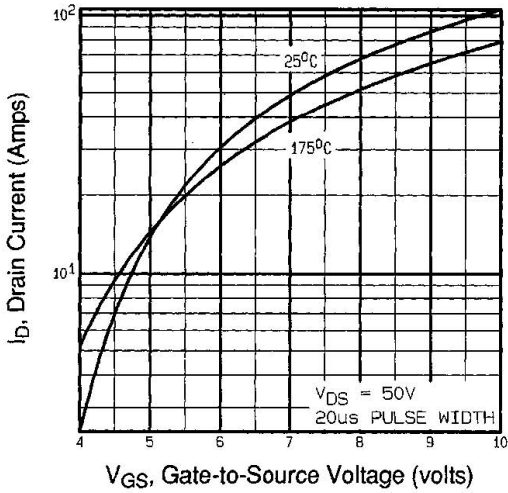
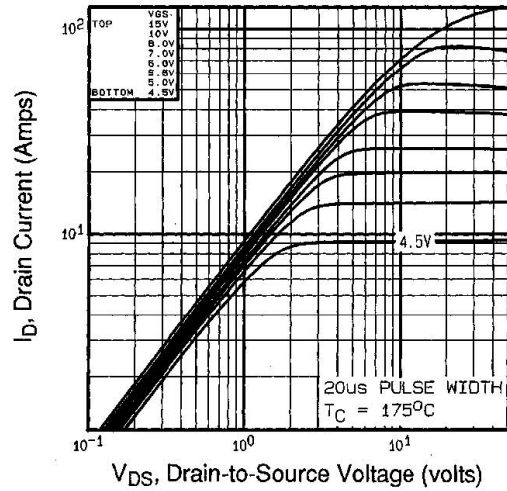
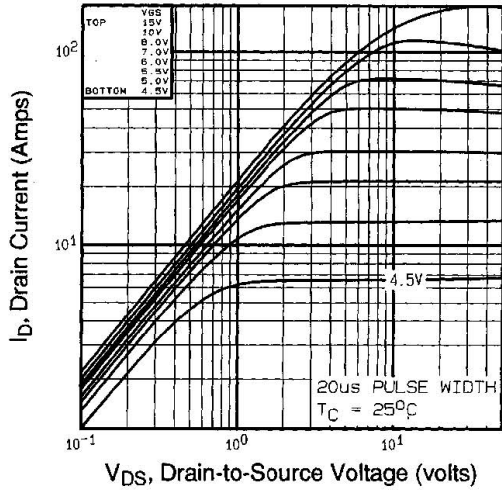

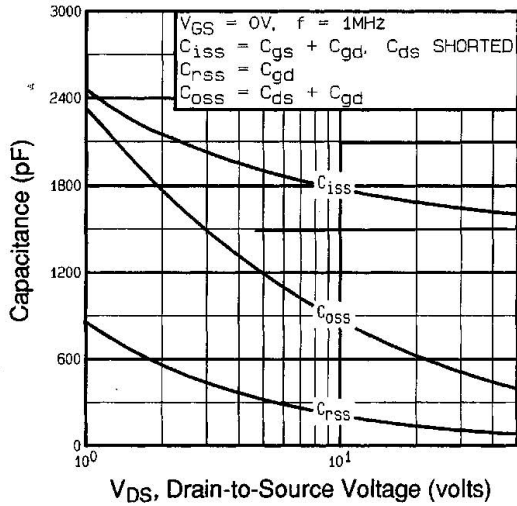

Fig 5. Typical Capacitance Vs. Drain-to-Source Voltage

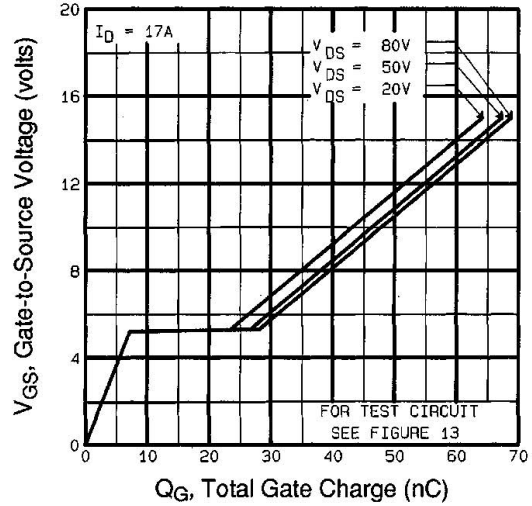

Fig 6. Typical Gate Charge Vs. Gate-to-Source Voltage

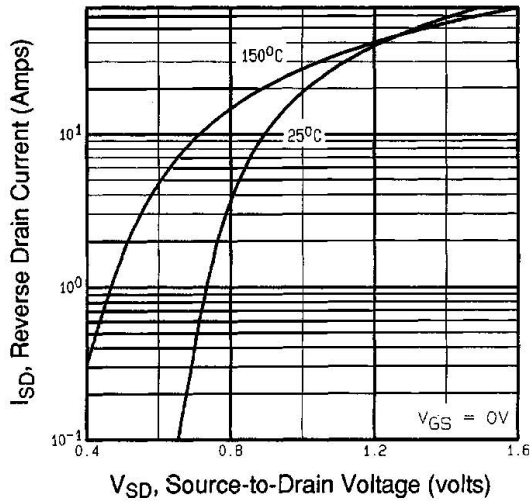

Fig 7. Typical Source-Drain Diode Forward Voltage

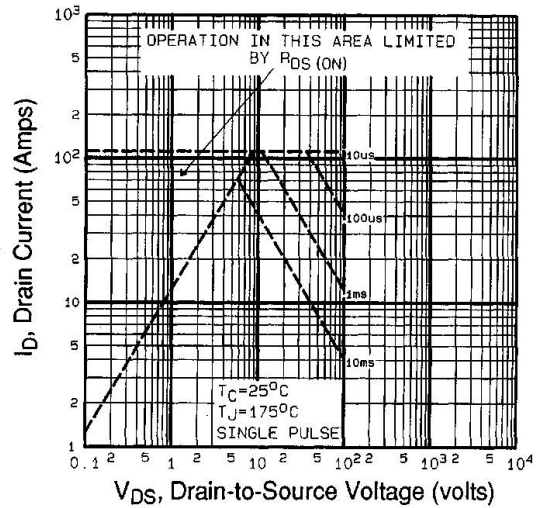

Fig 8. Maximum Safe Operating Area

IRF540PbF

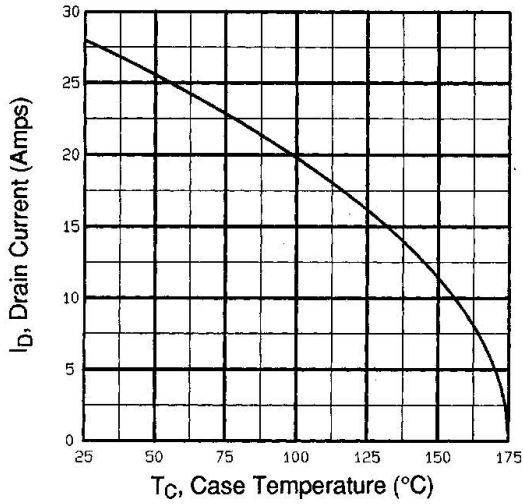

Fig 9. Maximum Drain Current Vs. Case Temperature

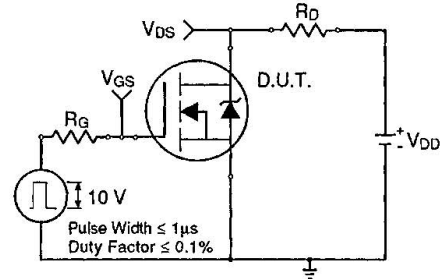

Fig 10a. Switching Time Test Circuit

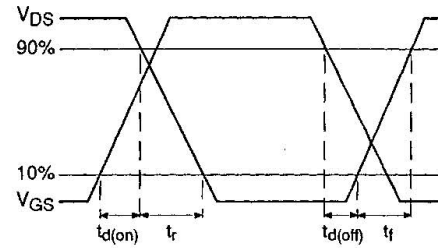

Fig 10b. Switching Time Waveforms

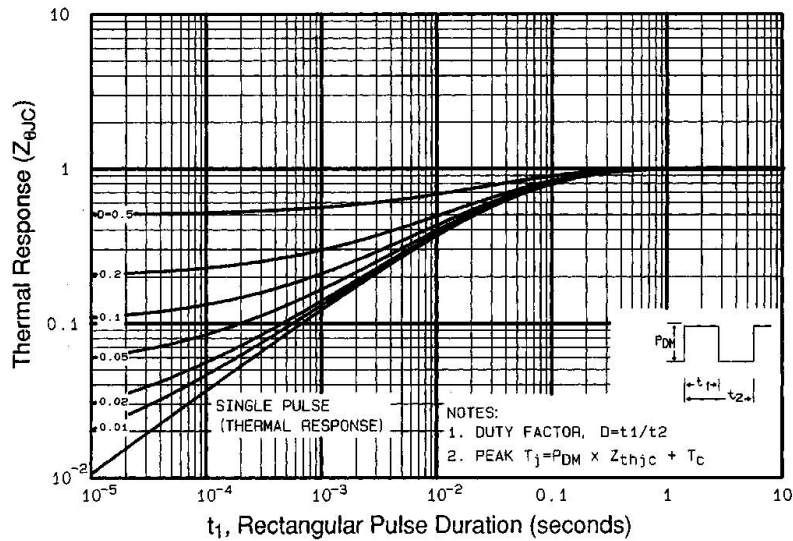

Fig 11. Maximum Effective Transient Thermal Impedance, Junction-to-Case

IRF540PbF

International
IR Rectifier

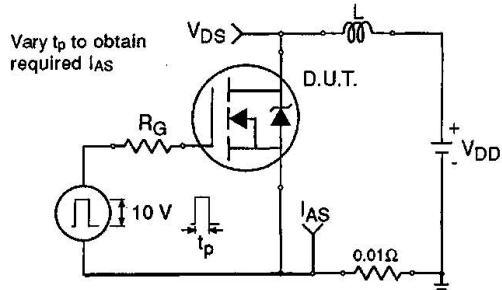

Fig 12a. Unclamped Inductive Test Circuit

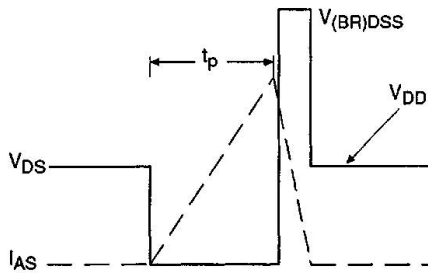

Fig 12b. Unclamped Inductive Waveforms

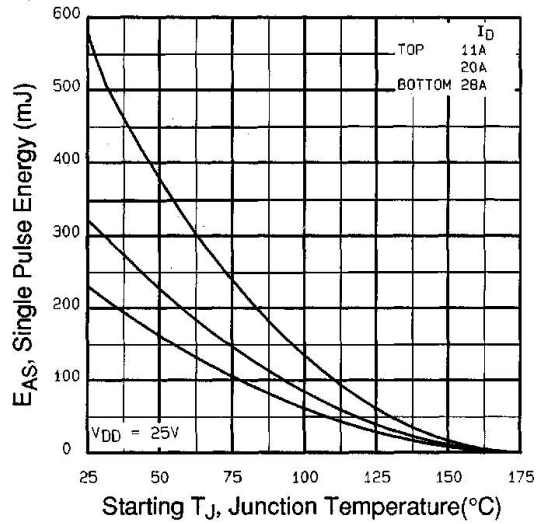

Fig 12c. Maximum Avalanche Energy Vs. Drain Current

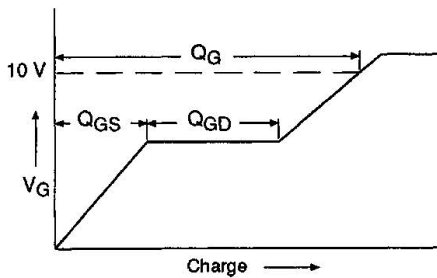

Fig 13a. Basic Gate Charge Waveform

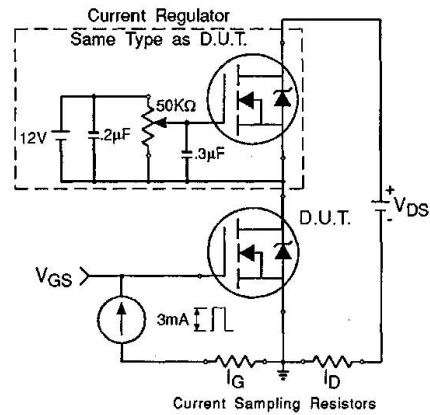

Fig 13b. Gate Charge Test Circuit

Appendix A: Figure 14, Peak Diode Recovery dv/dt Test Circuit – See page 1505

Appendix B: Package Outline Mechanical Drawing – See page 1509

Appendix E: Optional Leadforms – See page 1525

TO-220AB Package Outline

Dimensions are shown in millimeters (inches)

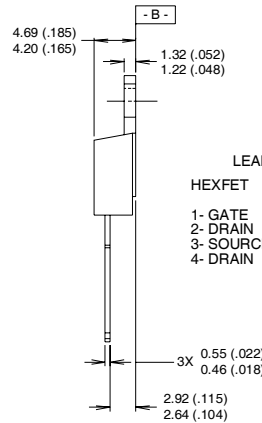
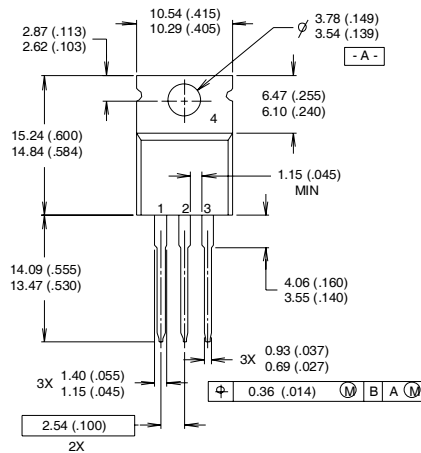

LEAD ASSIGNMENTS

HEXFET	IGBTs, CoPACK
1- GATE	1- GATE
2- DRAIN	2- COLLECTOR
3- SOURCE	3- EMITTER
4- DRAIN	4- COLLECTOR

NOTES:

- 1 DIMENSIONING & TOLERANCING PER ANSI Y14.5M, 1982.
- 2 CONTROLLING DIMENSION : INCH

- 3 OUTLINE CONFORMS TO JEDEC OUTLINE TO-220AB.
- 4 HEATSINK & LEAD MEASUREMENTS DO NOT INCLUDE BURRS.

TO-220AB Part Marking Information

EXAMPLE: THIS IS AN IRF1010
 LOT CODE 1789
 ASSEMBLED ON WW 19, 1997
 IN THE ASSEMBLY LINE "C"
Note: "P" in assembly line
 position indicates "Lead-Free"

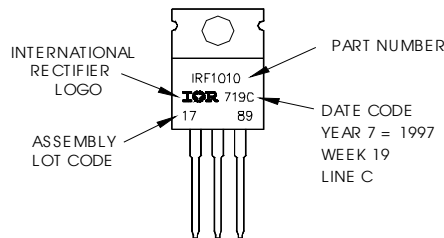

Data and specifications subject to change without notice.