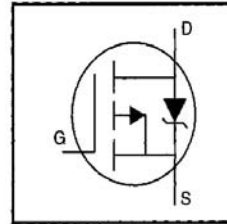
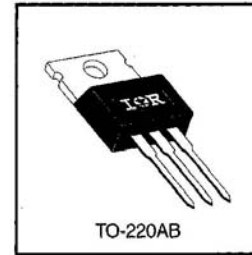


# IRF9520PbF

- Dynamic dv/dt Rating
- Repetitive Avalanche Rated
- P-Channel
- 175°C Operating Temperature
- Fast Switching
- Ease of Paralleling
- Simple Drive Requirements
  - Lead-Free



$V_{DSS} = -100V$
$R_{DS(on)} = 0.60\Omega$
$I_D = -6.8A$



### Description

Third Generation HEXFETs from International Rectifier provide the designer with the best combination of fast switching, ruggedized device design, low on-resistance and cost-effectiveness.

The TO-220 package is universally preferred for all commercial-industrial applications at power dissipation levels to approximately 50 watts. The low thermal resistance and low package cost of the TO-220 contribute to its wide acceptance throughout the industry.

### Absolute Maximum Ratings

	Parameter	Max.	Units
$I_D @ T_C = 25^\circ C$	Continuous Drain Current, $V_{GS} @ -10 V$	-6.8	A
$I_D @ T_C = 100^\circ C$	Continuous Drain Current, $V_{GS} @ -10 V$	-4.8	
$I_{DM}$	Pulsed Drain Current ①	-27	
$P_D @ T_C = 25^\circ C$	Power Dissipation	60	W
	Linear Derating Factor	0.40	W/°C
$V_{GS}$	Gate-to-Source Voltage	$\pm 20$	V
$E_{AS}$	Single Pulse Avalanche Energy ②	300	mJ
$I_{AR}$	Avalanche Current ①	-6.8	A
$E_{AR}$	Repetitive Avalanche Energy ①	6.0	mJ
dv/dt	Peak Diode Recovery dv/dt ③	-5.5	V/ns
$T_J$ $T_{STG}$	Operating Junction and Storage Temperature Range	-55 to +175	°C
	Soldering Temperature, for 10 seconds	300 (1.6mm from case)	
	Mounting Torque, 6-32 or M3 screw	10 lbf·in (1.1 N·m)	

### Thermal Resistance

	Parameter	Min.	Typ.	Max.	Units
$R_{\theta JC}$	Junction-to-Case	—	—	2.5	°C/W
$R_{\theta CS}$	Case-to-Sink, Flat, Greased Surface	—	0.50	—	
$R_{\theta JA}$	Junction-to-Ambient	—	—	62	

## Electrical Characteristics @ T<sub>J</sub> = 25°C (unless otherwise specified)

	Parameter	Min.	Typ.	Max.	Units	Test Conditions
V <sub>(BR)DSS</sub>	Drain-to-Source Breakdown Voltage	-100	—	—	V	V <sub>GS</sub> =0V, I <sub>D</sub> =-250μA
ΔV <sub>(BR)DSS</sub> /ΔT <sub>J</sub>	Breakdown Voltage Temp. Coefficient	—	-0.10	—	V/°C	Reference to 25°C, I <sub>D</sub> =-1mA
R <sub>DS(on)</sub>	Static Drain-to-Source On-Resistance	—	—	0.60	Ω	V <sub>GS</sub> =-10V, I <sub>D</sub> =-4.1A ④
V <sub>GS(th)</sub>	Gate Threshold Voltage	-2.0	—	-4.0	V	V <sub>DS</sub> =V <sub>GS</sub> , I <sub>D</sub> =-250μA
g <sub>fs</sub>	Forward Transconductance	2.0	—	—	S	V <sub>DS</sub> =-50V, I <sub>D</sub> =-4.1A ④
I <sub>DSS</sub>	Drain-to-Source Leakage Current	—	—	-100	μA	V <sub>DS</sub> =-100V, V <sub>GS</sub> =0V
		—	—	-500		V <sub>DS</sub> =-80V, V <sub>GS</sub> =0V, T <sub>J</sub> =150°C
I <sub>GSS</sub>	Gate-to-Source Forward Leakage	—	—	-100	nA	V <sub>GS</sub> =-20V
	Gate-to-Source Reverse Leakage	—	—	100		V <sub>GS</sub> =20V
Q <sub>g</sub>	Total Gate Charge	—	—	18	nC	I <sub>D</sub> =-6.8A
Q <sub>gs</sub>	Gate-to-Source Charge	—	—	3.0		V <sub>DS</sub> =-80V
Q <sub>gd</sub>	Gate-to-Drain ("Miller") Charge	—	—	9.0		V <sub>GS</sub> =-10V See Fig. 6 and 13 ④
t <sub>d(on)</sub>	Turn-On Delay Time	—	9.6	—	ns	V <sub>DD</sub> =-50V
t <sub>r</sub>	Rise Time	—	29	—		I <sub>D</sub> =-6.8A
t <sub>d(off)</sub>	Turn-Off Delay Time	—	21	—		R <sub>G</sub> =18Ω
t <sub>f</sub>	Fall Time	—	25	—		R <sub>D</sub> =7.1Ω See Figure 10 ④
L <sub>D</sub>	Internal Drain Inductance	—	4.5	—	nH	Between lead, 6 mm (0.25in.) from package and center of die contact
L <sub>S</sub>	Internal Source Inductance	—	7.5	—		
C <sub>iss</sub>	Input Capacitance	—	390	—	pF	V <sub>GS</sub> =0V
C <sub>oss</sub>	Output Capacitance	—	170	—		V <sub>DS</sub> =-25V
C <sub>rss</sub>	Reverse Transfer Capacitance	—	45	—		f=1.0MHz See Figure 5

## Source-Drain Ratings and Characteristics

	Parameter	Min.	Typ.	Max.	Units	Test Conditions
I <sub>S</sub>	Continuous Source Current (Body Diode)	—	—	-6.8	A	MOSFET symbol showing the integral reverse p-n junction diode.
I <sub>SM</sub>	Pulsed Source Current (Body Diode) ①	—	—	-27		
V <sub>SD</sub>	Diode Forward Voltage	—	—	-6.3	V	T <sub>J</sub> =25°C, I <sub>S</sub> =-6.8A, V <sub>GS</sub> =0V ④
t <sub>rr</sub>	Reverse Recovery Time	—	98	200	ns	T <sub>J</sub> =25°C, I <sub>F</sub> =-6.8A
Q <sub>rr</sub>	Reverse Recovery Charge	—	0.33	0.66	μC	di/dt=100A/μs ④
t <sub>on</sub>	Forward Turn-On Time	Intrinsic turn-on time is negligible (turn-on is dominated by L <sub>S</sub> +L <sub>D</sub> )				

### Notes:

- ① Repetitive rating; pulse width limited by max. junction temperature (See Figure 11)
- ② V<sub>DD</sub>=-25V, starting T<sub>J</sub>=25°C, L=9.7mH R<sub>G</sub>=25Ω, I<sub>AS</sub>=-6.8A (See Figure 12)
- ③ I<sub>SD</sub>≤-6.8A, di/dt≤110A/μs, V<sub>DD</sub>≤V<sub>(BR)DSS</sub>, T<sub>J</sub>≤175°C
- ④ Pulse width ≤ 300 μs; duty cycle ≤2%.

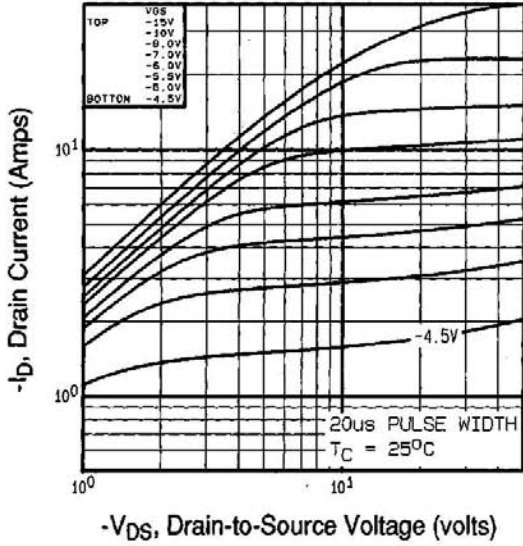


Fig 1. Typical Output Characteristics,  $T_C = 25^\circ\text{C}$

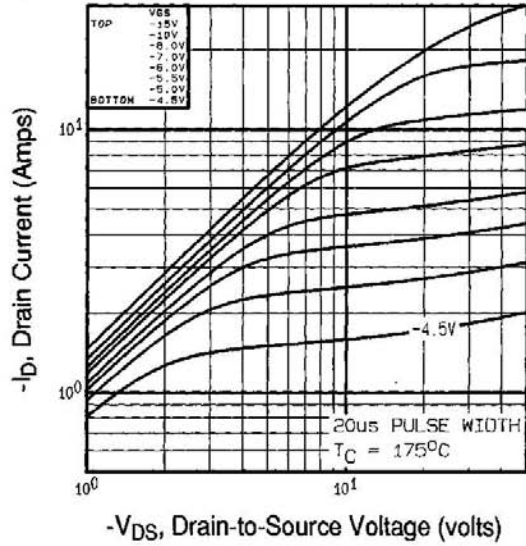


Fig 2. Typical Output Characteristics,  $T_C = 175^\circ\text{C}$

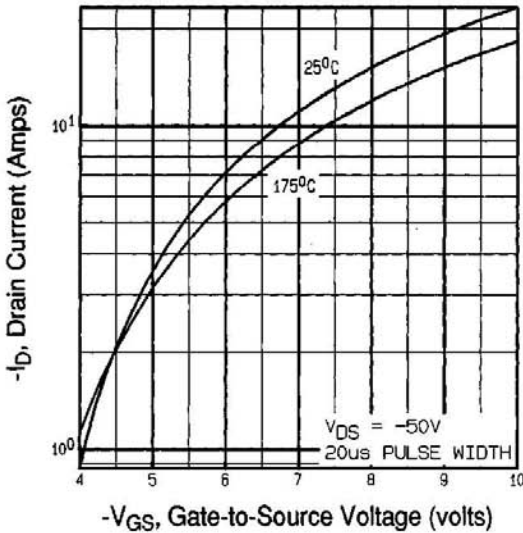


Fig 3. Typical Transfer Characteristics

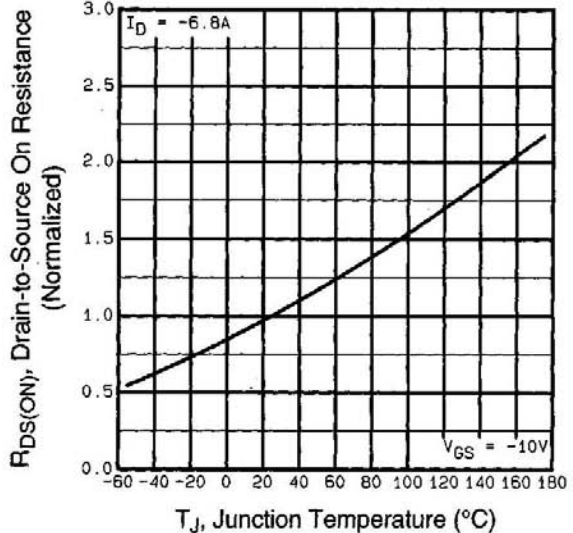
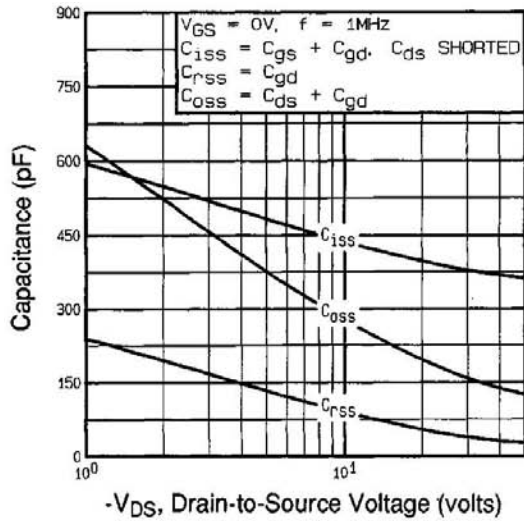


Fig 4. Normalized On-Resistance Vs. Temperature

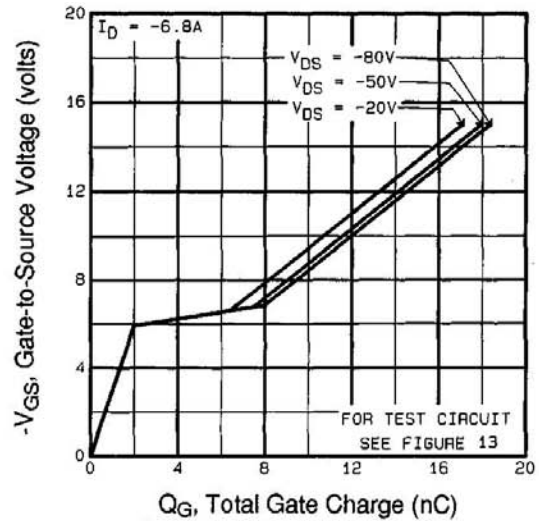


# IRF9520PbF

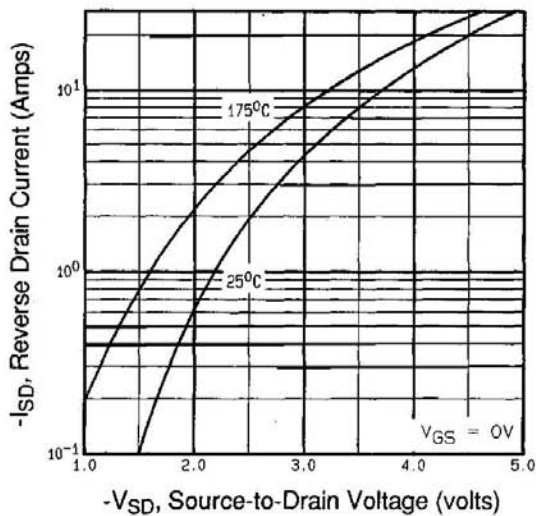
International  
**IR** Rectifier



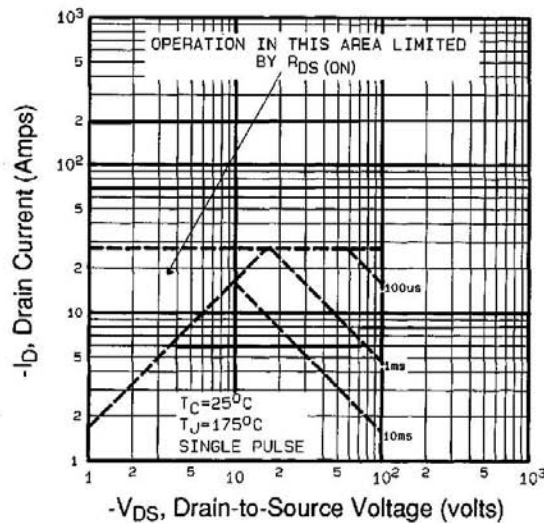
**Fig 5.** Typical Capacitance Vs. Drain-to-Source Voltage



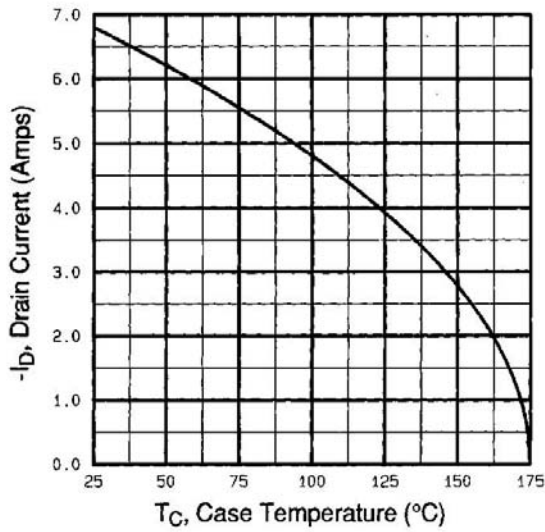
**Fig 6.** Typical Gate Charge Vs. Gate-to-Source Voltage



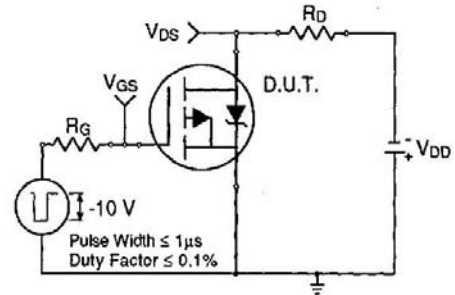
**Fig 7.** Typical Source-Drain Diode Forward Voltage



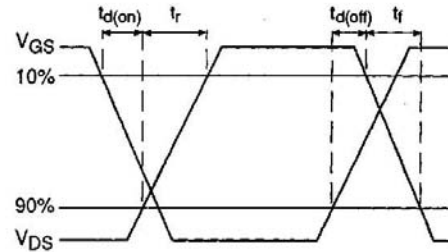
**Fig 8.** Maximum Safe Operating Area



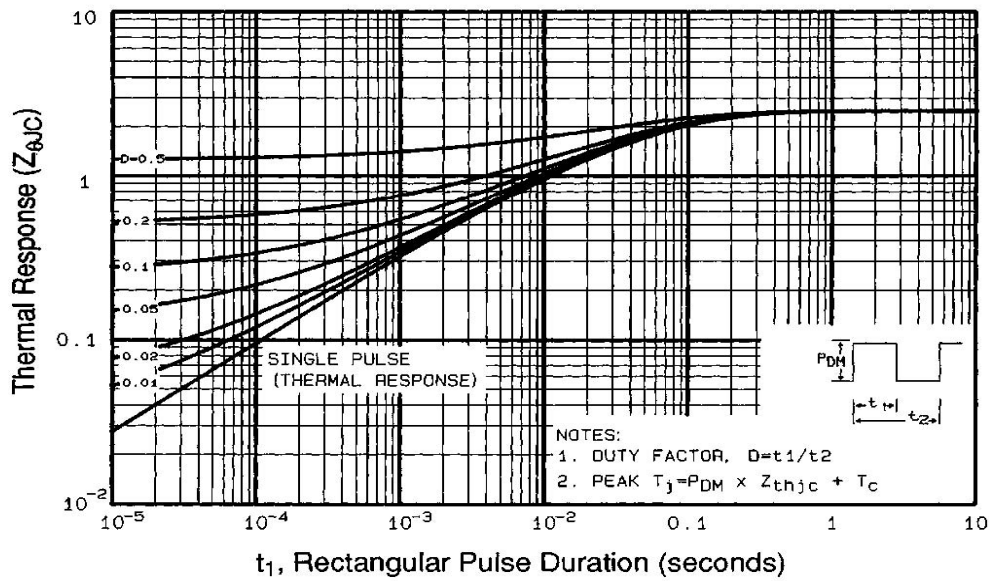
**Fig 9.** Maximum Drain Current Vs. Case Temperature



**Fig 10a.** Switching Time Test Circuit



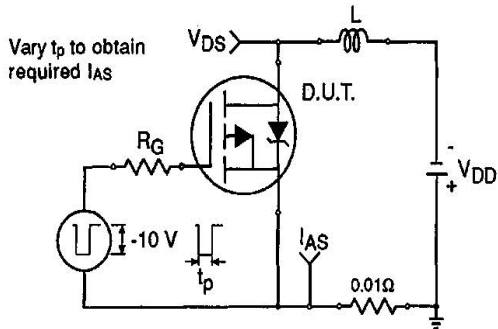
**Fig 10b.** Switching Time Waveforms



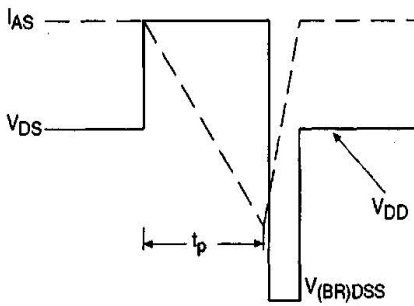
**Fig 11.** Maximum Effective Transient Thermal Impedance, Junction-to-Case  
www.irf.com

# IRF9520PbF

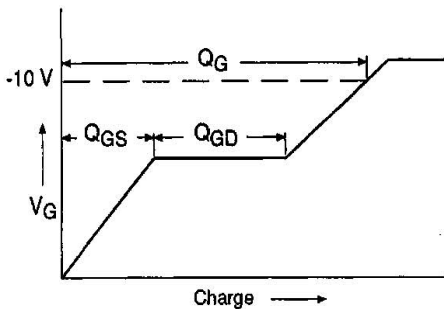
International  
**IR** Rectifier



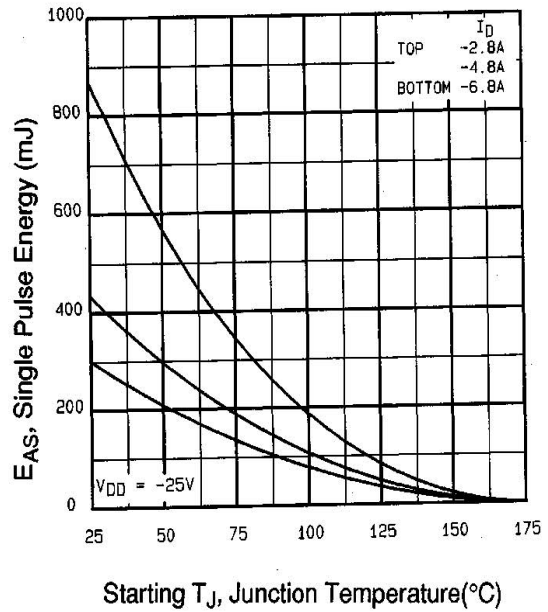
**Fig 12a.** Unclamped Inductive Test Circuit



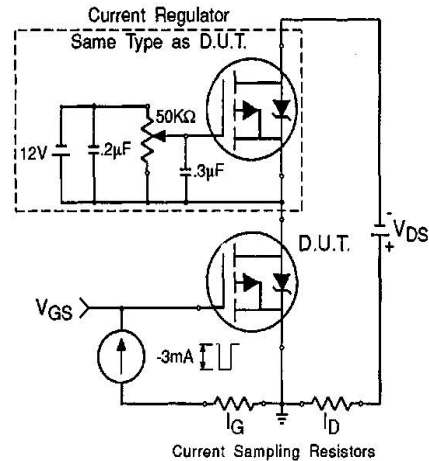
**Fig 12b.** Unclamped Inductive Waveforms



**Fig 13a.** Basic Gate Charge Waveform

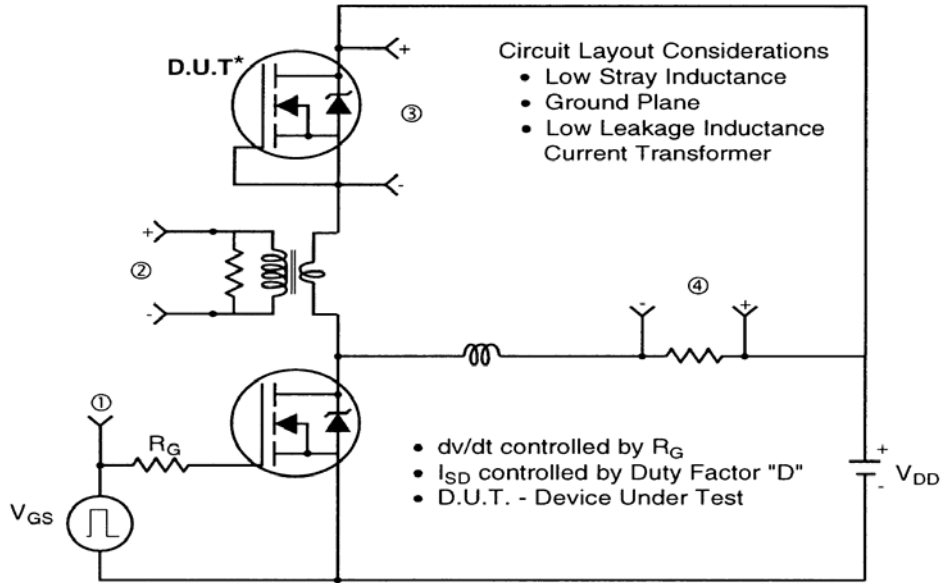


**Fig 12c.** Maximum Avalanche Energy Vs. Drain Current

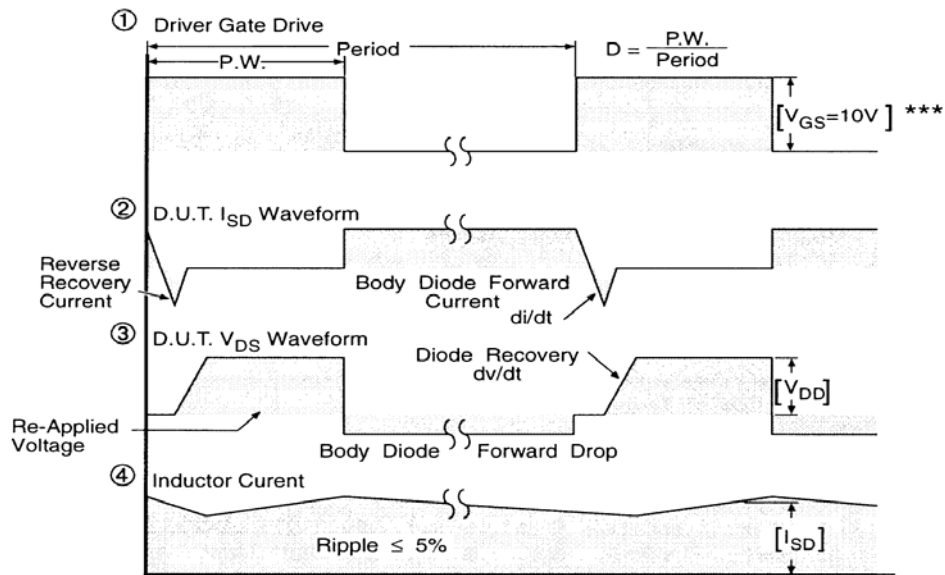


**Fig 13b.** Gate Charge Test Circuit

**Peak Diode Recovery dv/dt Test Circuit**



\* Reverse Polarity of D.U.T for P-Channel



\*\*\*  $V_{GS} = 5.0V$  for Logic Level and 3V Drive Devices

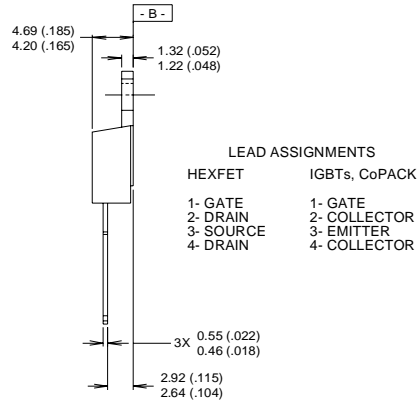
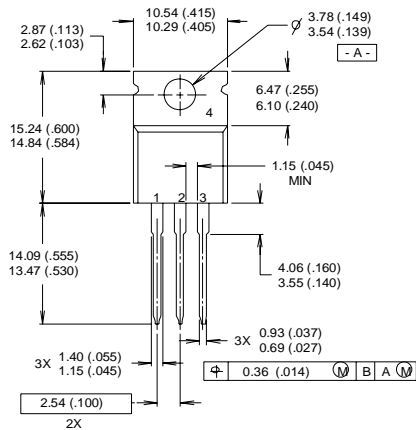
**Fig 14. For P-Channel HEXFETS**

# IRF9520PbF

International  
**IR** Rectifier

## TO-220AB Package Outline

Dimensions are shown in millimeters (inches)



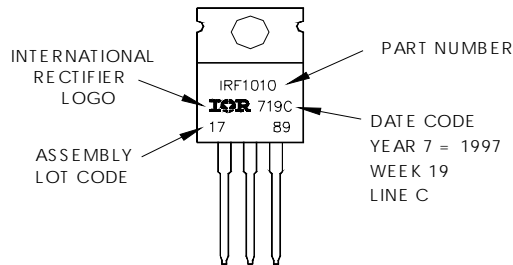
**NOTES:**

- 1 DIMENSIONING & TOLERANCING PER ANSI Y14.5M, 1982.
- 2 CONTROLLING DIMENSION : INCH

- 3 OUTLINE CONFORMS TO JEDEC OUTLINE TO-220AB.
- 4 HEATSINK & LEAD MEASUREMENTS DO NOT INCLUDE BURRS.

## TO-220AB Part Marking Information

EXAMPLE: THIS IS AN IRF1010  
 LOT CODE 1789  
 ASSEMBLED ON WW 19, 1997  
 IN THE ASSEMBLY LINE "C"  
**Note:** "P" in assembly line position indicates "Lead-Free"



Data and specifications subject to change without notice.

International  
**IR** Rectifier

IR WORLD HEADQUARTERS: 233 Kansas St., El Segundo, California 90245, USA Tel: (310) 252-7105

TAC Fax: (310) 252-7903

Visit us at [www.irf.com](http://www.irf.com) for sales contact information. 06/04

[www.irf.com](http://www.irf.com)