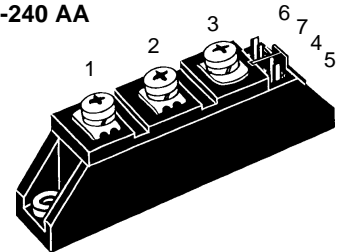

# Thyristor Modules

$I_{TRMS} = 2 \times 40 \text{ A}$   
 $I_{TAVM} = 2 \times 25 \text{ A}$   
 $V_{RRM} = 800-1600 \text{ V}$

$V_{RSM}$	$V_{RRM}$	Type	
$V_{DSM}$	$V_{DRM}$	Version 1 B	Version 8 B
V	V		
900	800	MCC 19-08io1 B	MCC 19-08io8 B
1300	1200	MCC 19-12io1 B	MCC 19-12io8 B
1500	1400	MCC 19-14io1 B	MCC 19-14io8 B
1700	1600	MCC 19-16io1 B	MCC 19-16io8 B

**TO-240 AA**

Symbol	Test Conditions	Maximum Ratings	
$I_{TRMS}$	$T_{VJ} = T_{VJM}$	40	A
	$T_C = 58^\circ\text{C}; 180^\circ \text{ sine}$	25	A
	$T_C = 85^\circ\text{C}; 180^\circ \text{ sine}$	18	A
$I_{TSM}$	$T_{VJ} = 45^\circ\text{C}; V_R = 0$	t = 10 ms (50 Hz), sine	400 A
		t = 8.3 ms (60 Hz), sine	420 A
$\int i^2 dt$	$T_{VJ} = 45^\circ\text{C}; V_R = 0$	t = 10 ms (50 Hz), sine	800 A <sup>2</sup> s
		t = 8.3 ms (60 Hz), sine	730 A <sup>2</sup> s
$(di/dt)_{cr}$	$T_{VJ} = T_{VJM}; f = 50 \text{ Hz}, t_p = 200 \mu\text{s}$	repetitive, $I_T = 45 \text{ A}$	150 A/ $\mu\text{s}$
	$V_D = 2/3 V_{DRM}; I_G = 0.45 \text{ A}; di_G/dt = 0.45 \text{ A}/\mu\text{s}$	non repetitive, $I_T = I_{TAVM}$	500 A/ $\mu\text{s}$
$(dv/dt)_{cr}$	$T_{VJ} = T_{VJM}; R_{GK} = \infty; \text{method 1 (linear voltage rise)}$	$V_{DR} = 2/3 V_{DRM}$	1000 V/ $\mu\text{s}$
$P_{GM}$	$T_{VJ} = T_{VJM}; I_T = I_{TAVM}$	$t_p = 30 \mu\text{s}$	10 W
		$t_p = 300 \mu\text{s}$	5 W
$P_{GAV}$			0.5 W
$V_{RGM}$			10 V
$T_{VJ}$		-40...+125	°C
$T_{VJM}$		125	°C
$T_{stg}$		-40...+125	°C
$V_{ISOL}$	50/60 Hz, RMS	t = 1 min	3000 V~
	$I_{ISOL} \leq 1 \text{ mA}$	t = 1 s	3600 V~
$M_d$	Mounting torque (M5)		2.5-4.0/22-35 Nm/lb.in.
	Terminal connection torque (M5)		2.5-4.0/22-35 Nm/lb.in.
Weight	Typical including screws		90 g

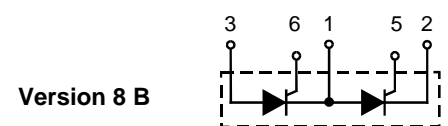
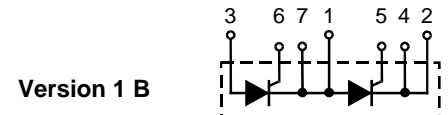
**Features**

- International standard package, JEDEC TO-240 AA
- Direct copper bonded Al<sub>2</sub>O<sub>3</sub> -ceramic base plate
- Planar passivated chips
- Isolation voltage 3600 V~
- UL registered, E 72873
- Gate-cathode twin pins for version 1B

**Applications**

- DC motor control
- Softstart AC motor controller
- Light, heat and temperature control

**Advantages**

- Space and weight savings
- Simple mounting with two screws
- Improved temperature and power cycling
- Reduced protection circuits

Data according to IEC 60747 and refer to a single thyristor unless otherwise stated. IXYS reserves the right to change limits, test conditions and dimensions

Symbol	Test Conditions	Characteristic Values
$I_{RRM}, I_{DRM}$	$T_{VJ} = T_{VJM}; V_R = V_{RRM}; V_D = V_{DRM}$	3 mA
$V_T$	$I_T = 80 \text{ A}; T_{VJ} = 25^\circ\text{C}$	2.05 V
$V_{T0}$	For power-loss calculations only ( $T_{VJ} = 125^\circ\text{C}$ )	0.85 V
$r_T$		18 mΩ
$V_{GT}$	$V_D = 6 \text{ V}; T_{VJ} = 25^\circ\text{C}$	1.5 V
	$T_{VJ} = -40^\circ\text{C}$	1.6 V
$I_{GT}$	$V_D = 6 \text{ V}; T_{VJ} = 25^\circ\text{C}$	100 mA
	$T_{VJ} = -40^\circ\text{C}$	200 mA
$V_{GD}$	$T_{VJ} = T_{VJM}; V_D = 2/3 V_{DRM}$	0.2 V
$I_{GD}$		10 mA
$I_L$	$T_{VJ} = 25^\circ\text{C}; t_p = 10 \mu\text{s}; V_D = 6 \text{ V}$ $I_G = 0.45 \text{ A}; di_G/dt = 0.45 \text{ A}/\mu\text{s}$	450 mA
$I_H$	$T_{VJ} = 25^\circ\text{C}; V_D = 6 \text{ V}; R_{GK} = \infty$	200 mA
$t_{gd}$	$T_{VJ} = 25^\circ\text{C}; V_D = 1/2 V_{DRM}$ $I_G = 0.45 \text{ A}; di_G/dt = 0.45 \text{ A}/\mu\text{s}$	2 μs
$t_q$	$T_{VJ} = T_{VJM}; I_T = 20 \text{ A}, t_p = 200 \mu\text{s}; -di/dt = 10 \text{ A}/\mu\text{s}$ typ. $V_R = 100 \text{ V}; dv/dt = 20 \text{ V}/\mu\text{s}; V_D = 2/3 V_{DRM}$	150 μs
$Q_S$	$T_{VJ} = T_{VJM}; I_T = 25 \text{ A}, -di/dt = 0.64 \text{ A}/\mu\text{s}$	50 μC
$I_{RM}$		6 A
$R_{thJC}$	per thyristor; DC current per module	1.3 K/W
$R_{thJK}$	per thyristor; DC current per module	0.65 K/W
	other values see Fig. 8/9	1.5 K/W
		0.75 K/W
$d_s$	Creepage distance on surface	12.7 mm
$d_A$	Strike distance through air	9.6 mm
$a$	Maximum allowable acceleration	50 m/s <sup>2</sup>

Optional accessories for module-type MCC 19 version 1 B

Keyed gate/cathode twin plugs with wire length = 350 mm, gate = yellow, cathode = red

Type ZY 200L (L = Left for pin pair 4/5) } UL 758, style 1385,  
 Type ZY 200R (R = right for pin pair 6/7) } CSA class 5851, guide 460-1-1

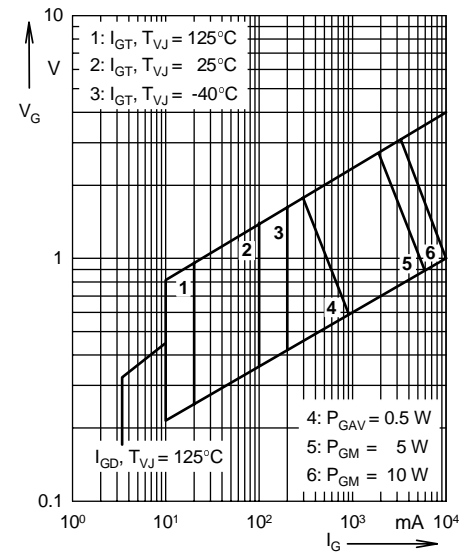

Fig. 1 Gate trigger characteristics

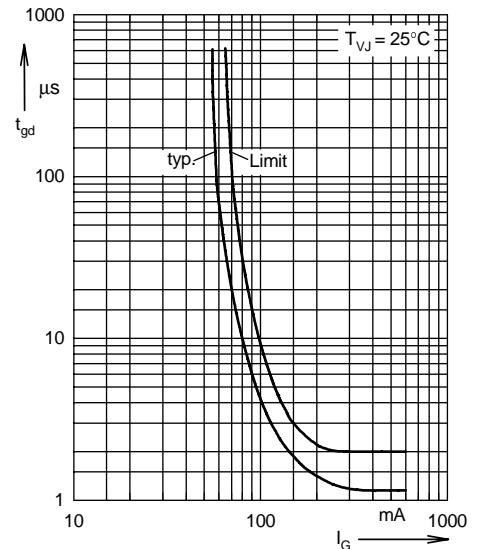
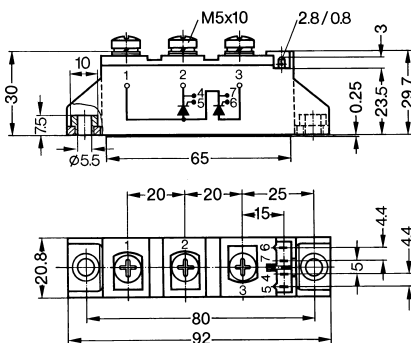

Fig. 2 Gate trigger delay time

### Dimensions in mm (1 mm = 0.0394")

#### Version 1 B



#### Version 8 B

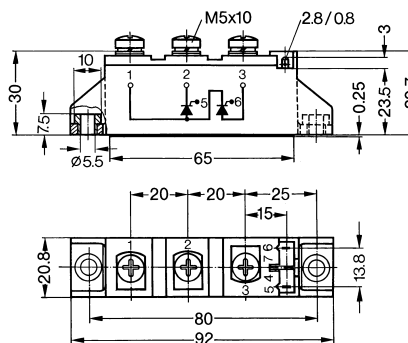

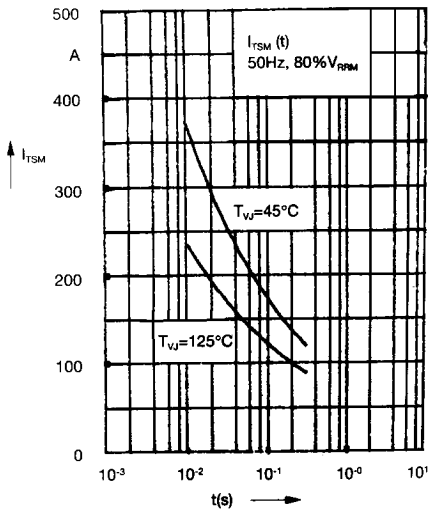

Fig. 3 Surge overload current  
 $I_{TSM}$ : Crest value,  $t$ : duration

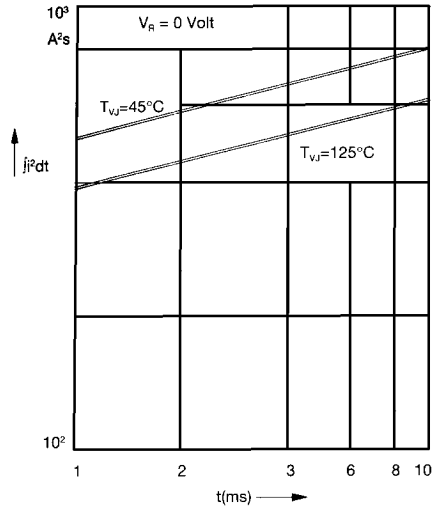

Fig. 4  $\int i^2 dt$  versus time (1-10 ms)

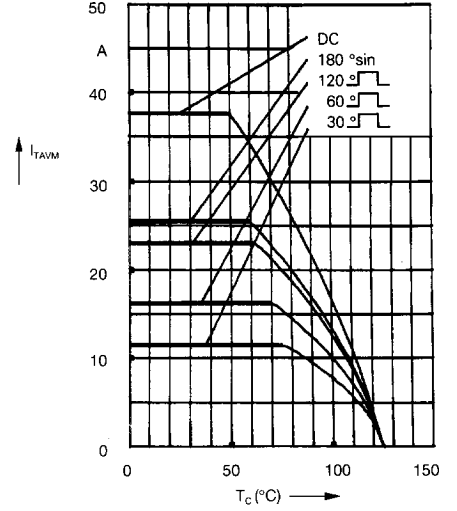

Fig. 4a Maximum forward current at case temperature

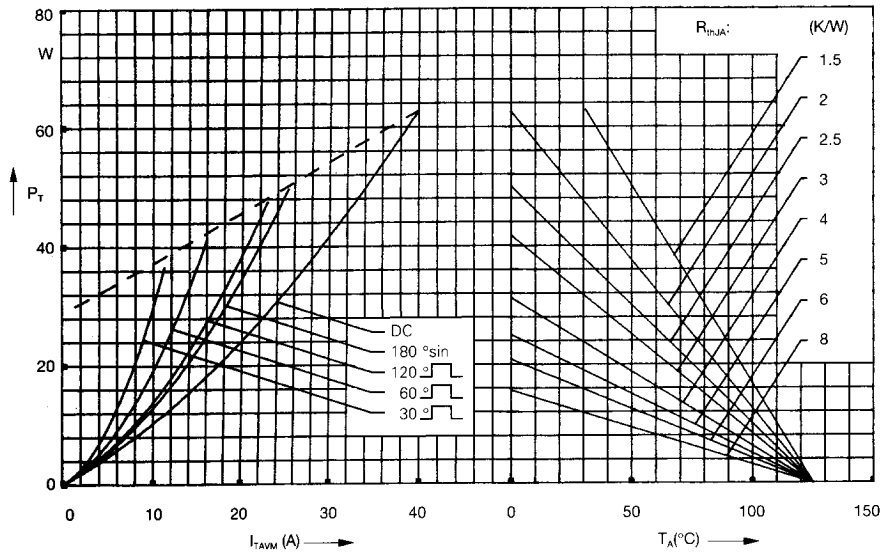

Fig. 5 Power dissipation versus on-state current and ambient temperature (per thyristor)

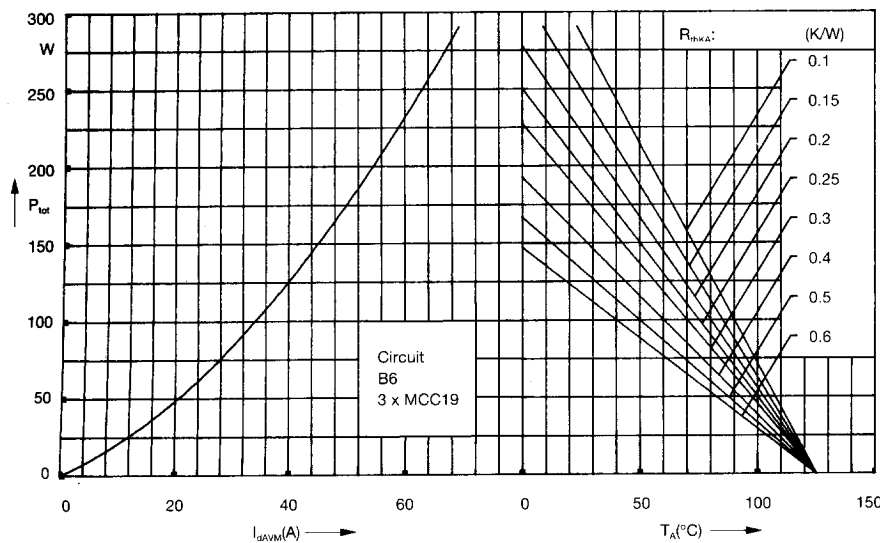

Fig. 6 Three phase rectifier bridge: Power dissipation versus direct output current and ambient temperature

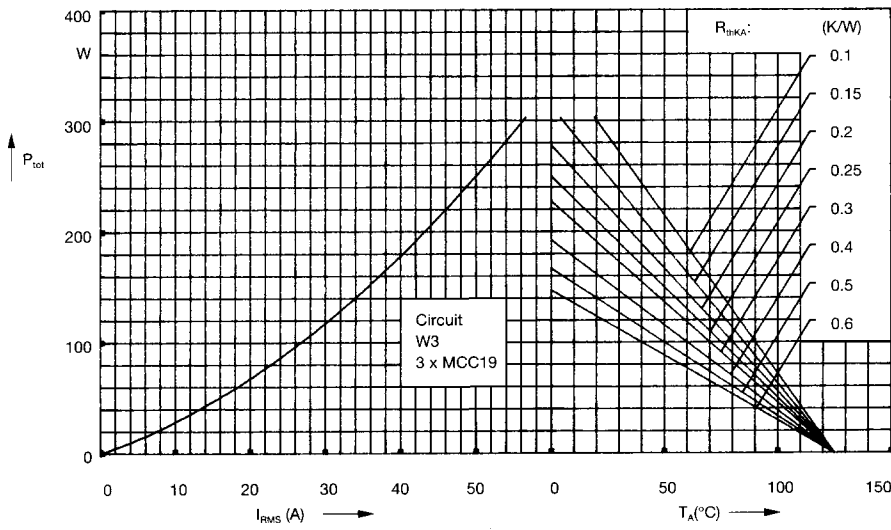

Fig. 7 Three phase AC-controller: Power dissipation versus RMS output current and ambient temperature

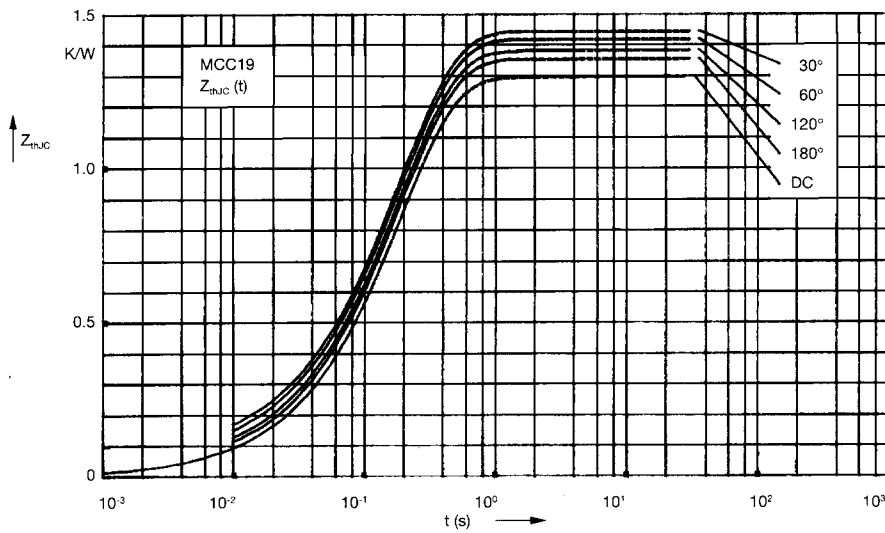

Fig. 8 Transient thermal impedance junction to case (per thyristor)

$R_{thJC}$  for various conduction angles  $d$ :

$d$	$R_{thJC}$ (K/W)
DC	1.3
180°	1.35
120°	1.39
60°	1.42
30°	1.45

Constants for  $Z_{thJC}$  calculation:

$i$	$R_{thi}$ (K/W)	$t_i$ (s)
1	0.018	0.0033
2	0.041	0.0216
3	1.241	0.191

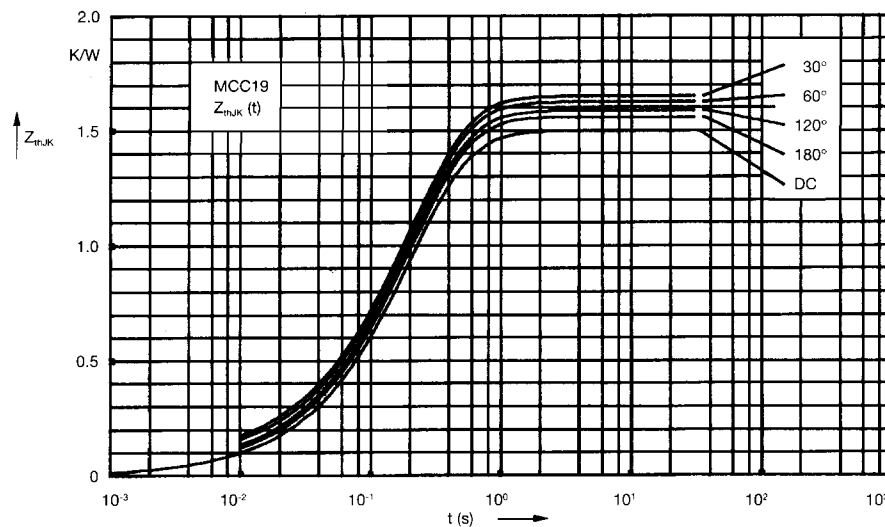

Fig. 9 Transient thermal impedance junction to heatsink (per thyristor)

$R_{thJK}$  for various conduction angles  $d$ :

$d$	$R_{thJK}$ (K/W)
DC	1.5
180°	1.55
120°	1.59
60°	1.62
30°	1.65

Constants for  $Z_{thJK}$  calculation:

$i$	$R_{thi}$ (K/W)	$t_i$ (s)
1	0.018	0.0033
2	0.041	0.0216
3	1.241	0.191
4	0.2	0.46