

## DIODE MODULE (F.R.D.)

# MDF(R)250A-L/M

MDF(R)250A-L/M and MDR150-L/M are high speed (fast recovery) diode with flat mounting base which is designed for switching application of high power.

- $I_{F(AV)}$  250A  $V_{RRM}$ =200/300/400V
- Easy Construction with Anode (F) Type and Cathode (R) Type
- [ MDF:anode to terminal (normal polarity) ]
- [ MDR:cathode to terminal ]
- Reverse Recovery Time ( $t_{rr}$ ) L Type: 450ns, M Type: 550ns
- High Reliability by Glass passivated Chips
- Non isolated type

### (Applications)

Switching Power Supply.  
Inverter Welding Power Supply

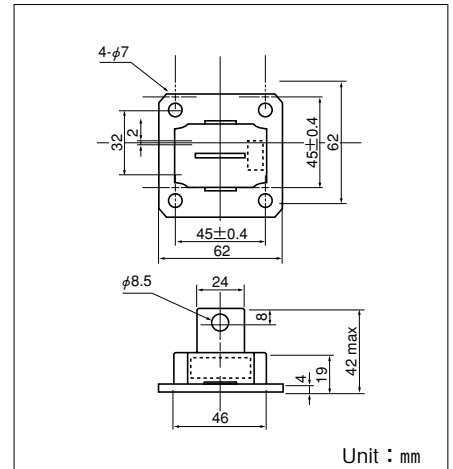
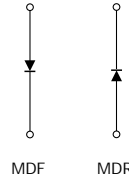

### Maximum Ratings

Symbol	Item	Ratings			Unit
		MDF(R)250A20L/M	MDF(R)250A30L/M	MDF(R)250A40L/M	
$V_{RRM}$	Repetitive Peak Reverse Voltage	200	300	400	V
$V_{RSM}$	Non-Repetitive Peak Reverse Voltage	240	360	480	V
$V_{R(DC)}$	D.C. Reverse Voltage	160	240	320	V

Symbol	Item	Conditions	Ratings	Unit	
$I_{F(AV)}$	Average Forward Current	Single phase, half wave, 180° conduction, $T_c$ :L/M 83°/85°C	250	A	
$I_{F(RSM)}$	R.M.S. Forward Current	Single phase, half wave, 180° conduction, $T_c$ :L/M 83°/85°C	390	A	
$I_{FMS}$	Surge Forward Current	1/2 cycle, 50/60Hz, peak value, non-repetitive	4000/4500	A	
$I^2t$	$I^2t$	Value for one cycle of surge current	84000	A <sup>2</sup> S	
$T_j$	Operating Junction Temperature		-30 to +150	°C	
$T_{stg}$	Storage Temperature		-30 to +125	°C	
	Mounting Torque	Mounting (M6)	Recommended Value 2.5-3.9 (25-40)	4.7 (48)	N·m (kgf·cm)
		Terminal (M8)	Recommended Value 8.8-10 (90-105)	11 (115)	
	Mass	Typical Value	170	g	

### Electrical Characteristics

Symbol	Item	Conditions	Ratings	Unit	
$I_{RRM}$	Repetitive Peak Reverse Current (max.)	at $V_{RRM}$ , single phase, half wave, $T_j=150^\circ\text{C}$	60	mA	
$V_{FM}$	Forward Voltage Drop (max.)	Foward current 800A, $T_j=25^\circ\text{C}$ Inst. measurement	L	1.4	V
			M	1.3	
$R_{th(j-c)}$	Thermal Impedance (max.)	Junction to case	0.2	°C/W	
$t_{rr}$	Reverse Recovery Time (max.)	$T_j=25^\circ\text{C}$ , $I_F=2\text{A}$ , $-di/dt=20\text{A}/\mu\text{s}$	L	450	ns
			M	550	

## M Type

### Maximum Forward Characteristics

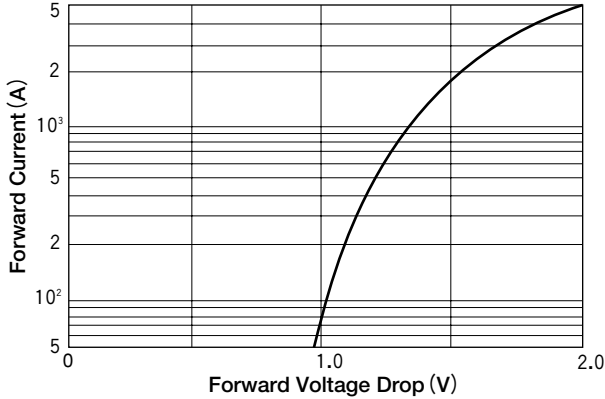

### Average Forward Current vs. Power Dissipation

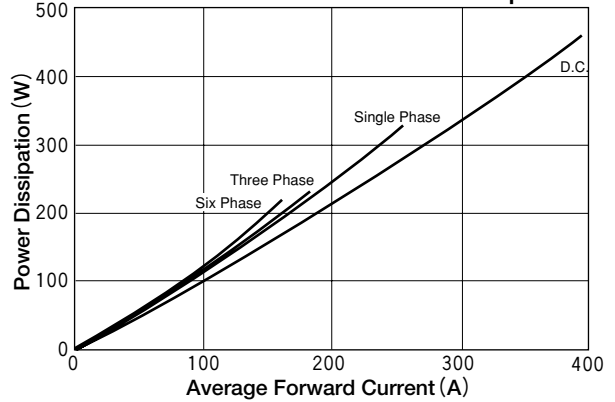

### Average Forward Current vs. Allowable Case Temperature

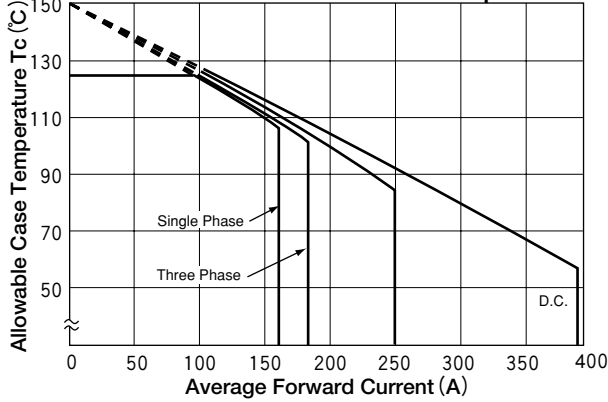

### Cycle Surge Current Rating (Non-Repetitive)

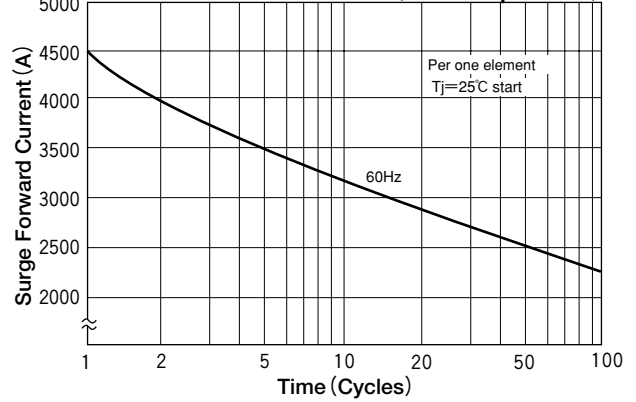

### Transient Thermal Impedance

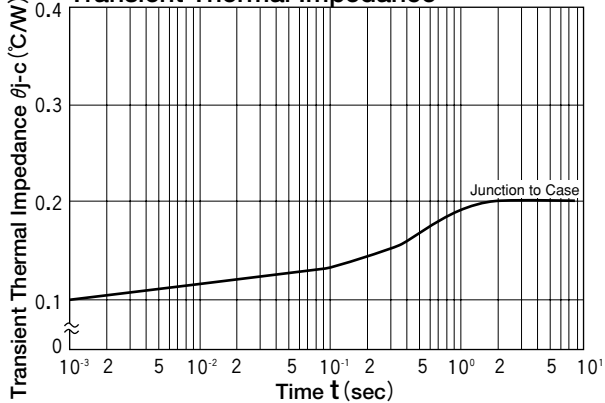

## L Type

### Maximum Forward Characteristics

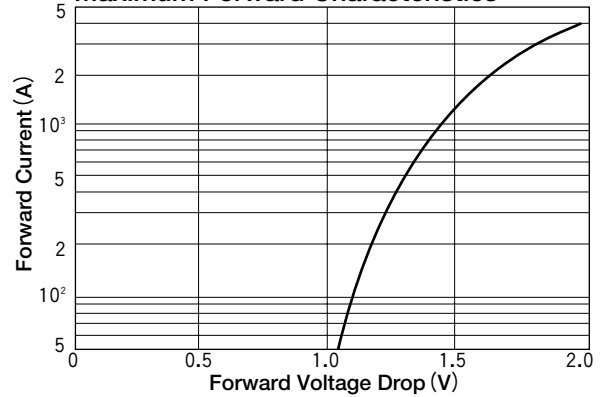

### Average Forward Current vs. Power Dissipation

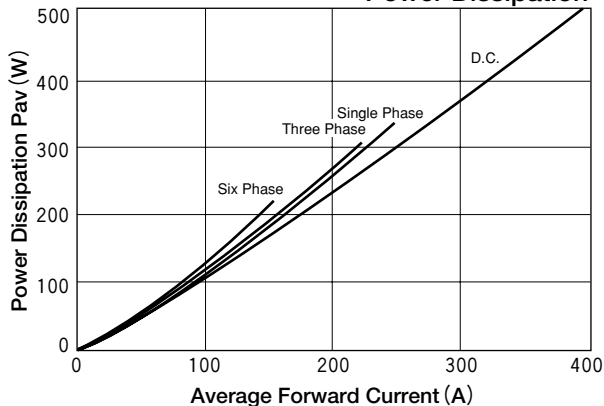

### Average Forward Current vs. Allowable Case Temperature

