

Fast Recovery Epitaxial Diode (FRED) Module

MEA 95-06 DA
MEK 95-06 DA
MEE 95-06 DA

V_{RRM} = 600 V
I_{FAV} = 95 A
t_{rr} = 250 ns

| V _{RSM} V | V _{RRM} V | Type |
|-----------------------|-----------------------|---|
| 600 | 600 | <div style="display: flex; justify-content: space-around;"> <div style="text-align: center;"> <p>MEA95-06 DA</p> </div> <div style="text-align: center;"> <p>MEK 95-06 DA</p> </div> <div style="text-align: center;"> <p>MEE 95-06 DA</p> </div> </div> |

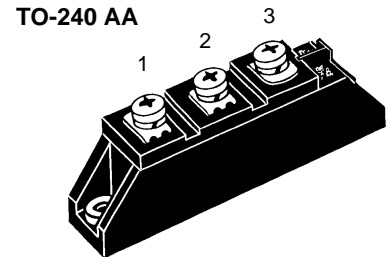

| Symbol | Test Conditions | Maximum Ratings |
|--------------------|--|-----------------------|
| I _{FRMS} | T _{case} = 75°C | 142 A |
| I _{FAV} ① | T _{case} = 75°C; rectangular, d = 0.5 | 95 A |
| I _{FRM} | t _p < 10 μs; rep. rating, pulse width limited by T _{VJM} | TBD A |
| I _{FSM} | T _{VJ} = 45°C; t = 10 ms (50 Hz), sine | 1200 A |
| | t = 8.3 ms (60 Hz), sine | 1300 A |
| | T _{VJ} = 150°C; t = 10 ms (50 Hz), sine | 1080 A |
| | t = 8.3 ms (60 Hz), sine | 1170 A |
| I ² t | T _{VJ} = 45°C; t = 10 ms (50 Hz), sine | 7200 A ² s |
| | t = 8.3 ms (60 Hz), sine | 7100 A ² s |
| | T _{VJ} = 150°C; t = 10 ms (50 Hz), sine | 5800 A ² s |
| | t = 8.3 ms (60 Hz), sine | 5700 A ² s |
| T _{VJ} | | -40...+150 °C |
| T _{stg} | | -40...+125 °C |
| T _{Hmax} | | 110 °C |
| P _{tot} | T _{case} = 25°C | 280 W |
| V _{ISOL} | 50/60 Hz, RMS t = 1 min | 3000 V~ |
| | I _{ISOL} ≤ 1 mA t = 1 s | 3600 V~ |
| M _d | Mounting torque (M5) | 2.5-4/22-35 Nm/lb.in. |
| | Terminal connection torque (M5) | 2.5-4/22-35 Nm/lb.in. |
| d _s | Creep distance on surface | 12.7 mm |
| d _A | Strike distance through air | 9.6 mm |
| a | Maximum allowable acceleration | 50 m/s ² |
| Weight | | 90 g |

Features

- International standard package with DCB ceramic base plate
- Planar passivated chips
- Short recovery time
- Low switching losses
- Soft recovery behaviour
- Isolation voltage 3600 V~
- UL registered E 72873

Applications

- Antiparallel diode for high frequency switching devices
- Free wheeling diode in converters and motor control circuits
- Inductive heating and melting
- Uninterruptible power supplies (UPS)
- Ultrasonic cleaners and welders

Advantages

- High reliability circuit operation
- Low voltage peaks for reduced protection circuits
- Low noise switching
- Low losses

Dimensions in mm (1 mm = 0.0394")

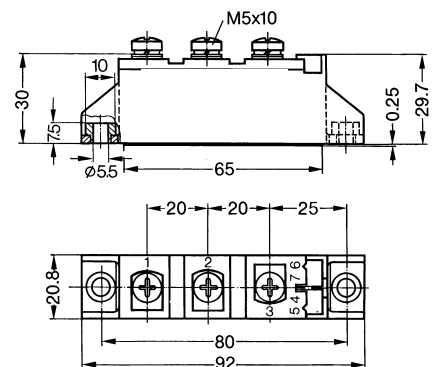

① I_{FAV} rating includes reverse blocking losses at T_{VJM}, V_R = 0.6 V_{RRM}, duty cycle d = 0.5
Data according to IEC 60747
IXYS reserves the right to change limits, test conditions and dimensions

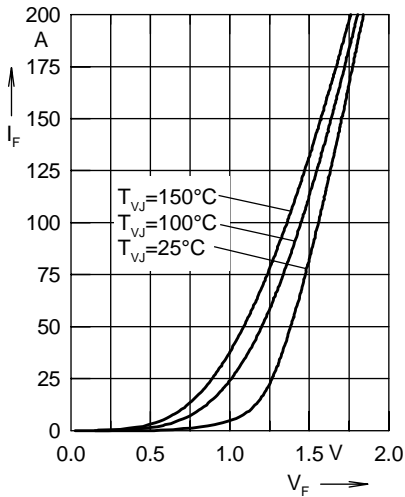

Fig. 1 Forward current I_F versus voltage drop V_F per leg

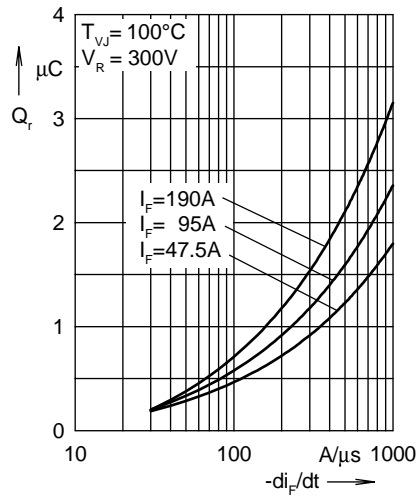

Fig. 2 Reverse recovery charge Q_r versus $-di_F/dt$

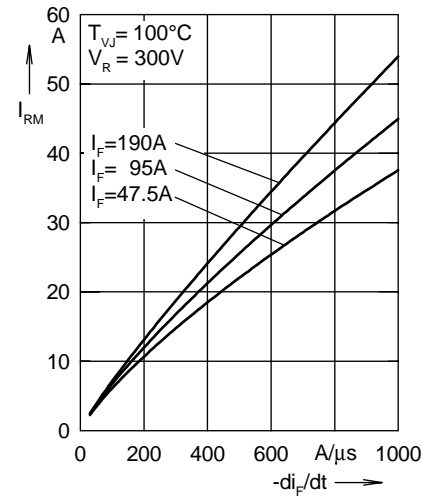

Fig. 3 Peak reverse current I_{RM} versus $-di_F/dt$

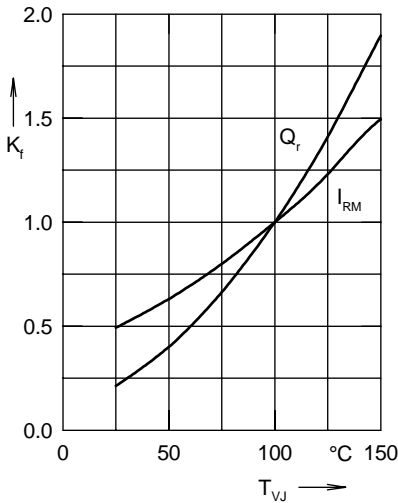

Fig. 4 Dynamic parameters Q_r , I_{RM} versus junction temperature T_{VJ}

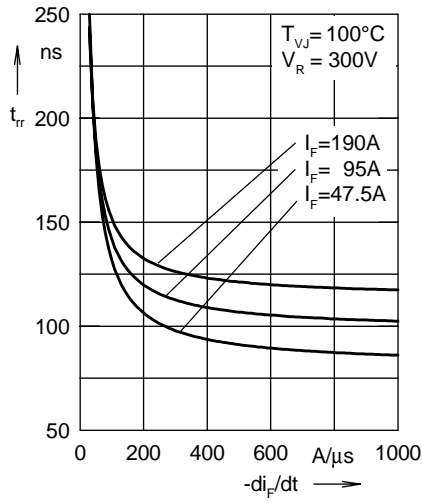

Fig. 5 Recovery time t_{rr} versus $-di_F/dt$

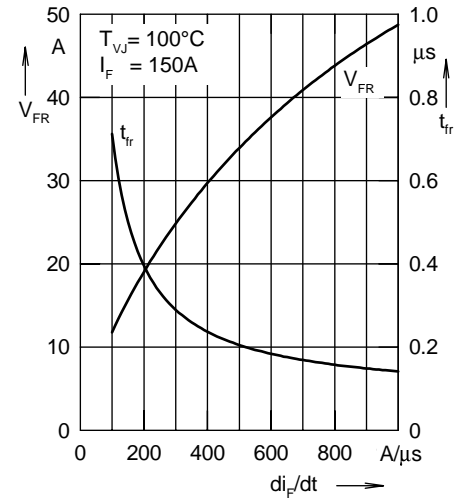

Fig. 6 Peak forward voltage V_{FR} and t_{fr} versus di_F/dt

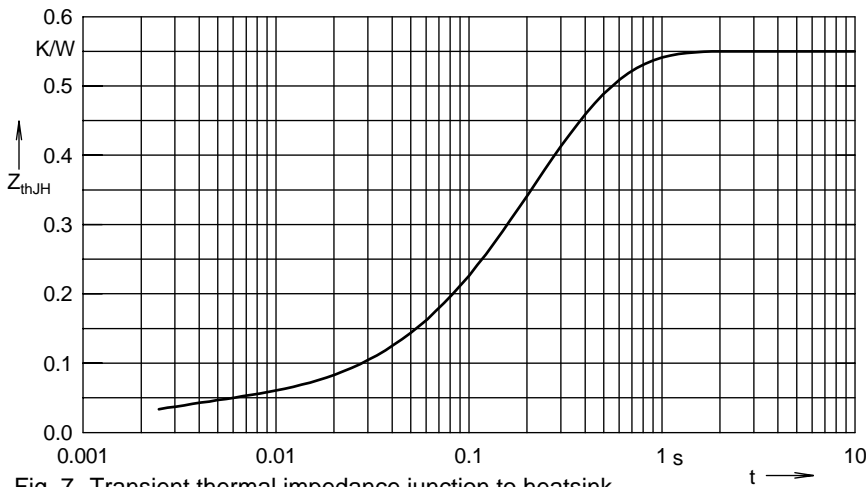

Fig. 7 Transient thermal impedance junction to heatsink

Constants for Z_{thJH} calculation:

| i | R_{thi} (K/W) | t_i (s) |
|---|-----------------|-----------|
| 1 | 0.037 | 0.002 |
| 2 | 0.138 | 0.134 |
| 3 | 0.093 | 0.25 |
| 4 | 0.282 | 0.274 |