

THYRISTOR MODULE

PCH20012 PCH20016

200A / 1200 to 1600V

FEATURES

- * Isolated Base
- * Thyristor and Diode Cathode Common Circuit
- * High Surge Capability
- * UL Recognized, File No. E187184

TYPICAL APPLICATIONS

- * Rectified For General Use

OUTLINE DRAWING

PCH

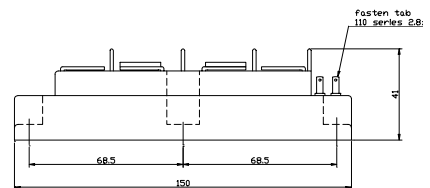
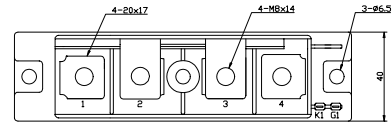
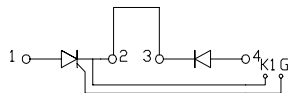

Maximum Ratings

Approx Net Weight:480g

Parameter	Symbol	Grade		Unit
		PCH20012	PCH20016	
Repetitive Peak Off-State Voltage	V_{DRM}	1200	1600	V
Non Repetitive Peak Off-State Voltage	V_{DSM}	1300	1700	V
Repetitive Peak Reverse Voltage	V_{RRM}	1200	1600	V
Non Repetitive Peak Reverse Voltage	V_{RSM}	1300	1700	V

Parameter		Conditions	Max Rated Value	Unit	
Average Rectified Output Current	$I_{O(AV)}$	50Hz Half Sine Wave condition $T_c=75^\circ C$	200	A	
RMS On-State Current	$I_{T(RMS)}$		314	A	
Surge On-State Current	I_{TSM}	50 Hz Half Sine Wave, 1Pulse Non-Repetitive	4000	A	
I Squared t	I^2t	2msec to 10msec	80000	A^2s	
Critical Rate of Turned-On Current	di/dt	$V_D=2/3V_{DRM}$, $I_{TM}=2 \cdot I_o$, $T_j=125^\circ C$ $I_G=300mA$, $di/dt=0.2A/\mu s$	100	$A/\mu s$	
Peak Gate Power	P_{GM}		5	W	
Average Gate Power	$P_{G(AV)}$		1	W	
Peak Gate Current	I_{GM}		2	A	
Peak Gate Voltage	V_{GM}		10	V	
Peak Gate Reverse Voltage	V_{RGM}		5	V	
Operating Junction Temperature Range	T_{jw}		-40 to +125	$^\circ C$	
Storage Temperature Range	T_{stg}		-40 to +125	$^\circ C$	
Isolation Voltage	Viso	Base Plate to Terminals, AC1min	2500	V	
Mounting torque	Case mounting	Ftor	M6 Screw	2.5 to 3.5	N.m
	Terminals		M8 Screw	9.0 to 10.0	

Value per 1 Arm

Electrical • Thermal Characteristics

Characteristics	Symbol	Test Conditions	Maximum Value.			Unit
			Min.	Typ.	Max.	
Peak Off-State Current	I_{DM}	$V_{DM} = V_{DRM}, T_j = 125^\circ\text{C}$			80	mA
Peak Reverse Current	I_{RM}	$V_{RM} = V_{RRM}, T_j = 125^\circ\text{C}$			80	mA
Peak Forward Voltage	V_{TM}	$I_{TM} = 600\text{A}, T_j = 25^\circ\text{C}$			1.28	V
Gate Current to Trigger	I_{GT}	$V_D = 6\text{V}, I_T = 1\text{A}$	$T_j = -40^\circ\text{C}$		300	mA
			$T_j = 25^\circ\text{C}$		150	
			$T_j = 125^\circ\text{C}$		80	
Gate Voltage to Trigger	V_{GT}	$V_D = 6\text{V}, I_T = 1\text{A}$	$T_j = -40^\circ\text{C}$		5	V
			$T_j = 25^\circ\text{C}$		3	
			$T_j = 125^\circ\text{C}$		2	
Gate Non-Trigger Voltage	V_{GD}	$V_D = 2/3V_{DRM}, T_j = 125^\circ\text{C}$	0.25			V
Critical Rate of Rise of Off-State Voltage	dv/dt	$V_D = 2/3V_{DRM}, T_j = 125^\circ\text{C}$	500			V/ μs
Turn-Off Time	tq	$I_{TM} = I_O, V_D = 2/3V_{DRM}$ $dv/dt = 20\text{V}/\mu\text{s}, V_R = 100\text{V}$ $-di/dt = 20\text{A}/\mu\text{s}, T_j = 125^\circ\text{C}$		100		μs
Turn-On Time	tgt	$V_D = 2/3V_{DRM}, T_j = 125^\circ\text{C}$ $I_G = 300\text{mA}, di_G/dt = 0.2\text{A}/\mu\text{s}$		6		μs
Delay Time	td			2		μs
Rise Time	tr			4		μs
Latching Current	I_L	$T_j = 25^\circ\text{C}$		150		mA
Holding Current	I_H	$T_j = 25^\circ\text{C}$		100		
Thermal Resistance	Rth(j-c)	Junction to Case			0.2	$^\circ\text{C}/\text{W}$
	Rth(c-f)	Base Plate to Heat Sink with Thermal Compound			0.1	

Value Per 1Arm

PCH2001x OUTLINE DRAWING (Dimensions in mm)

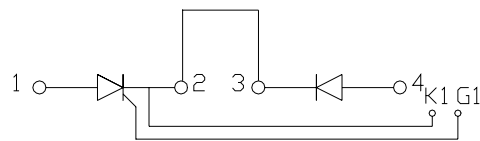
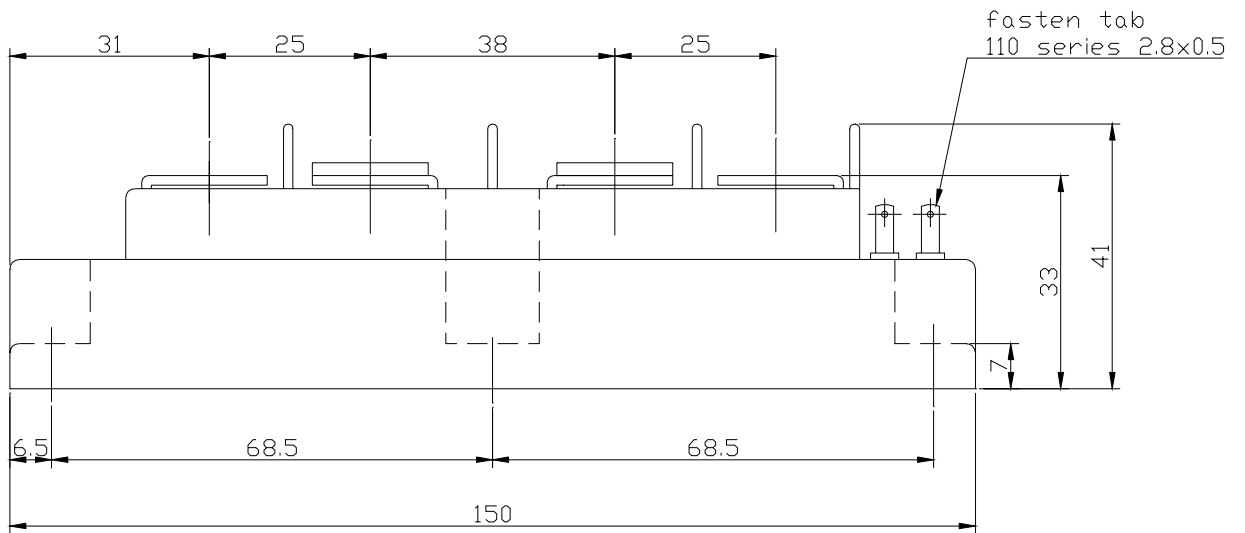
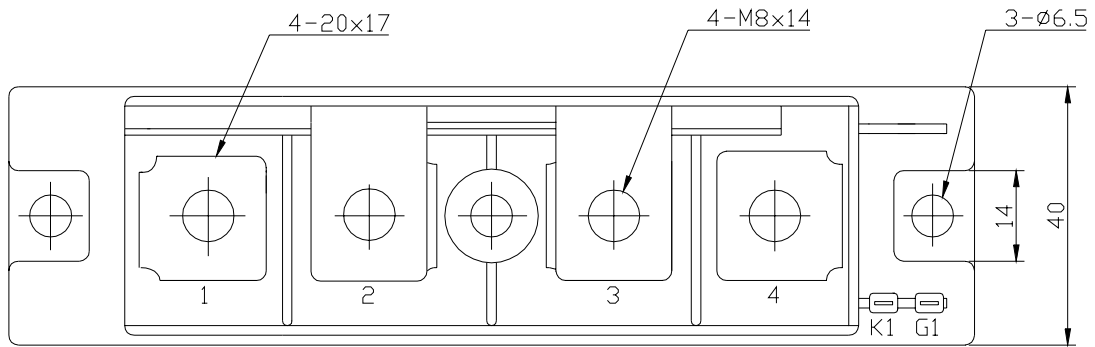

オン電圧特性
ON-STATE CURRENT VS. VOLTAGE

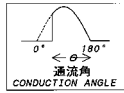
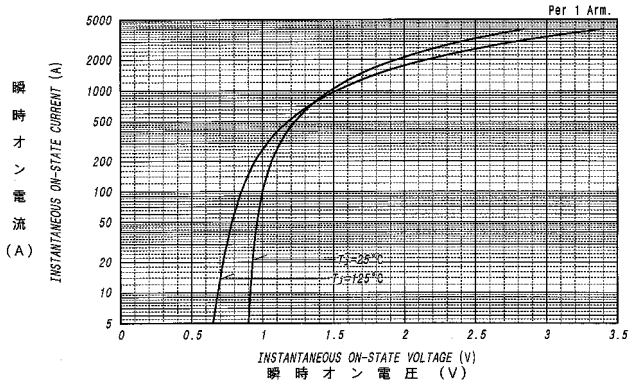

平均オン電力損失特性
AVERAGE ON-STATE POWER DISSIPATION

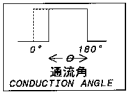
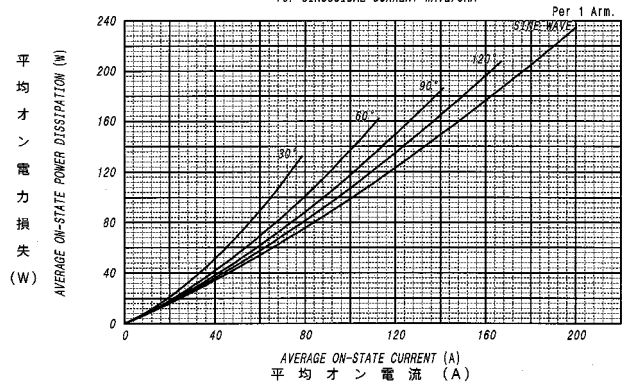

平均オン電力損失特性
AVERAGE ON-STATE POWER DISSIPATION

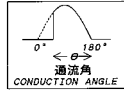
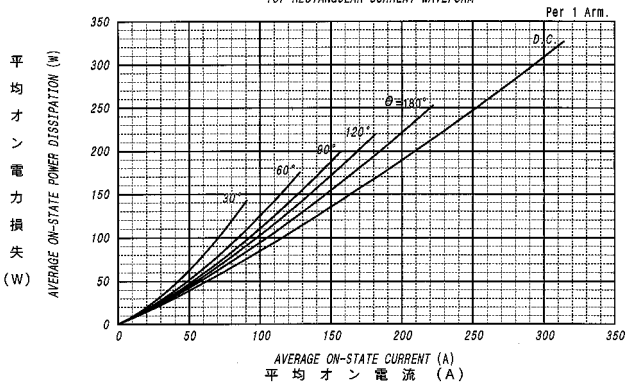

平均オン電流 - ケース温度定格
AVERAGE ON-STATE CURRENT VS. CASE TEMPERATURE

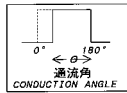
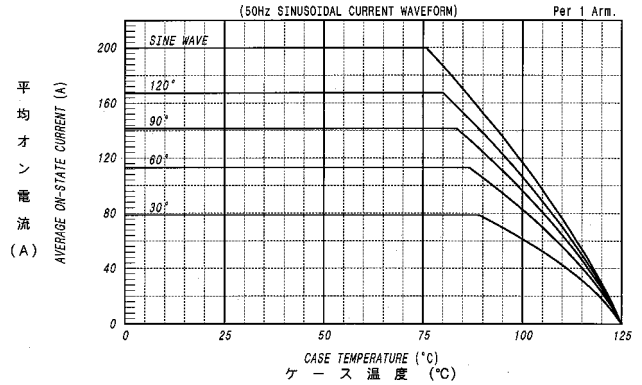

平均オン電流 - ケース温度定格
AVERAGE ON-STATE CURRENT VS. CASE TEMPERATURE

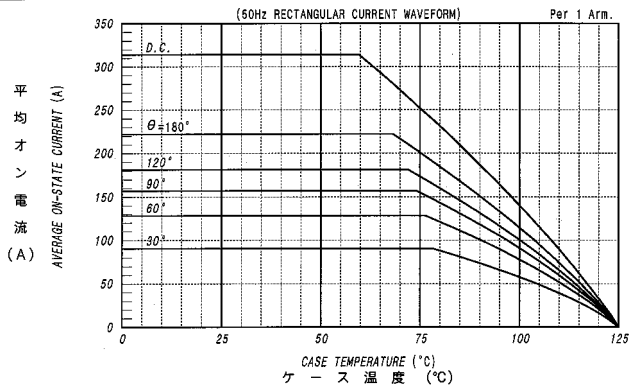

サージオン電流定格
SURGE CURRENT RATINGS

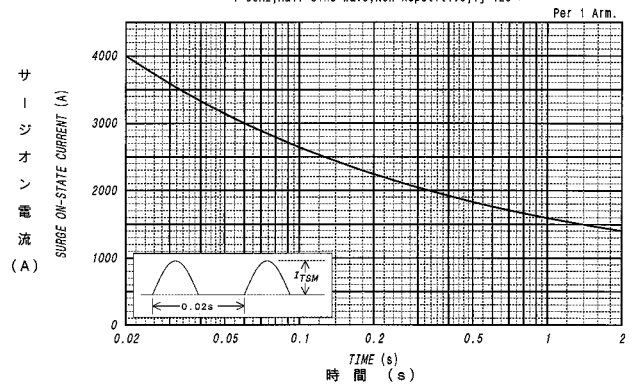

ゲート特性
GATE CHARACTERISTICS

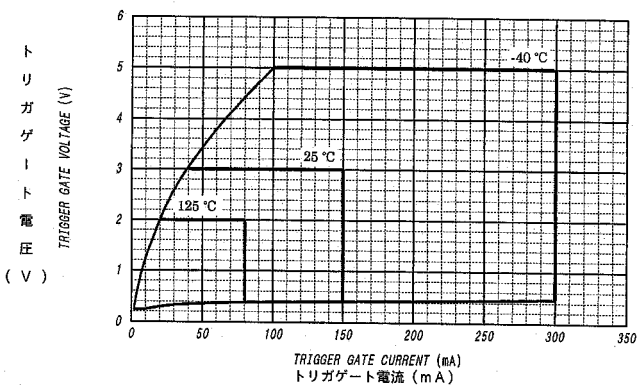

ゲート定格
GATE RATINGS

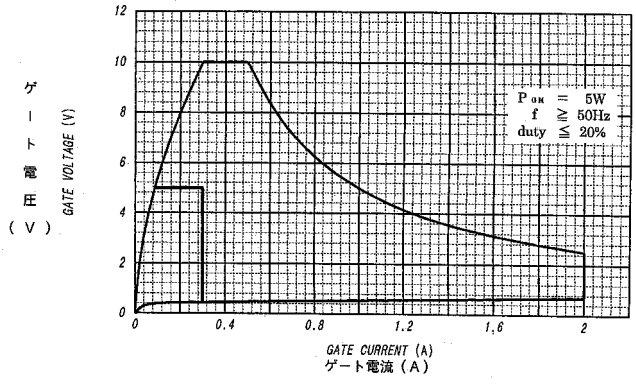

過渡熱抵抗特性
 MAXIMUM TRANSIENT THERMAL IMPEDANCE
 Junction to Case

Per 1 Arm.

