

# THYRISTOR MODULE

## PK(PD,PE,KK)90HB

UL:E76102(M)

Power Thyristor/Diode Module **PK90HB** series are designed for various rectifier circuits and power controls. For your circuit application, following internal connections and wide voltage ratings up to 1,600V are available, and electrically isolated mounting base make your mechanical design easy.

- $I_{T(AV)}$  90A,  $I_{T(RMS)}$  140A,  $I_{TSM}$  1800A
- $di/dt$  200 A/ $\mu$ s
- $dv/dt$  500V/ $\mu$ s

### (Applications)

Various rectifiers  
AC/DC motor drives  
Heater controls  
Light dimmers  
Static switches

### Internal Configurations

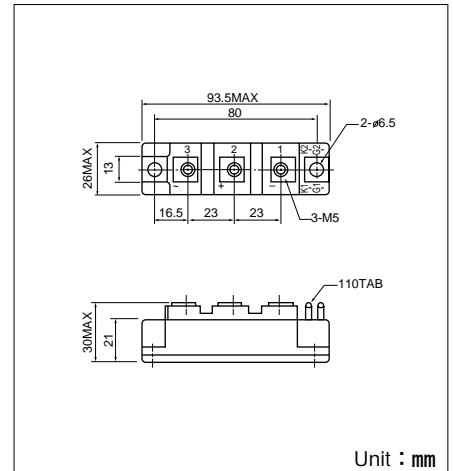
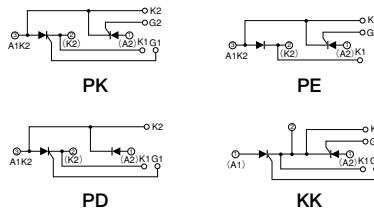

### Maximum Ratings

Symbol	Item	Ratings				Unit
		PK90HB120 KK90HB120	PD90HB120 PE90HB120	PK90HB120 KK90HB120	PD90HB120 PE90HB120	
$V_{RRM}$	* Repetitive Peak Reverse Voltage		1200		1600	V
$V_{RSM}$	* Non-Repetitive Peak Reverse Voltage		1350		1700	V
$V_{DRM}$	Repetitive Peak Off-State Voltage		1200		1600	V

Symbol	Item	Conditions	Ratings	Unit	
$I_{T(AV)}$	* Average On-State Current	Single phase, half wave, 180° conduction, $T_c : 88^\circ\text{C}$	90	A	
$I_{T(RMS)}$	* R.M.S. On-State Current	Single phase, half wave, 180° conduction, $T_c : 88^\circ\text{C}$	140	A	
$I_{TSM}$	* Surge On-State Current	1/2 cycle, 50Hz/60Hz, peak Value, non-repetitive	1650/1800	A	
$I^2t$	* $I^2t$	Value for one cycle of surge current	15000	A <sup>2</sup> S	
$P_{GM}$	Peak Gate Power Dissipation		10	W	
$P_{G(AV)}$	Average Gate Power Dissipation		3	W	
$I_{FGM}$	Peak Gate Current		3	A	
$V_{FGM}$	Peak Gate Voltage (Forward)		10	V	
$V_{RGM}$	Peak Gate Voltage (Reverse)		5	V	
$di/dt$	Critical Rate of Rise of On-State Current	$I_G=100\text{mA}$ , $T_j=25^\circ\text{C}$ , $V_D=1/2V_{DRM}$ , $dI_G/dt=0.1\text{A}/\mu\text{s}$	200	A/ $\mu$ s	
$V_{ISO}$	* Isolation Breakdown Voltage (R.M.S.)	A.C. 1minute	2500	V	
$T_j$	* Operating Junction Temperature		-40 to +125	°C	
$T_{stg}$	* Storage Temperature		-40 to +125	°C	
	Mounting Torque	Mounting (M6)	Recommended Value 2.5-3.9 (25-40)	4.7 (48)	N·m (kgf·cm)
		Terminal (M5)	Recommended Value 1.5-2.5 (15-25)	2.7 (28)	
	Mass			170	g

### Electrical Characteristics

Symbol	Item	Conditions	Ratings	Unit
$I_{DRM}$	Repetitive Peak Off-State Current, max.	at $V_{DRM}$ , single phase, half wave, $T_j=125^\circ\text{C}$	15	mA
$I_{RRM}$	* Repetitive Peak Reverse Current, max.	at $V_{DRM}$ , single phase, half wave, $T_j=125^\circ\text{C}$	15	mA
$V_{TM}$	* Peak On-State Voltage, max.	On-State Current 270A, $T_j=125^\circ\text{C}$ Inst. measurement	1.40	V
$I_{GT}/V_{GT}$	Gate Trigger Current/Voltage, max.	$T_j=25^\circ\text{C}$ , $I_T=1\text{A}$ , $V_D=6\text{V}$	100/2	mA/V
$V_{GD}$	Non-Trigger Gate, Voltage, min.	$T_j=125^\circ\text{C}$ , $V_D=1/2V_{DRM}$	0.25	V
$t_{gt}$	Turn On Time, max.	$I_T=90\text{A}$ , $I_G=100\text{mA}$ , $T_j=25^\circ\text{C}$ , $V_D=1/2V_{DRM}$ , $dI_G/dt=0.1\text{A}/\mu\text{s}$	10	$\mu$ s
$dv/dt$	Critical Rate of Rise of Off-State Voltage, min.	$T_j=125^\circ\text{C}$ , $V_D=2/3V_{DRM}$ , Exponential wave.	500	V/ $\mu$ s
$I_H$	Holding Current, typ.	$T_j=25^\circ\text{C}$	50	mA
$I_L$	Latching Current, typ.	$T_j=25^\circ\text{C}$	100	mA
$R_{th(j-c)}$	* Thermal Impedance, max.	Junction to case	0.30	°C/W

\*mark : Thyristor and Diode part. No mark : Thyristor part

