

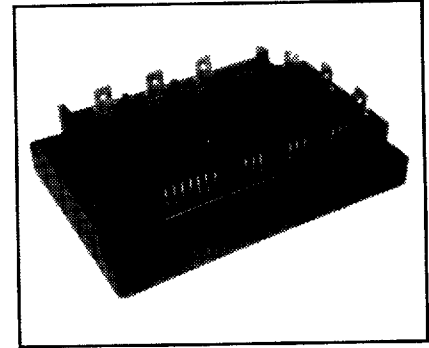

PM50RHB060

Powerex, Inc., Hillis Street, Youngwood, Pennsylvania 15697 (412) 925-7272
 Powerex, Europe, S.A. 428 Avenue G. Durand, BP107, 72003 Le Mans, France (43) 41.14.14

Intellimod™-3 Modules
 Three Phase + Brake
 IGBT Inverter Output
 50 Amperes/110-230 Volt Line

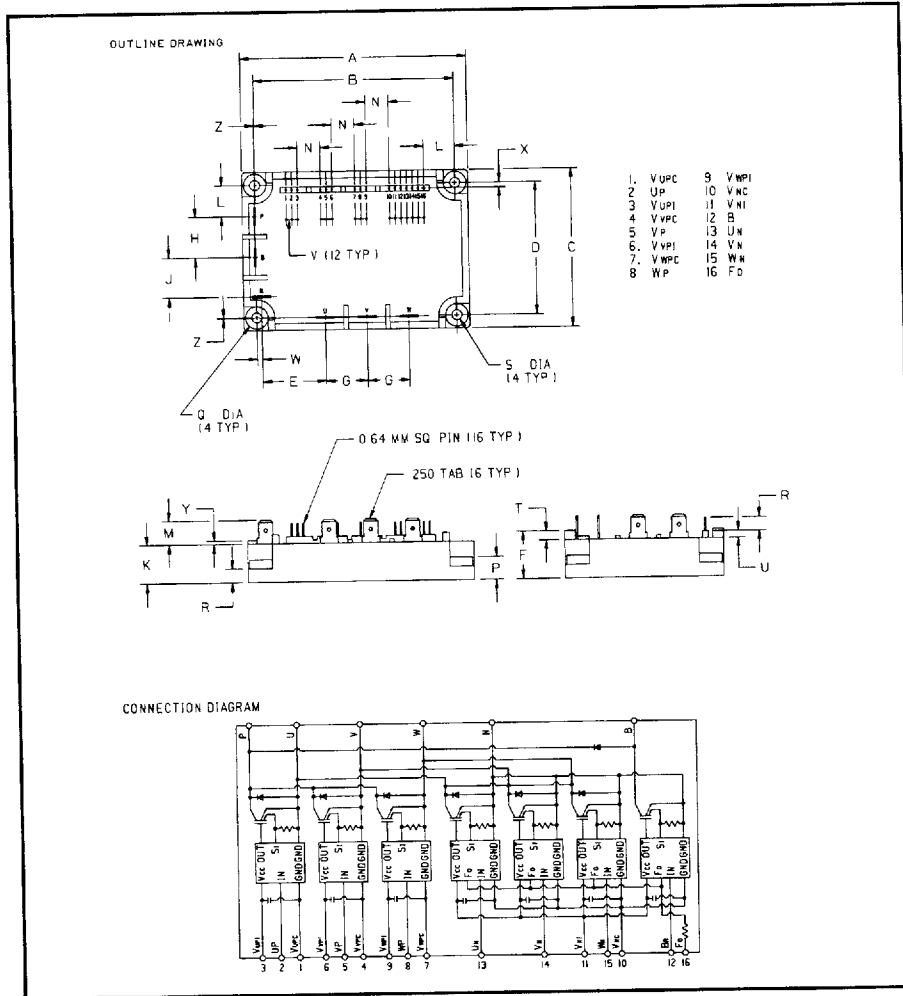

Description

Powerex Intellimod-3 Modules are designed for applications requiring a high frequency (20kHz) output switching inverter. The modules are isolated from the baseplate, consisting of complete drive, control and protection circuitry for the IGBT inverter.

Features:

- Complete Output Power Circuit
- Gate Drive Circuit
- Protection Logic
 - Short Circuit
 - Over-Current
 - Over Temperature
 - Under Voltage

Applications:

- Inverters
- Small UPS
- Motion/Servo Control
- AC Motor Control

Ordering Information
 PM50RHB060

110-230 Volt Line, PM50RHB060 Outline Drawing

Dimensions	Inches	Millimeters
A	3.96±0.04	100.5±1.0
B	3.48±0.02	88.5±0.5
C	2.76±0.04	70.0±1.0
D	2.30±0.02	58.5±0.5
E	1.191	30.25
F	0.83	21.0
G	0.73	18.5
H	0.71	18.0
J	0.69	17.5
K	0.67	17.0
L	0.541	13.75
M	0.41	10.5

Dimensions	Inches	Millimeters
N	0.4	10.16
P	0.39	10.0
Q	0.39 Dia.	10.0 Dia.
R	0.24	6.0
S	0.18 Dia.	4.5 Dia.
T	0.16	4.0
U	0.12	3.0
V	0.1	2.54
W	0.088	2.25
X	0.086	2.18
Y	0.06	1.5
Z	0.001	0.25



POWEREX INC

51E D ■ 7294621 0005687 961 ■ PRX

Powerex, Inc., Hillis Street, Youngwood, Pennsylvania 15697 (412) 925-7272

Powerex, Europe, S.A. 428 Avenue G. Durand, BP107, 72003 Le Mans, France (43) 41.14.14

PM50RHB060

Intellimod-3 Modules

Three Phase + Brake IGBT Inverter Output

50 Amperes/110-230 Volt Line

T-57-29

Absolute Maximum Ratings, $T_j = 25\text{ }^\circ\text{C}$ unless otherwise specified

Characteristics	Symbol	PM50RHB060	Units
Power Device Junction Temperature	T_j	-20 to +150	$^\circ\text{C}$
Storage Temperature	T_{STG}	-40 to +125	$^\circ\text{C}$
Case Operating Temperature	T_C	-20 to +100	$^\circ\text{C}$
Mounting Torque, M4 Mounting Screws	—	15	Kg-cm
Module Weight (Typical)	—	330	Grams
Supply Voltage Protected by OC and SC ($V_D = 13.5 - 16.5\text{V}$, Inverter Part)	$V_{CC(prot.)}$	400	Volts
Isolation Voltage AC 1 minute, 60Hz	V_{RMS}	2500	Volts

Control Sector

Supply Voltage Applied between ($V_{UP1} - V_{UPC}$, $V_{VP1} - V_{VPC}$, $V_{WP1} - V_{WPC}$, $V_{N1} - V_{NC}$)	V_D	20	Volts
Input Voltage Applied between (U_P , V_P , U_N , V_N , W_N , B_r)	V_{CIN}	20	Volts
Fault Output Supply Voltage	V_{FO}	20	Volts
Fault Output Current	I_{FO}	20	mA

IGBT Inverter Sector

Collector-Emitter Voltage Fig. 1	V_{CES}	600	Volts
Collector Current \pm	I_C	50	Amperes
Peak Collector Current \pm	I_{CP}	100	Amperes
Supply Voltage (Applied between P - N)	V_{CC}	400	Volts
Supply Voltage (Surge) Applied between P - N	$V_{CC(surge)}$	500	Volts
Collector Dissipation	P_C	138	Watts

Brake Sector

Collector-Emitter Voltage Fig. 1	V_{CES}	600	Volts
Collector Current \pm	I_C	15	Amperes
Peak Collector Current \pm	I_{CP}	30	Amperes
Supply Voltage (Applied between P - N)	V_{CC}	400	Volts
Supply Voltage (Surge) Applied between P - N	$V_{CC(surge)}$	500	Volts
Collector Dissipation	P_C	52	Watts
Diode Forward Current	I_F	15	Amperes
Diode DC Reverse Voltage	$V_{R(DC)}$	600	Volts

PM50RHB060
Intellimod-3 Modules
Three Phase + Brake IGBT Inverter Output
 50 Amperes/110-230 Volt Line

Electrical Characteristics, $T_j = 25\text{ }^\circ\text{C}$ unless otherwise specified

Characteristics	Symbol	Test Conditions	Min.	Typ.	Max.	Units
Control Sector						
Overcurrent Trip Level Inverter Part	OC	$-20^\circ\text{C} \leq T \leq 125^\circ\text{C}$, $V_D = 15\text{V}$	65	88	—	Amperes
Overcurrent Trip Level Brake Part			18	26	—	Amperes
Short Circuit Trip Level Inverter Part	SC	$-20^\circ\text{C} \leq T \leq 125^\circ\text{C}$, $V_D = 15\text{V}$	—	132	—	Amperes
Short Circuit Trip Level Brake Part			—	39	—	Amperes
Over Current Delay Time	$t_{\text{off(OC)}}$	$V_D = 15\text{V}$, Fig. 7	—	10	—	μS
Over Temperature Protection	OT	Trip Level	111	118	125	$^\circ\text{C}$
Over Temperature Protection	OT_R	Reset Level	—	100	—	$^\circ\text{C}$
Supply Circuit Under Voltage Protection	UV	Trip Level	11.5	12.0	12.5	Volts
Supply Circuit Under Voltage Protection	UV_R	Reset Level	—	12.5	—	Volts
Supply Voltage	V_D	Applied between $V_{\text{UP1}} - V_{\text{UPC}}$, $V_{\text{VP1}} - V_{\text{VPC}}$, $V_{\text{WP1}} - V_{\text{WPC}}$, $V_{\text{N1}} - V_{\text{NC}}$	13.5	15	16.5	Volts
Circuit Current	I_D	$V_D = 15\text{V}$, $V_{\text{CIN}} = 15\text{V}$, $V_{\text{N1}} - V_{\text{NC}}$	—	80	120	mA
	I_D	$V_D = 15\text{V}$, $V_{\text{CIN}} = 15\text{V}$, $V_{\text{XP1}} - V_{\text{XPC}}$	—	25	35	mA
Input On Voltage	$V_{\text{CIN(on)}}$	Applied between $V_{\text{UP1}} - V_{\text{UPC}}$, $V_{\text{VP1}} - V_{\text{VPC}}$, $V_{\text{WP1}} - V_{\text{WPC}}$, $V_{\text{N1}} - V_{\text{NC}}$, $B_r - V_{\text{NC}}$	1.2	1.5	1.8	Volts
Input Off Voltage	$V_{\text{CIN(off)}}$	Applied between $V_{\text{UP1}} - V_{\text{UPC}}$, $V_{\text{VP1}} - V_{\text{VPC}}$, $V_{\text{WP1}} - V_{\text{WPC}}$, $V_{\text{N1}} - V_{\text{NC}}$, $B_r - V_{\text{NC}}$	1.7	2.0	2.3	Volts
PWM Input Frequency	f_{PWM}	3- \emptyset Sinusoidal	—	15	20	kHz
Dead Time	t_{DEAD}	For each Input Pulse	3.0	—	—	μS
		Using example Interface Circuit*	5.0	—	—	μS
Fault Output Current	$I_{\text{FO(H)}}$	$V_D = 15\text{V}$, $V_{\text{FO}} = 15\text{V}$	—	—	0.01	mA
	$I_{\text{FO(L)}}$	$V_D = 15\text{V}$, $V_{\text{FO}} = 15\text{V}$	—	10	15	mA
Minimum Fault Output Pulse Width	t_{FO}	$V_D = 15\text{V}$	1.0	2.0	—	mS
		Using example Interface Circuit* $V_D = 15\text{V}$	1.5	2.0	—	mS
Brake Sector						
Collector Emitter Saturation Voltage	$V_{\text{CE(sat)}}$	$V_D = 15\text{V}$, $I_C = 15\text{A}$, $T_j = 25^\circ\text{C}$, Fig. 2	—	2.6	3.5	Volts
		$V_D = 15\text{V}$, $I_C = 15\text{A}$, $T_j = 125^\circ\text{C}$, Fig. 2	—	3.0	4.0	Volts
		$V_D = 15\text{V}$, $I_C = 15\text{A}$, $V_{\text{CIN}} = 15\text{V}$, Fig. 3	—	1.7	2.2	Volts
Diode Forward Voltage	V_{FM}	$I_C = 15\text{A}$, $V_D = 15\text{V}$, $V_{\text{CIN}} = 15\text{V}$, Fig. 3	—	1.7	2.2	Volts
Collector Cutoff Current	I_{CEX}	$V_{\text{CE}} = V_{\text{CES}}$, $T_j = 25^\circ\text{C}$, Fig. 6	—	—	1	mA
		$V_{\text{CE}} = V_{\text{CES}}$, $T_j = 125^\circ\text{C}$, Fig. 6	—	—	10	mA

*See Intellimod-3 Applications Data Section 4.3.



POWEREX INC

51E D ■ 7294621 0005689 734 ■ PRX

Powerex, Inc., Hillis Street, Youngwood, Pennsylvania 15697 (412) 925-7272
 Powerex, Europe, S.A. 428 Avenue G. Durand, BP107, 72003 Le Mans, France (43) 41.14.14

T-57-29

PM50RHB060
Intellimod-3 Modules
Three Phase + Brake IGBT Inverter Output
 50 Amperes/110-230 Volt Line

Electrical Characteristics, $T_J = 25^\circ\text{C}$ unless otherwise specified

Characteristics	Symbol	Test Conditions	Min.	Typ.	Max.	Units
IGBT Inverter Sector						
Collector Cutoff Current	I_{CEX}	$V_{CE} = V_{CES}, T_J = 25^\circ\text{C}$, Fig. 6	-	-	1	mA
Collector Cutoff Current	I_{CEX}	$V_{CE} = V_{CES}, T_J = 125^\circ\text{C}$, Fig. 6	-	-	10	mA
Diode Forward Voltage	V_{FM}	$-I_C = 50\text{A}, V_D = 15\text{V}, V_{CIN} = 15\text{V}$, Fig. 3	-	1.7	2.5	Volts
Collector Emitter Saturation Voltage	$V_{CE(sat)}$	$V_D = 15\text{V}, V_{CIN} = 0\text{V}, T_J = 25^\circ\text{C}$, $I_C = 50\text{A}$, Fig. 2	-	2.7	3.5	Volts
Collector Emitter Saturation Voltage	$V_{CE(sat)}$	$V_D = 15\text{V}, V_{CIN} = 0\text{V}, T_J = 150^\circ\text{C}$, $I_C = 50\text{A}$, Fig. 2	-	2.5	3.4	Volts
Inductive Load Switching Times	t_{on}	$V_D = 15\text{V}, V_{CIN} = 0\text{V}$, $V_{CC} = 300\text{V}, I_C = 50\text{A}$, $T_J = 125^\circ\text{C}$ Fig. 4, 5	0.3	0.6	1.5	μS
	t_{rr}		-	0.25	0.4	μS
	$t_{C(on)}$		-	0.4	1.2	μS
	t_{off}		-	2.0	3.3	μS
	$t_{C(off)}$		-	0.6	1.2	μS

Thermal Characteristics

Characteristics	Symbol	Test Conditions	Min.	Typ.	Max.	Units
Thermal Resistances Junction to Case	$R_{th(I-S)Q}$	Inverter IGBT	-	-	0.9	$^\circ\text{C/W}$
	$R_{th(I-e)F}$	Inverter FWD	-	-	2.5	$^\circ\text{C/W}$
	$R_{th(I-e)Q}$	Brake IGBT	-	-	2.4	$^\circ\text{C/W}$
	$R_{th(I-e)F}$	Brake FWD	-	-	4.5	$^\circ\text{C/W}$
Contact Thermal Resistance	$R_{th(c-f)}$	Case to Fin, Thermal Grease Applied	-	-	0.25	$^\circ\text{C/W}$

Recommended Operating Conditions

Characteristics	Symbol	Test Conditions	Value	Units
Supply Voltage	V_{CC}	Applied across P - N Terminals	0 ~ 400	Volts
	V_D	Applied between $V_{UP1} - V_{UPC}$, $V_{N1} - V_{NC}$, $V_{VP1} - V_{VPC}$, $V_{WP1} - V_{WPC}$	15±1.5	Volts
Input On Voltage	$V_{CIN(on)}$	Applied between	0 ~ 0.8	Volts
Input Off Voltage	$V_{CIN(off)}$	$U_P, V_P, W_P, U_N, V_N, W_N, B_r$	4.0 ~ 15	Volts
PWM Input Frequency	f_{PWM}	Using example Interface Circuit *	5 ~ 20	kHz
Minimum Dead Time	t_{DEAD}	Using example Interface Circuit *	5.0	μS

*See Intellimod-3 Applications Data Section 4.3.

PM50RHB060

Intellimod-3 Modules

Three Phase + Brake IGBT Inverter Output

50 Amperes/110-230 Volt Line

Inverter Part

SATURATION VOLTAGE CHARACTERISTICS (TYPICAL)

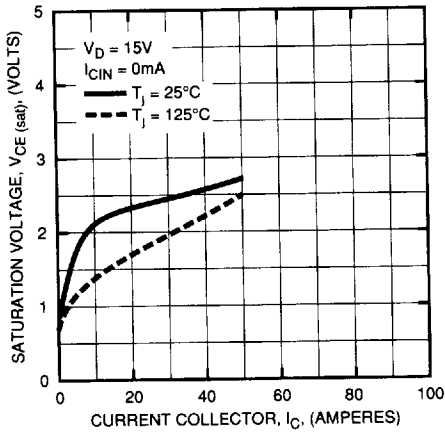

COLLECTOR-EMITTER SATURATION VOLTAGE (TYPICAL)

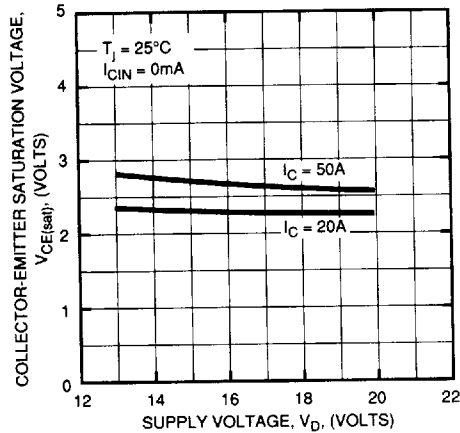

OUTPUT CHARACTERISTICS (TYPICAL)

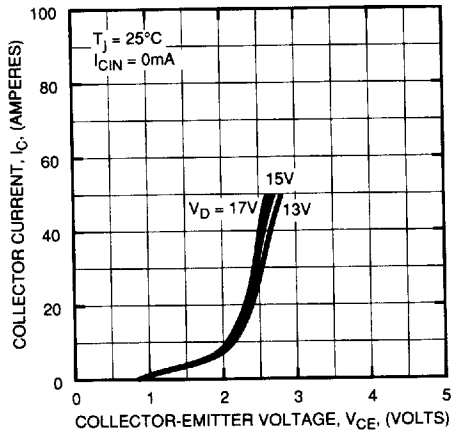

SWITCHING TIME VS. COLLECTOR CURRENT (TYPICAL)

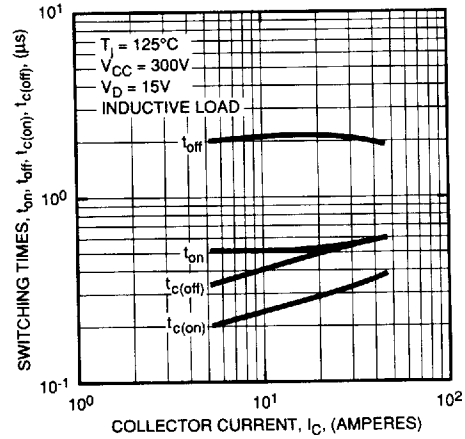

REVERSE RECOVERY CHARACTERISTICS OF FREE-WHEEL DIODE (TYPICAL)

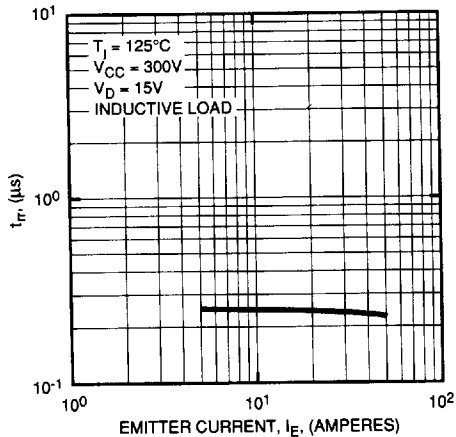

REVERSE COLLECTOR CURRENT VS. EMITTER-COLLECTOR VOLTAGE (DIODE FORWARD CHARACTERISTICS) (TYPICAL)

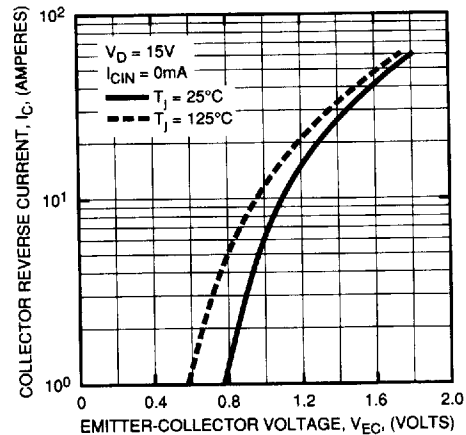



POWEREX INC

51E D ■ 7294621 0005691 392 ■ PRX

Powerex, Inc., Hillis Street, Youngwood, Pennsylvania 15697 (412) 925-7272

Powerex, Europe, S.A. 428 Avenue G. Durand, BP107, 72003 Le Mans, France (43) 41.14.14

PM50RHB060

Intellimod-3 Modules

Three Phase + Brake IGBT Inverter Output

50 Amperes/110-230 Volt Line

Inverter Part

T-57-29

POWER DISSIPATION DERATING CURVE (PER IGBT ELEMENT)

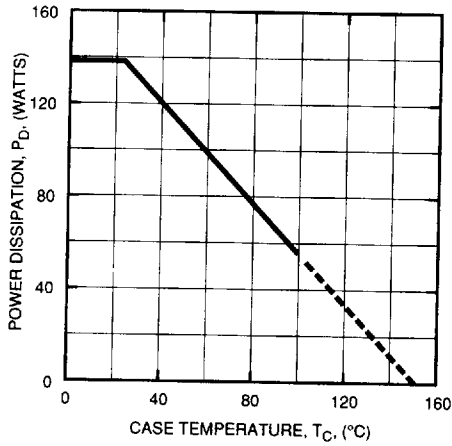

POWER DISSIPATION DERATING CURVE (PER FWDI ELEMENT)

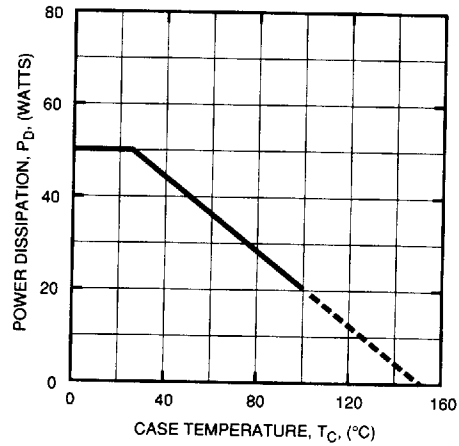

TRANSIENT THERMAL IMPEDANCE CHARACTERISTICS (IGBT)

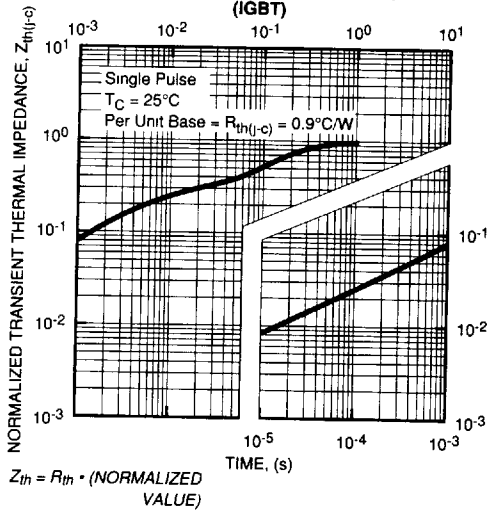

TRANSIENT THERMAL IMPEDANCE CHARACTERISTICS (FWDI)

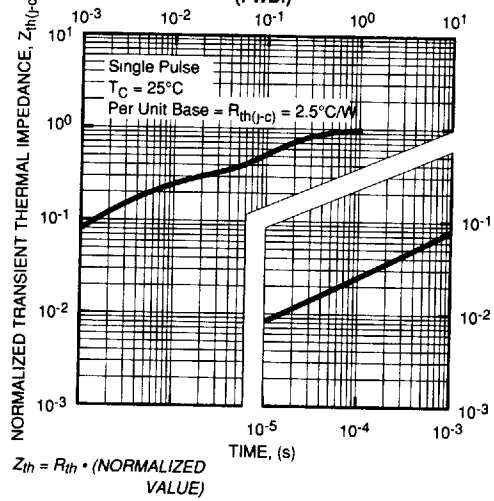

T-57-29

PM50RHB060
Intellimod-3 Modules
Three Phase + Brake IGBT Inverter Output
 50 Amperes/110-230 Volt Line
Brake Part

SATURATION VOLTAGE CHARACTERISTICS (TYPICAL)

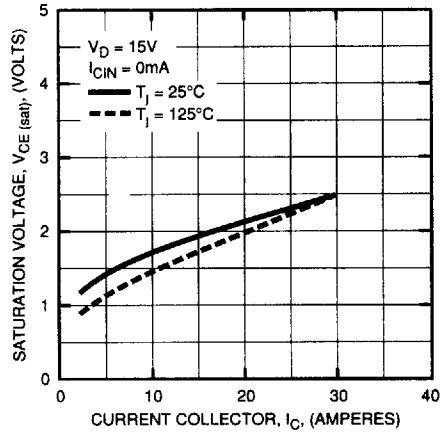

COLLECTOR-EMITTER SATURATION VOLTAGE (TYPICAL)

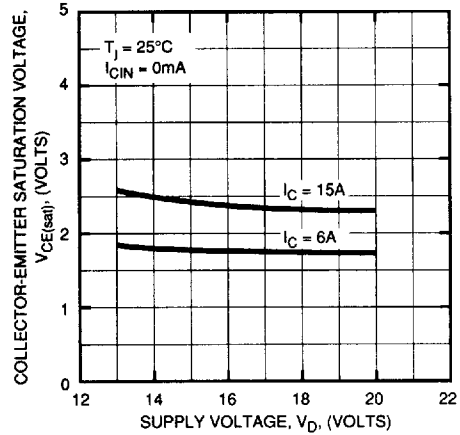

OUTPUT CHARACTERISTICS (TYPICAL)

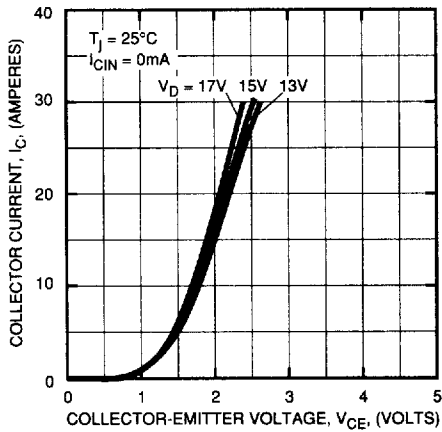

REVERSE COLLECTOR CURRENT VS. EMITTER-COLLECTOR VOLTAGE (DIODE FORWARD CHARACTERISTICS) (TYPICAL)

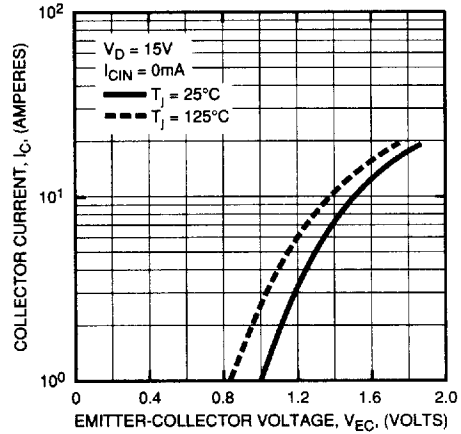

PM50RHB060

Intellimod-3 Modules

Three Phase + Brake IGBT Inverter Output

50 Amperes/110-230 Volt Line

Brake Part

**POWER DISSIPATION DERATING CURVE
(PER IGBT ELEMENT)**

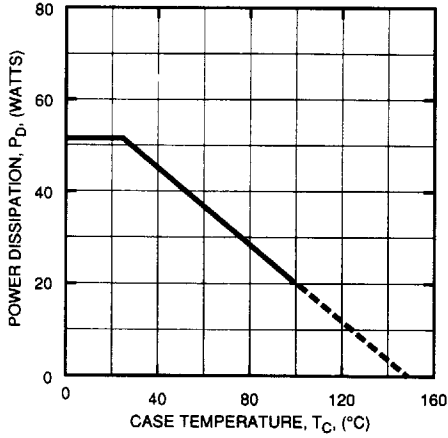

**POWER DISSIPATION DERATING CURVE
(PER FWDI ELEMENT)**

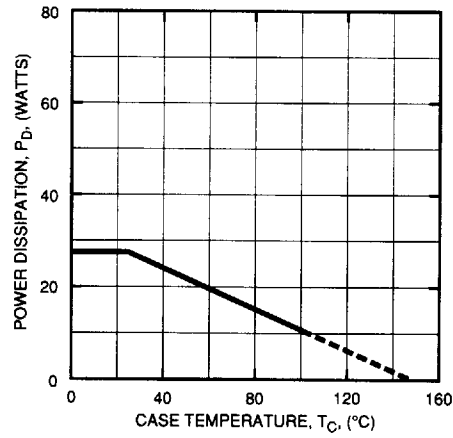

**TRANSIENT THERMAL
IMPEDANCE CHARACTERISTICS
(IGBT)**

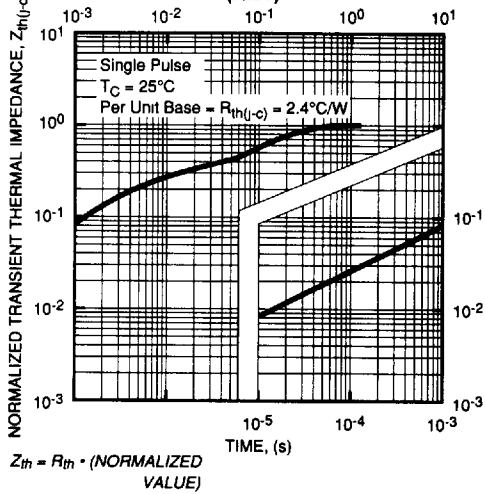

**TRANSIENT THERMAL
IMPEDANCE CHARACTERISTICS
(FWDI)**

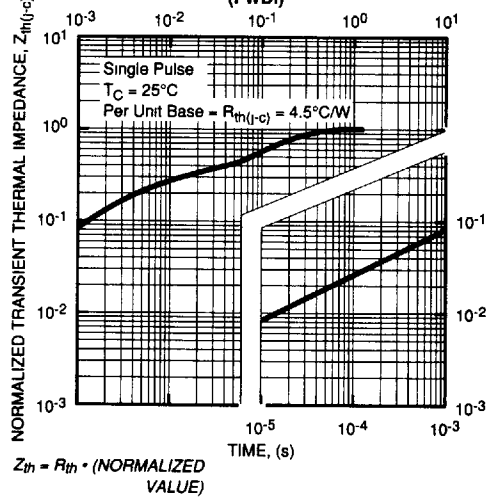

T-57-29

PM50RHB060
Intellimod-3 Modules
Three Phase + Brake IGBT Inverter Output
 50 Amperes/110-230 Volt Line

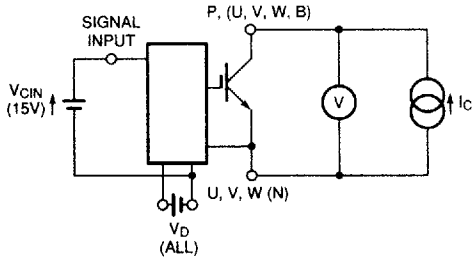

Figure 1 V_{CES} Test

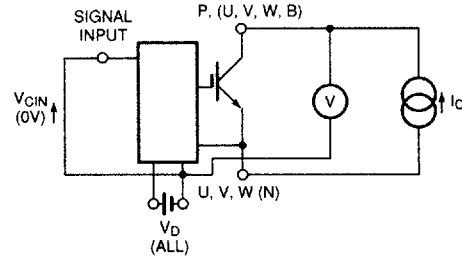

Figure 2 $V_{CE(SAT)}$ Test

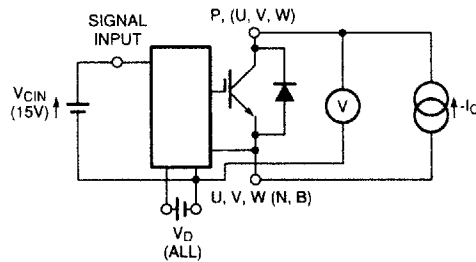
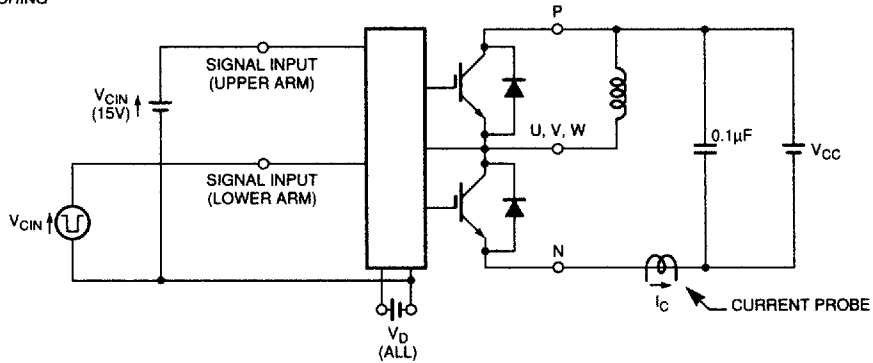

Figure 3 V_{EC} Test

A) LOWER ARM SWITCHING



B) UPPER ARM SWITCHING

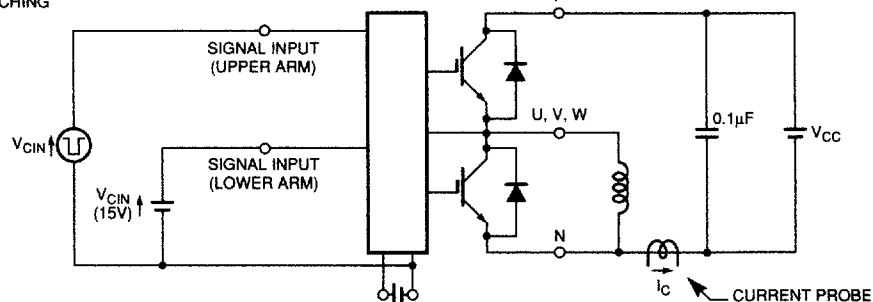

Figure 4 Switching Time Test

PM50RHB060
Intellimod-3 Modules
Three Phase + Brake IGBT Inverter Output
 50 Amperes/110-230 Volt Line

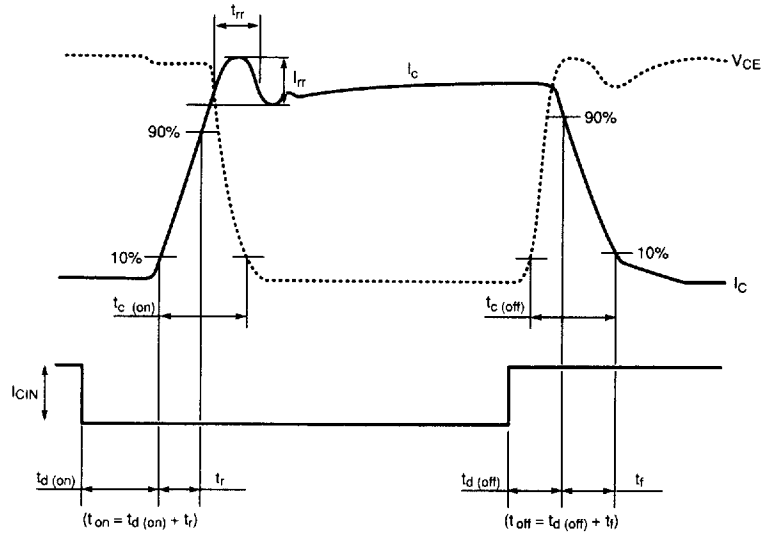

Figure 5 Switching Test Waveform

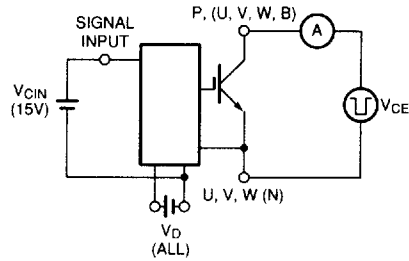

Figure 6 ICES Test

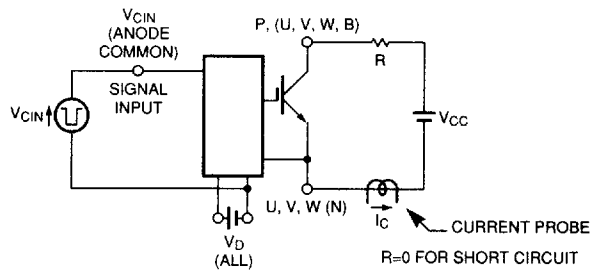

Figure 7 Over Current and Short Circuit Test